

## K-BUS® Push Button Sensor with LCD, 55mm\_V1.0

**CHPBL-03/00.1.00 (White glossy finish)**

**CHPBL-03/00.2.00 (White matt finish)**

**CHPBL-03/00.2.01 (Black matt finish)**

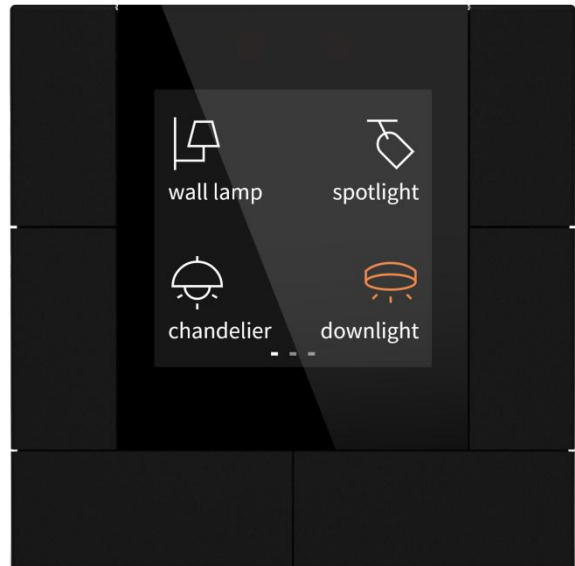

**KNX/EIB Home and Building Control System**

# Attentions

**1. Please keep devices away from strong magnetic field, high temperature, wet environment;**



**2. Do not fall the device to the ground or make them get hard impact;**



**3. Do not use wet cloth or volatile reagent to wipe the device;**



**4. Do not disassemble the devices.**

# Contents

Chapter 1 Summary	1
Chapter 2 Technical Data	2
Chapter 3 Dimension and Structural Diagram	3
3.1. Dimension Diagram	3
3.2. Structural Diagram	3
Chapter 4 Project Design and Programming	4
Chapter 5 Parameter setting description in the ETS	6
5.1. KNX Secure	6
5.2. Parameter window “General”	10
5.2.1. Parameter window “Setting page guideline”	10
5.2.2. Parameter window “General setting”	10
5.2.3. Parameter window “Screen saver setting”	16
5.2.4. Parameter window “Night mode setting”	19
5.2.5. Parameter window “Summer time setting”	22
5.2.6. Parameter window “Proximity setting”	24
5.2.7. Parameter window “Alarm setting”	25
5.2.8. Parameter window “Advanced setting”	27
5.3. Parameter window “Internal sensor measurement”	28
5.4. Parameter window “Input”	32
5.4.1. Temperature probe	33
5.4.2. Binary input	35
5.5. Parameter window “Function setting”	40
5.5.1. Parameter window “Push button sensor”	41
5.5.2. Parameter window “Multifunction thermostat”	95
5.5.3. Parameter window “Audio control”	149
5.6. Parameter window “Logic”	154
5.6.1. Parameter window “AND/OR/XOR”	155
5.6.2. Parameter window “Gate forwarding”	157
5.6.3. Parameter window “Threshold comparator”	159
5.6.4. Parameter window “Format convert”	161
5.6.5. Parameter window “Gate function”	162
5.6.6. Parameter window “Delay function”	164
5.6.7. Parameter window “Staircase lighting”	164
5.7. Parameter window “Scene Group”	166
Chapter 6 Description of Communication Object	168
6.1. “General” Communication Object	168
6.2. “Internal sensor measurement” Communication Object	172
6.3. “Input” Communication Object	173
6.4. “Push button sensor” Communication Object	175

6.5. “Multifunction thermostat” Communication Object	187
6.5.1. “FCU” Communication Object	187
6.5.2. “VRF” Communication Object	193
6.5.3. “Floor heating” Communication Object	195
6.5.4. “Ventilation” Communication Object	197
6.6. “Audio control” Communication Object	200
6.7. “Logic” Communication Object	204
6.7.1. “AND/OR/XOR” Communication Object	204
6.7.2. “Gate forwarding” Communication Object	204
6.7.3. “Threshold comparator” Communication Object	205
6.7.4. “Format convert” Communication Object	206
6.7.5. “Gate function” Communication Object	208
6.7.6. “Delay function” Communication Object	209
6.7.7. “Staircase lighting” Communication Object	209
6.8. “Scene Group” Communication Object	210
Chapter 7 UI Description	211
7.1. Push button sensor	211
7.1.1. RGB dimming	213
7.1.2. RGBW dimming	214
7.1.3. Colour temperature dimming	215
7.2. Multifunction thermostat	216
7.2.1. FCU control page	216
7.2.2. VRF control page	218
7.2.3. Floor heating page	220
7.2.4. Ventilation page	222
7.3. Audio control page	224
7.4. Screen saver	226
7.5. Setting page	226
7.6. Other	228
Chapter 8 Icon list	229
8.1. Icon list for push button sensor	229
8.2. Icon list for multifunction thermostat	233

## Chapter 1 Summary

Push Button Sensor with LCD, 55mm is mainly applied in building control system, connected to the bus via KNX connection terminals and installed together with other devices on the bus to become a system. It's functionally simple and intuitive to operate. Users can plan according to their own needs to perform these functions in the system.

Push Button Sensor with LCD, 55mm is designed based on the European standard 55mm system as any other European KNX manufacturers, which means it can be used in Push button sensor, Multifunction thermostat, and Audio control.

The manual provides detailed technical information about the Push Button Sensor with LCD, 55mm, including installation and programming details, and explains how to use the panel in conjunction with examples in actual use.

Push Button Sensor with LCD, 55mm is powered via KNX bus, mounted in a standard 80 or 86-box wall mount. The physical address assignment and parameter settings can be used with the engineering tool software ETS (version ETS5.7 or above) with the .knxprod file.

The functions are summarized as follows:

- Panel lock, Proximity sense, Screen saver, Alarm function, Internal temperature / humidity sensor
- Display the function and status of buttons, optional with icon, text, status value etc.
- Push button sensor: select individual or rocker button, up to set 12 buttons
- Individual button support Switch, Dimming, RGB, RGBW, Colour temperature control, Value sender, Scene, Blind, Shift register, Multiple operation, Delay mode, RTC operation mode, String, Status display
- Rocker button only support Switch, Dimming, Scene, Blind, Setpoint adjustment
- Multifunction thermostat: Room temperature control function (Select FCU control or VRF control), Floor heating and Ventilation function. Each with 5 scenes, all can be set to function lock
- Audio function, support to display name, switch tracks, adjust volume and configure play mode
- Support 2 external input interfaces, used as dry contact detection or NTC temperature detection
- Support 8 Scene Group functions, and 8 outputs for per Scene Group
- Support 8 Logic functions, with AND, OR, XOR, Gate forwarding, Threshold comparator, Format convert, Gate function, Delay function and Staircase lighting

## Chapter 2 Technical Data

<b>Power Supply</b>	Bus voltage	21-30V DC, via the KNX bus
	Bus current	<18mA, 24V; <15mA, 30V
	Bus consumption	<450mW
<b>Input</b>	2 external inputs, as dry contact input or 10K NTC input	
<b>Connection</b>	KNX	Bus connection terminal
	Input	A three-wires connection terminal, cable length <5m
<b>Operation and display</b>	Programming button and red LED	For assigning the physical address, LED off after download
	Orientation LED	Light up when screen off, to indicate device position
	<b>Proximity sensor</b>	Normal sensitivity approximately 15cm Enhanced sensitivity approximately 30cm
<b>Temperature</b>	Operation	- 5 °C ... 45 °C
	Storage	- 25 °C ... 55 °C
	Transport	- 25 °C ... 70 °C
<b>Environment</b>	Humidity	<93%, except dewing
<b>Dimension</b>	76.8 x 76.8 x 19.3 mm	
<b>Mounting</b>	In a conventional 80 or 86 mm wring box	
<b>Mounting</b>	0.05kg	

## Chapter 3 Dimension and Structural Diagram

### 3.1.Dimension Diagram

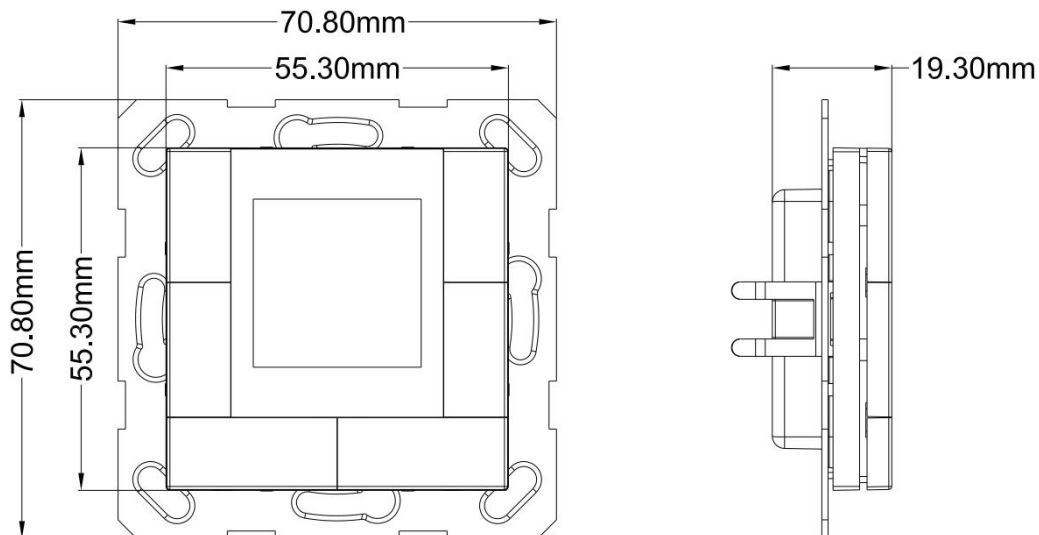

### 3.2.Structural Diagram

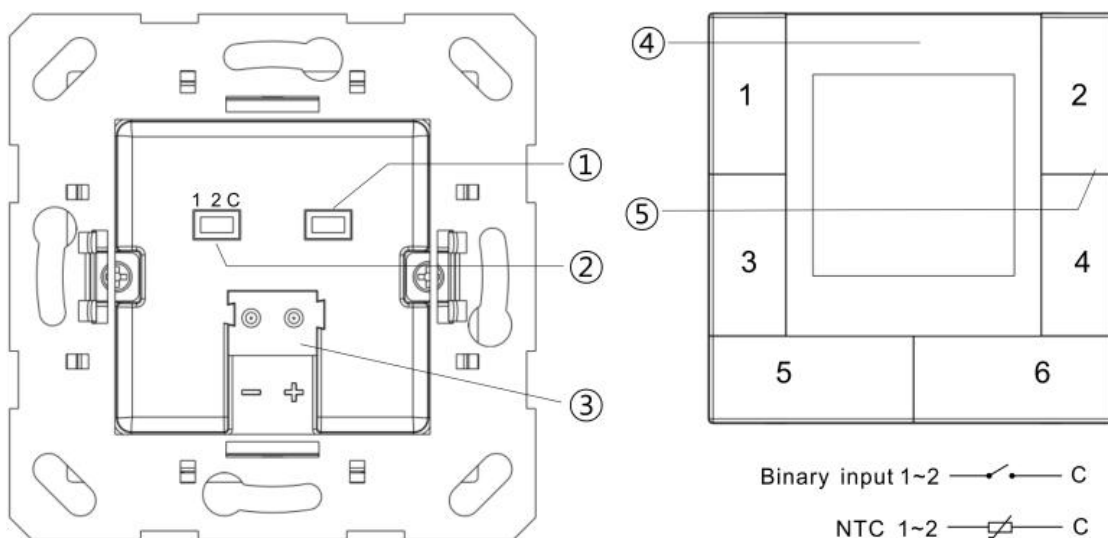

- ① Programming button and LED
- ② Input terminals
- ③ KNX bus connection terminal
- ④ Proximity sensor, Orientation LED
- ⑤ Internal temperature / humidity sensor

**Note:** Press the button2 + button5 at the same time for 5 seconds to enter the setting page, then press button3 to switchover programming mode status

**Reset the device to the factory configuration:** press the programming button and hold for 4 seconds then release, repeat the operation for 4 times, and the interval between each operation is less than 3 seconds

## Chapter 4 Project Design and Programming

Application	Maximum of communication objects	Maximum number of group addresses	Maximum number of associations	Secure group addresses
Push Button Sensor with LCD,55mm/1.0	356	500	500	338

### General function

General function includes device In operation setting, date and time update, request device status after voltage recovery, and supports to lock the whole device.

Support to set other functions, including screen brightness, screen saver, proximity sense and alarm function.

### Internal temperature and humidity measurement

Internal temperature and humidity measurement value is sent to the bus: respond after read only and respond after change.

Set temperature and humidity calibration, and send alarm telegram when the preset range of threshold value for temperature alarm is exceeded.

### External input interface function

Up to support 2 channels, enable/disable each channel functions. Optional dry contact detection or NTC temperature detection.

When selecting dry contact detection, only supports the basic functions, including switch, scene send strings (press/release, short/long, send after voltage recovery, disable function).

When selecting NTC temperature detection, the external temperature probe can be connected to detect the external temperature and the B value data of temperature sensing probe needs to be set.

### Button function

Push button sensor can be used as individual or rocker button, up to support 12 buttons. You can set for each button to display on screen with the icon, text, status and etc.

When used as individual button, you can configure: Switch, Dimming, RGB lighting, RGBW lighting, Colour temperature control, Value sender, Scene control, Blind, Shift register, Multiple operation, Delay mode,



RTC operation mode, String(14bytes), Status display.

When used as rocked button, you can configure: Switch, Dimming, Scene control, Blind, Setpoint adjustment.

## **Room temperature control function**

FCU control: support to control mode input, heating/cooling system, operation mode and setpoint temperature, fan speed, window contact, presence detector, temperature threshold, 2 points and PI control algorithm and etc.;

VRF control: only to be suitable for VRF system, it needs to be controlled with the KNX to VRF air conditioner gateway, support to power on/off, setpoint temperature, mode, fan peed, vanes swing and etc.

Floor heating function: support to 2-point control and PI control to automatically switch floor heating according to temperature difference. In addition, it supports to the scene functions configuration and the setpoint temperature range adjustment.

Ventilation system: support auto control, it is linkage control with PM2.5/CO2/VOC. And support the output types of 1bit of 1byte.

**Note: FCU control and VRF control can only choose one of them.**

**Each of the above functions comes with 5 scenes, all of which can be set for function locking, and support to delay time for exiting setting status, you can select °C or °F as the temperature unit.**

## **Audion function**

It is used to control background music playing, for example, power on/off, play/pause, previous song/next song, volume increase/decrease, mute, play modes, track name, artist name, album name, and so on.

## **Logic function**

Up to support 8 channels of logic, each channel up to support 8 inputs and 1 logic result.

Logic function support functions, including AND, OR, XOR, Gate forwarding, Threshold comparator, Format convert, Delay function and Staircase lighting.

## **Scene group function**

Up to support 8 channels of scene group forward, each group up to support 8 configurable output, datatype is optional 1bit/1byte/2byte.

## Chapter 5 Parameter setting description in the ETS

### 5.1. KNX Secure

Push Button Sensor with LCD, 55mm is a KNX device that complies with the KNX secure standard. That is, you can run the device in safe way.



Fig.5.1 (1) “KNX Secure” parameter window

The device with KNX secure will be displayed notes on ETS, as shown as Fig.5.1(1).

If secure commissioning is activated in ETS project, the following information must be considered during device debugging:

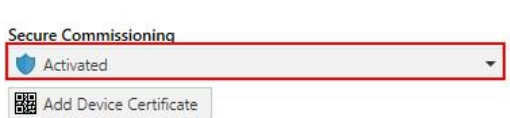

❖ It is essential to assign a project password as soon as a KNX Secure device is imported into a project. This will protect the project against unauthorized access.

**The password must be kept in a safe place – access to the project is not possible without it (not even the KNX Association or device manufacturer will be able to access it)!**

**Without the project password, the commissioning key will not be able to be imported.**

❖ A commissioning key is required when commissioning a KNX Secure device (first download). This key (FDSK = Factory Default Setup Key) is included on a sticker on the side of the device, and it must be imported into the ETS prior to the first download:

❖ On the first download of the device, a window pops up in the ETS to prompt the user to enter the key, as shown in Fig.5.1 (2) below.

The certificate can also be read from the device using a QR scanner (recommended).

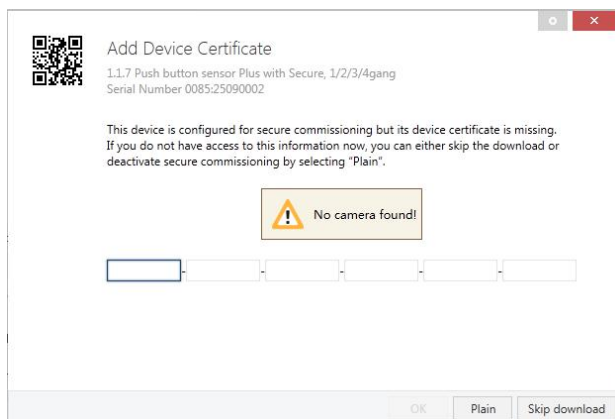

Fig.5.1(2) Add Device Certificate window

✧ Alternatively, the certificates of all Secure devices can be entered in the ETS beforehand.

This is done on the “Security” tab on the project overview page, as shown in Fig.5.1(3) below.

The certificates can be also added to the selected device in the project, as shown in Fig.5.1(4).

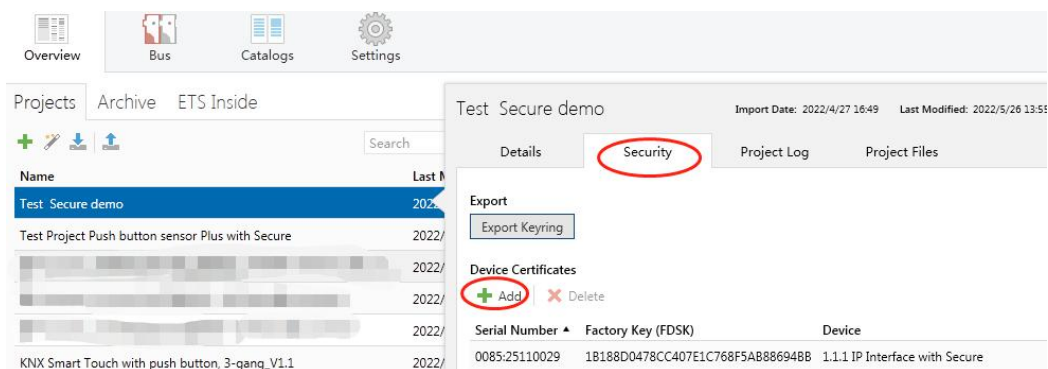

Fig.5.1(3) Add Device Certificate

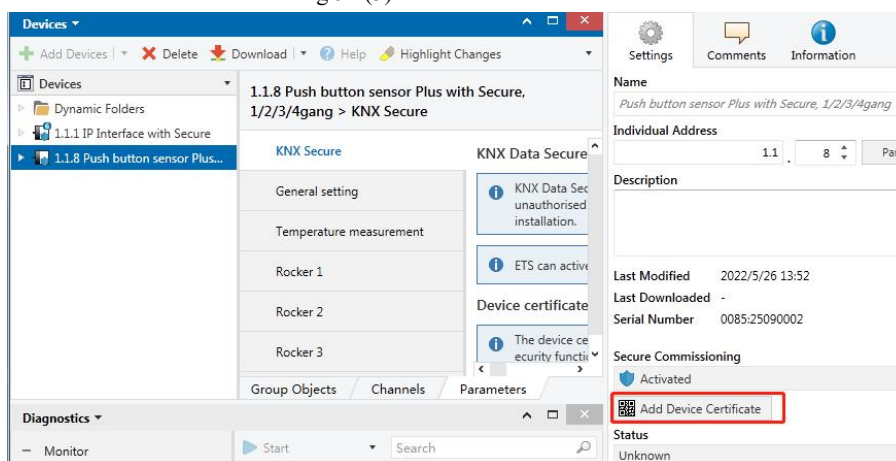

Fig.5.1(4) Add Device Certificate

✧ There is a FDSK sticker on the device, which is used for viewing FDSK number.

**Without the FDSK, it will no longer be possible to operate the device in KNX Secure mode after a reset.**

The FDSK is required only for initial commissioning. After entering the initial FDSK, the ETS will assign a

new key, as shown in Fig.5.1(5) below.

The FDSK will be required again only if the device was reset to its factory settings (e.g. If the device is to be used in a different ETS project).

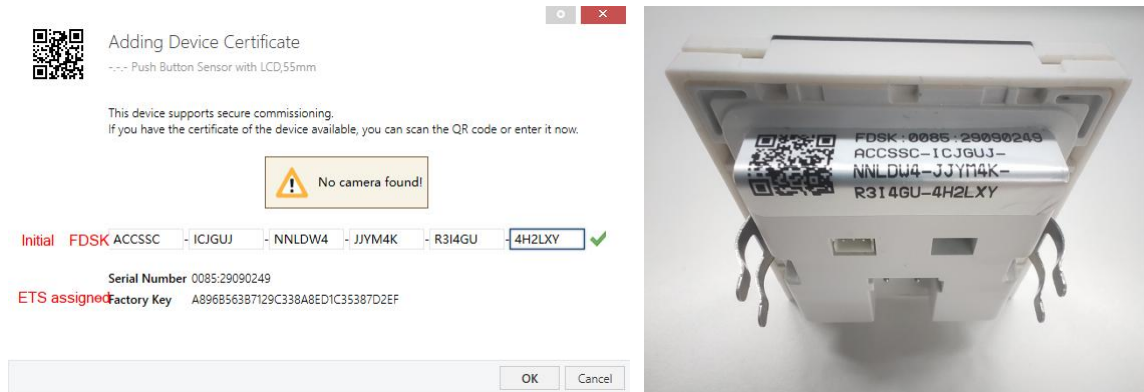

Fig.5.1(5)

Example:

If this application in the project needs to be tried with another device, it is no longer the original device. When the application is downloaded to a new device, the following prompt will appear on the left of Fig.5.1(6), click yes, the Add Device Certificate window will appear, then enter the initial FDSK of the new device, and you need to reset the device to the factory settings (it is not required if the device is still factory default; If it has been used, it will be required to reset, otherwise the following error message will appear on the right of Fig.5.1(6)), and then the device can be successfully downloaded again.

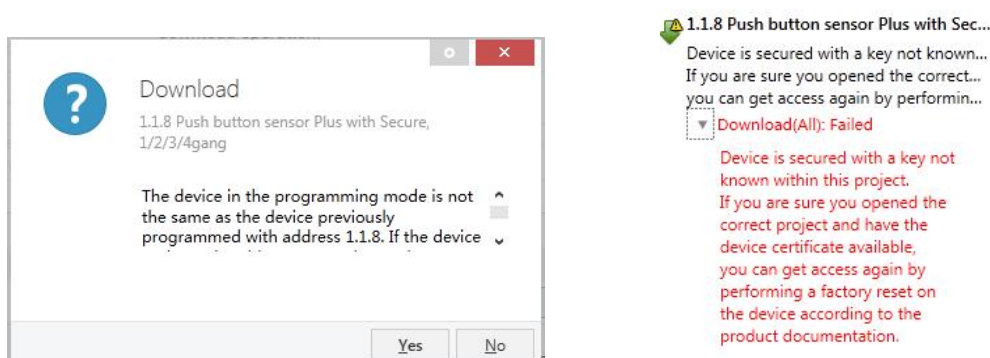

Fig.5.1(6) Example

Whether the device is replaced in the same project, or the device is replaced in a different project, the processing is similar: **Reset the device to the factory settings, then reassign the FDSK.**

After the device is downloaded successfully, the label Add Device Certificate turns gray, indicating that the key for this device has been assigned successfully, as shown in Fig.5.1(7) below.



Fig.5.1(7)

ETS generates and manages keys:

Keys and passwords can be exported as needed to the use of security keys outside of the associated ETS projects. As shown in Fig.5.1(8) below, the file extension is .knxkeys.

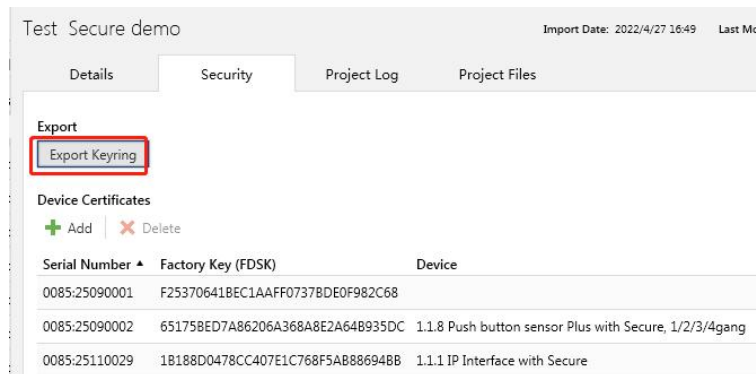

Fig.5.1(8)

**Note: Any USB interface used for programming a KNX Secure device must support “long frames”.**

**Otherwise ETS will report a download failure information, as shown below.**

## 5.2. Parameter window “General”

### 5.2.1. Parameter window “Setting page guideline”

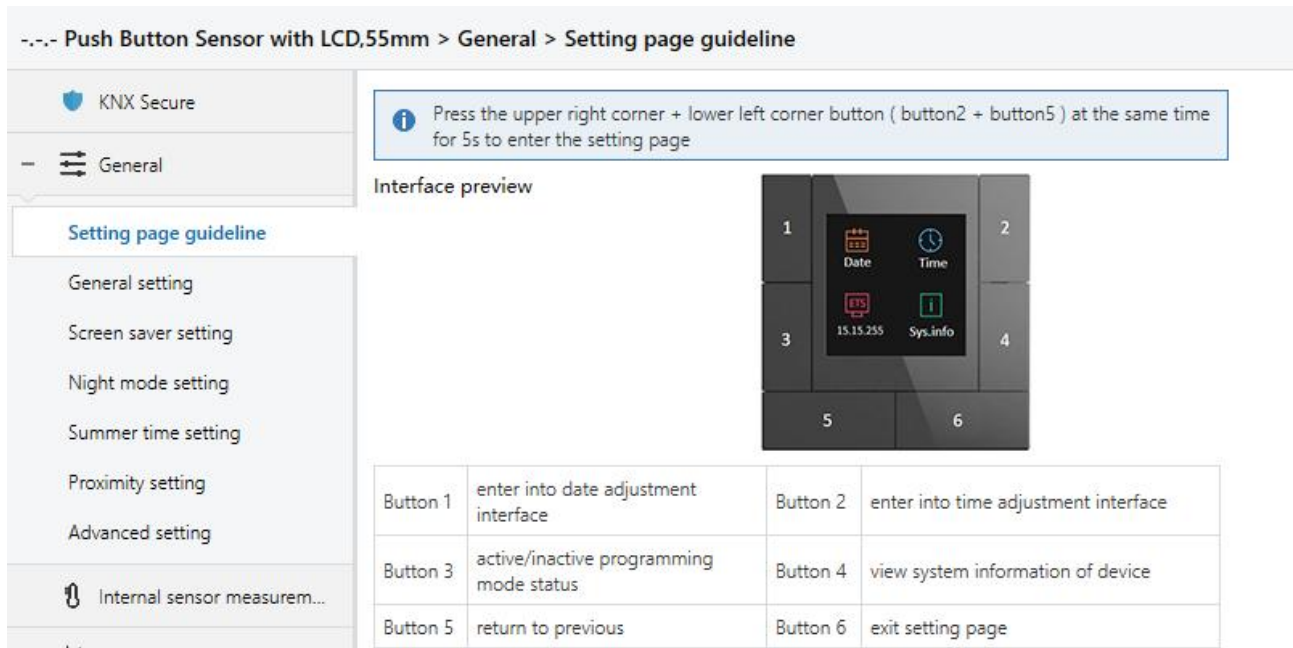

Fig.5.2.1 “KNX Secure” parameter window

This window displays the button operation of Setting page, specific UI please refer to chapter 7.5.

### 5.2.2. Parameter window “General setting”

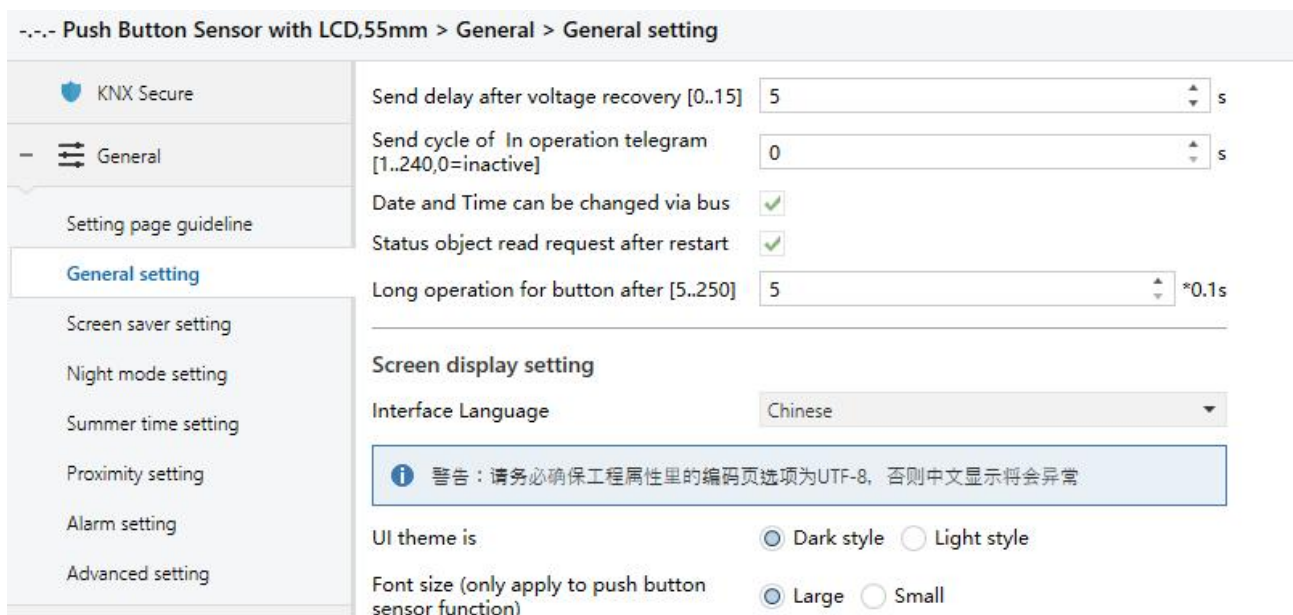

Fig.5.2.2(1) “General setting” parameter window



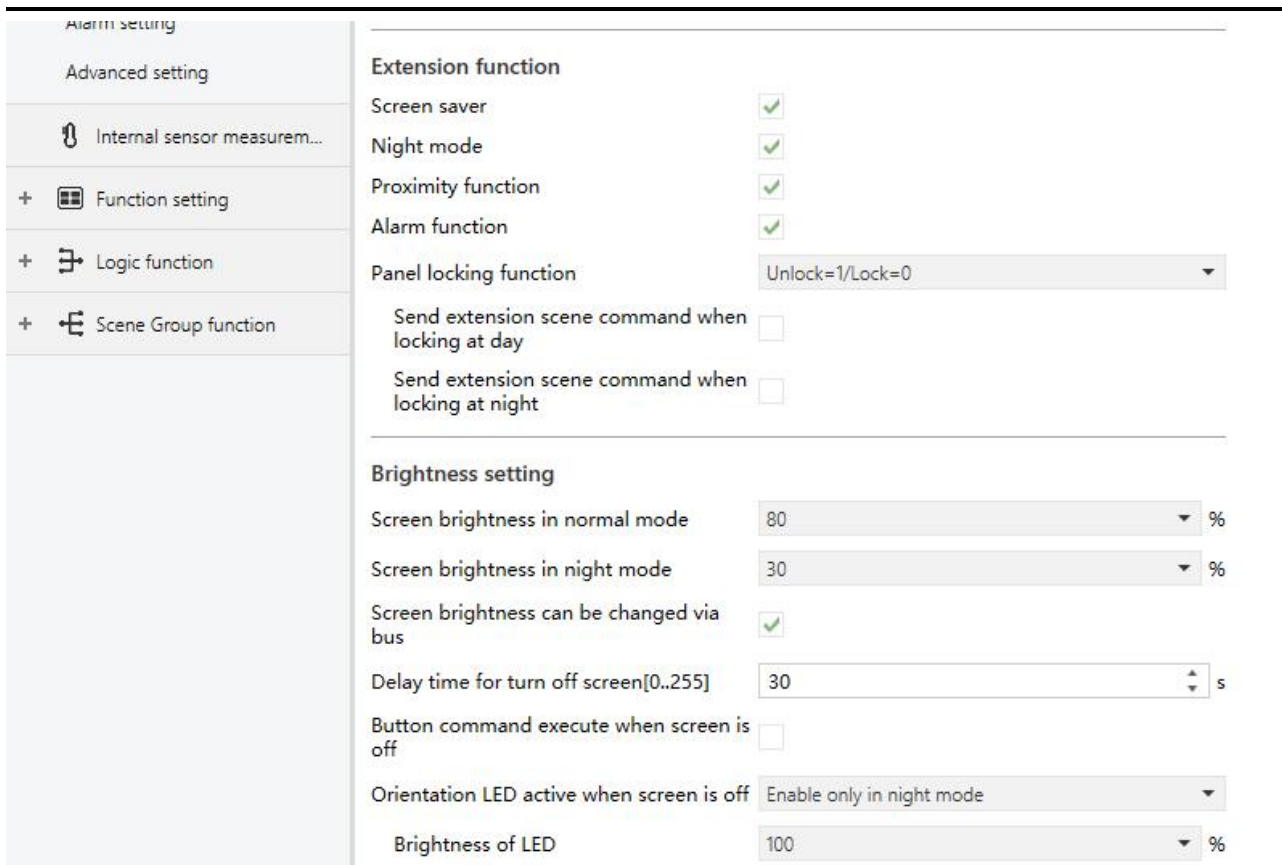

Fig.5.2.2(2) “General setting” parameter window

**Parameter “Send delay after voltage recovery [0..15]s”**

This parameter is for setting the delay time to send to bus after the device voltage recovery. Options: **0..15**

The setting dose not contain the device initialization time, and bus telegrams received during delay time will be recorded.

**Parameter “Send cycle of “In operation” telegram [1..240,0=inactive]s”**

This parameter is for setting the time interval when cyclically send telegrams through the bus to indicate this device in normal operation. When set to “0”, the object “In operation” will not send a telegram. If the setting is not “0”, the object “In operation” will send a telegram according to the setting period time with logic “1” to the bus. Options: **0..240s,0= inactive**

As to reduce the bus load as much as possible, the maximum time interval should be selected according to actual application requirement.

**Parameter “Date and Time can be changed via bus”**

This parameter is for setting whether the display of date/time on the interface can be modified by the bus.

If enabled, the object “Date” and the object “Time” are visible, date and time can be modified through the

two objects respectively.

**Note: The device accuracy of RTC real-time clock inside the equipment is  $\pm 10\text{ppm}$ .**

## Parameter "Status object read request after restart"

This parameter is for setting whether to send status read request telegram when the device starts up. The sending time interval is fixed to 100ms.

## Parameter "Long operation for button after [5...250]\*0.1s"

This parameter is for setting the valid time of long operation for button. Options: **5..250**

## Screen display setting

### Parameter "Interface Language"

This parameter is for setting the interface language of screen. Options:

**Chinese**

**English**

**German**

**i** Note: The codepage option in the property of project must select the Unicode(UTF-8)

**i** 警告：请务必确保工程属性里的编码页选项为UTF-8，否则中文显示将会异常

UTF-8 setting as shown as follow:

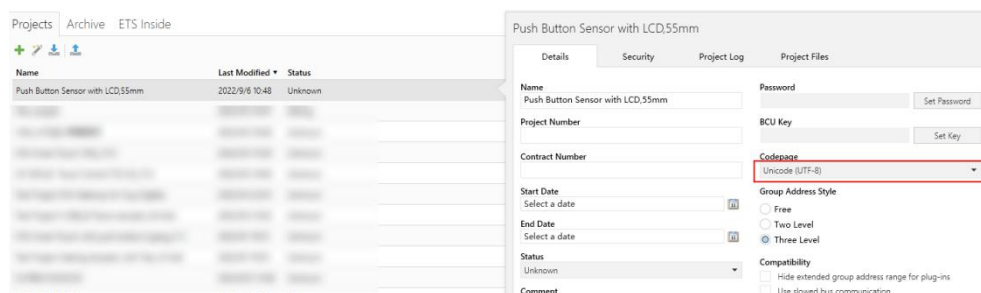

### Parameter "UI theme is"

This parameter is for setting the UI theme. Options:

**Dark style**

**Light style**

Dark style is close to dark gray, light style is close to white, specific effect please refer to UI description.

### Parameter "Font size (only apply to push button sensor function)"



This parameter is for setting the font size displayed on the screen, which is for describing the icon function.

The setting is only applied to Push button sensor. Options:

**Large**

**Small**

## Extension function

Parameter "Screen saver"

Setting interface of screen saver will be visible when the parameter enabled.

Parameter "Night mode"

Setting interface of night mode will be visible when the parameter enabled.

Parameter "Proximity function"

Setting interface of proximity function will be visible when the parameter enabled.

Parameter "Alarm function"

Setting interface of alarm function will be visible when the parameter enabled.

Parameter "Panel locking function"

This parameter is for setting whether to enable panel locking function. Options:

**Disable**

**Unlock=1/Lock=0**

**Unlock=0/Lock=1**

Parameter "Send extension scene command when locking"

Parameter "Send extension scene command when locking at day"

Parameter "Send extension scene command when locking at night"

This parameter is for setting whether to enable send extension scene command when locking, you can set the scene number and scene object when enabled. If night mode is enabled, the scene numbers at day/night can be configured independently.

When the panel is locking, operate any buttons to send the scene number.

—Parameter "Scene NO."

This parameter is visible when previous parameter is enabled. Set the sending scene number, corresponding

telegram is 0~63. Options:

**Scene NO.1**

**Scene NO.2**

**Scene NO.3**

...

**Scene NO.64**

## **Brightness setting**

### Parameter "Screen brightness in normal mode"

This parameter is for setting the screen brightness level when normal or day mode (some one proximity/operation). Options:

**20%**

...

**90%**

**100%**

User can change brightness via object "Screen brightness". Voltage failure or exit day mode, the new brightness value will also be stored.

### Parameter "Screen brightness in night mode"

This parameter is visible when night mode is enabled. Set the the screen brightness level when night mode (some one proximity/operation). Options:

**20%**

...

**90%**

**100%**

**Unchanged**

User can change brightness via object "Screen brightness". Voltage failure or exit night mode, the new brightness value will also be stored.

When "Unchanged" is selected, the brightness remains at the brightness of day mode, user can only change the brightness temporarily via the object. Voltage failure or exit night mode, the new brightness value will be not stored.

Parameter "Screen brightness can be changed via bus"

This parameter is for setting whether the screen brightness can be changed via bus.

If enabled, the object "Screen brightness" is visible. It is only used to change the brightness of current status.

E.g. if it is currently day mode, only the brightness settings in day mode are updated.

Brightness of screen saver can not be changed via the object.

Parameter "Delay time for turn off screen[0...255]s"

This parameter is for setting the delay time that off screen after no operation or enter screen saver.

Options: **0..255**

When the value is 0, there is a object "Screen on/off" for controlling on/off screen via bus.

Parameter "Button command execute when screen is off"

This parameter is for setting whether the button command is executed when screen is off.

Parameter "Orientation LED active when screen is off"

This parameter is for setting the orientation LED status when screen is off, which is used to indicate the location of device. Options:

**Disable**

**Enable only in night mode**

**Enable always**

When night mode is disabled, "Enable only in night mode" is not visible.

—Parameter "Brightness of LED"

This parameter is visible when "Enable only in night mode" or "Enable always" is selected. Set the brightness of orientation LED. Options:

**10%**

**20%**

**...**

**90%**

**100%**

**5.2.3. Parameter window “Screen saver setting”**

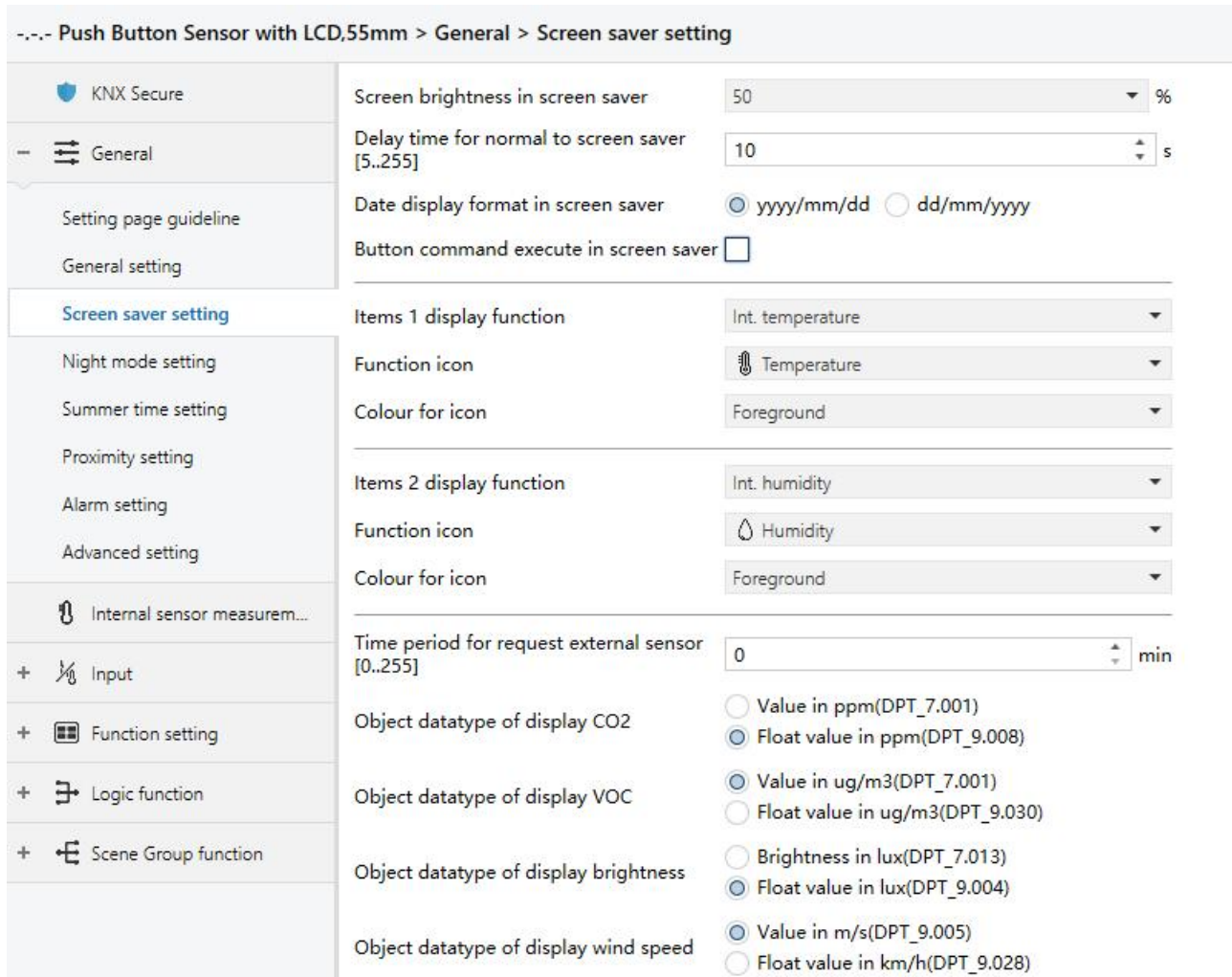

Fig.5.2.3 “Screen saver setting” parameter window

**Parameter “Screen brightness in screen saver”**

This parameter is for setting screen brightness level in screen saver. Options:

- 20%**
- 30%**
- 40%**
- 50%**

**Parameter “Delay time for normal to screen saver [5..255]s”**

This parameter is for setting the delay time for normal mode to screen saver. Options: **5..255**

**Parameter “Date display format in screen saver”**

This parameter is for setting the date display format in screen saver. Options:

- yyyy/mm/dd**

**dd/mm/yyyy**

yyyy: year; mm: month; dd: day.

**Parameter "Button command execute in screen saver"**

This parameter is for setting whether the button command is executed in screen saver.

**Parameter "Items x display function" (x=1-2)**

This parameter is for setting the air quality information displayed in screen saver, up to 2 items. Options:

<b>None</b>	<b>VOC</b>
<b>Int. temperature</b>	<b>CO2</b>
<b>Int. humidity</b>	<b>Brightness</b>
<b>Ext. temperature</b>	<b>Wind speed</b>
<b>Ext. humidity</b>	

Parameters as follow are not visible when "None" is selected.

**Parameter "Function icon"**

This parameter is for setting the icon for air quality information using. Options:

**Light on**  
**Light off**  
...  
**PM10**

The default icons corresponding to the function and the icons corresponding to the options are described in the appendix, please refer to chapter 8.1.

**Parameter "Colour for icon"**

This parameter is for setting the icon colour for air quality information using. Options:

<b>Foreground</b>	<b>Cyan blue</b>
<b>Red</b>	<b>Cyan</b>
<b>Dark green</b>	<b>Coffee</b>
<b>Blue</b>	<b>Light orange</b>
<b>Yellow</b>	<b>Customized colour 1</b>
<b>Orange</b>	<b>Customized colour 2</b>

<b>Purple</b>	<b>Customized colour 3</b>
<b>Grey</b>	<b>Customized colour 4</b>
<b>Pink</b>	<b>Customized colour 5</b>

Parameter "Time period for request external sensor [0..255]min"

This parameter is for setting the time period for device to send a control value read request to external sensor after bus recovery or finish programming. Not send when value is 0. Options: **0..255**

Parameter "Object datatype of display CO2"

This parameter is for setting the object datatype of display CO2. Options:

**Value in ppm(DPT\_7.001)**

**Float value in ppm(DPT\_9.008)**

Parameter "Object datatype of display VOC"

This parameter is for setting the object datatype of display VOC. Options:

**Value in ug/m3(DPT\_7.001)**

**Float value in ug/m3(DPT\_9.030)**

Parameter "Object datatype of display brightness"

This parameter is for setting the object datatype of display brightness. Options:

**Brightness in lux(DPT\_7.013)**

**Float value in lux(DPT\_9.004)**

Parameter "Object datatype of display wind speed"

This parameter is for setting the object datatype of display wind speed. Options:

**Value in m/s(DPT\_9.005)**

**Float value in km/h(DPT\_9.028)**

### 5.2.4. Parameter window “Night mode setting”

--- Push Button Sensor with LCD,55mm > General > Night mode setting

<ul style="list-style-type: none"> <li>KNX Secure</li> <li>General</li> <li>Setting page guideline</li> </ul>	Polarity of normal/night mode <input type="radio"/> Normal=1/Night=0 <input checked="" type="radio"/> Normal=0/Night=1 Switchover normal/night mode Via object Note: Default to normal mode if no response when request after startup
<ul style="list-style-type: none"> <li>KNX Secure</li> <li>General</li> <li>Setting page guideline</li> <li>General setting</li> <li>Screen saver setting</li> </ul>	Via object Polarity of normal/night mode <input type="radio"/> Normal=1/Night=0 <input checked="" type="radio"/> Normal=0/Night=1 Switchover normal/night mode Depend to certain time Note: Default to normal mode if no response when request after startup Time for switch to night at 18:00 hh:mm Time for switch to normal(day) at 06:00 hh:mm
<ul style="list-style-type: none"> <li>KNX Secure</li> <li>General</li> <li>Setting page guideline</li> <li>General setting</li> <li>Screen saver setting</li> <li><b>Night mode setting</b></li> <li>Summer time setting</li> <li>Proximity setting</li> <li>Alarm setting</li> <li>Advanced setting</li> <li>Internal sensor measurem...</li> <li>Input</li> <li>Function setting</li> <li>Logic function</li> <li>Scene Group function</li> </ul>	Depend to certain time Polarity of normal/night mode <input type="radio"/> Normal=1/Night=0 <input checked="" type="radio"/> Normal=0/Night=1 Switchover normal/night mode Depend to sunrise&sunset Note: Default to normal mode if no response when request after startup <b>Coordinates location setting</b> Latitude longitude setting location Beijing, China Latitude <input checked="" type="radio"/> North <input type="radio"/> South Latitude in degrees [0..90] 39 ° Latitude in minutes [0..59] 56 ' Longitude <input checked="" type="radio"/> East <input type="radio"/> West Longitude in degrees [0..180] 116 ° Longitude in minutes [0..59] 20 ' Time difference from Universal Time (UTC + ...) (UTC +08:00) Singapore, Beijing, Hong Kong, Taipei <b>Time calibration</b> Switching time move to night [-128..127] 0 min Switching time move to day [-128..127] 0 min Depend to sunrise&sunset

Fig.5.2.4 “Night mode setting” parameter window

#### Parameter “Polarity of normal/night mode”

This parameter for setting object value of normal/night mode. Options:

**Normal=1/Night=0**

**Normal=0/Night=1**

### Parameter “Switchover normal/night mode”

This parameter for setting the switchover way of normal/night status, send status telegrams via object “Night mode” when status change. Options:

**Via object**

**Depend to certain time**

**Depend to sunrise&sunset**

Via object: only switch status via object.

Depend to certain time: switch the normal/night status based on the specific time. Such as switch 18:30P.M. to the night status, 6:30A.M. to the normal status.

Depend to sunrise&sunset: switch the normal/night status based on the sunrise and sunset. The coordinate position of the reference point of sunrise and sunset, such as Beijing, China, needs to be defined, with the center located at east longitude 160°20'and north latitude 39°56'.

 Note: Default to normal mode if no response when request after startup

**Note: default to normal mode if no response when request after startup. That is, screen backlight and LED status indication are according to normal (day) mode to display.**

**When “Depend to certain time” is selected, the following 2 parameters are visible, for setting the time to switch to the night or to the normal.**

—Parameter “Time for switch to night at”

This parameter for setting the time point to switch to the night status, accurate to minutes.

Options: **00:00-23:59**

—Parameter “Time for switch to normal(day) at”

This parameter for setting the time point to switch to the normal status, accurate to minutes.

Options: **00:00-23:59**

**When “Depend to sunrise&sunset” is selected, the following parameters are visible, for setting the coordinate position of the reference point of sunrise and sunset.**



### **Coordinates location setting**

#### **—Parameter “Latitude longitude setting location”**

Setting the reference point of sunrise and sunset, such as “Beijing, China”.

#### **—Parameter “Latitude”**

Setting whether the reference point of sunrise and sunset is located at south latitude or north latitude.

Options:

**North**

**South**

#### **—Parameter “Latitude in degrees [0° ..90° ]”**

#### **—Parameter “Latitude in minutes [0'..59']”**

These two parameters for setting latitude, such as Beijing located at north latitude 39°56’.

#### **—Parameter “Longitude”**

Setting whether the base point of sunrise and sunset is located at east longitude or west longitude. Options:

**East**

**West**

#### **—Parameter “Longitude in degrees [0° ..180° ]”**

#### **—Parameter “Longitude in minutes [0'..59']”**

These two parameters for setting longitude, such as Beijing located at east longitude 116°20’.

#### **—Parameter “Time difference from Universal Time (UTC + ...)”**

This parameter for setting the time difference from Universal Time. Options:

**(UTC -12: 00) International Date Line West**

**(UTC -11: 00) Samoa**

.....

**(UTC +11: 00) Magadan, Salomon Islands, New Caledonia**

**(UTC +12: 00) Auckland, Wellington, Fiji**

### **Time calibration**

#### **—Parameter “Switching time move to night [-128..127]min”**

This parameter for setting the delay time to switch to the night status after reaching to the time point of sunset. Options: -128..127

—Parameter “Switching time move to day [-128..127]min”

This parameter for setting the delay time to switch to the day status after reaching to the time point of sunrise.

Options:-128..127

For example, if setting -10min, it will switch to day status 10min earlier before the sunrise; if setting 10min, it will switch to day status 10min later after the sunrise.

**Note: if summer time is set, then sunrise and sunset time will automatically adjust according to time interval of summer time. Details refer to section 5.2.5.**

**5.2.5.Parameter window “Summer time setting”**

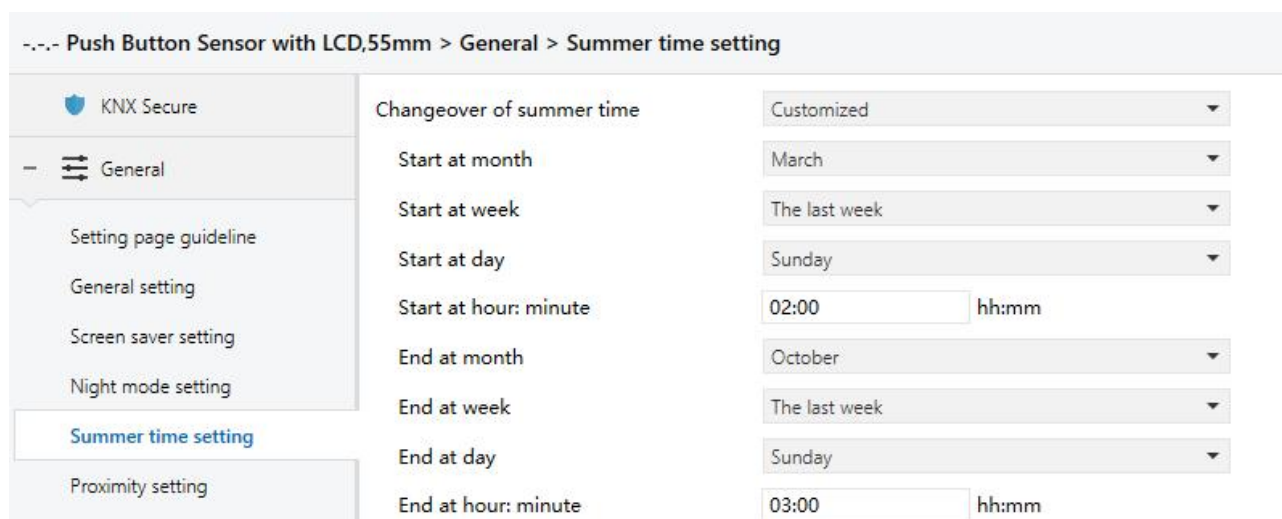

Fig.5.2.5 “Summer time setting” parameter window

**Parameter “Changeover of summer time”**

This parameter is for setting the summer time. Options:

**No active**

**Always**

**Customized**

No: disable summer time.

Always: always enable summer time.

Customized setting: for customized setting the start/end time of summer time.

When “Customized setting” is selected, the following four parameters are visible, for setting the start and end time of summer time.

—Parameter “Start at month”

—Parameter “End at month”

These parameters are for setting summer time start or end at month. Options:

**January**

**February**

...

**December**

—Parameter “Start at week”

—Parameter “End at week”

These parameters are for setting summer time start or end at week. Options:

**The first week**

**The second week**

...

**The last week**

—Parameter “Start at day”

—Parameter “End at day”

These parameters are for setting summer time start or end at day. Options:

**Monday**

**Tuesday**

...

**Sunday**

—Parameter “Start at hour: minute”

—Parameter “End at hour: minute”

These parameters are for setting summer time start or end time, accurate to minutes. Options: **00:00-23:59**

Take American time for example, setting summer time start from 02h: 00min, the second Sunday of March to 02h: 00min, the first Sunday of November each year, so during this summer time, when it comes to the start time,

system default time will be an hour faster, displayed time on the device will be 03h: 00min; when it comes to the end time, system default time will be an hour slower, displayed time on the device will be 02h:00min.

**Note: if the start and end parameters are set to the same month, week and day, the configuration will be ignored and recovered to default. If only the month and week are set to the same will also be ignored.**

### 5.2.6.Parameter window “Proximity setting”

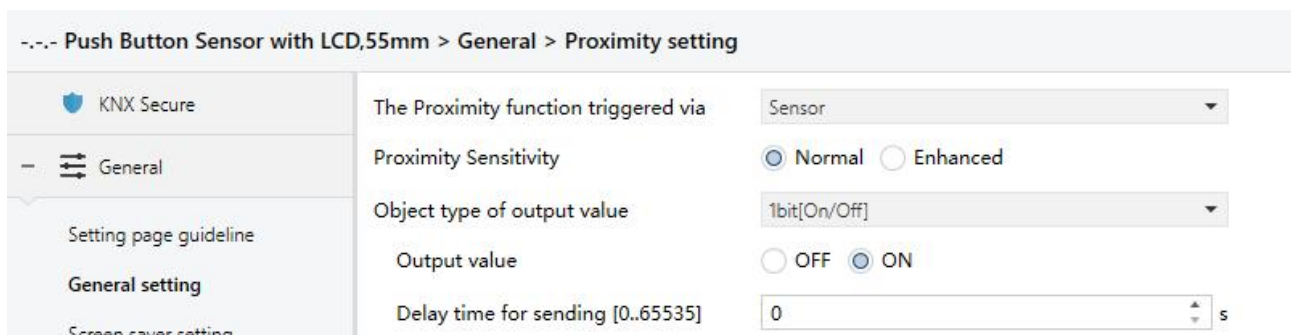

Fig.5.2.6 “Proximity setting” parameter window

#### Parameter “The Proximity function triggered via”

This parameter is for setting the trigger way of proximity function. Options:

- Sensor**
- Proximity object**
- Sensor or Proximity object**

When “Sensor or Proximity object” is selected, not send output value when proximity triggered via object.

Parameters as follow are visible when “Sensor” or “Sensor or Proximity object” is selected.

#### Parameter “Sensor sensitivity”

This parameter is for setting the sensor sensitivity. Options:

- Normal**
- Enhanced**

Normal is approximately 15cm, enhanced is approximately 30cm.

#### Parameter “Object type of output value”

This parameter is for setting the object type of output value sent to the bus when proximity is triggered.

Options:

- No reaction**

**1bit[On/Off]**

**1byte[scene control]**

**1byte[0..255]**

**1byte[0..100%]**

**2byte[0..65535]**

These two parameters are not visible when “No reaction” is selected.

—Parameter “Output value”

This parameter is for setting the output value sent to the bus when proximity approaching/leaving, the range of value is determined by the data type.

—Parameter “Delay time for sending [0..65535]s”

This parameter is for setting the delay time for sending telegram. Options: **0..65535**

**5.2.7.Parameter window “Alarm setting”**

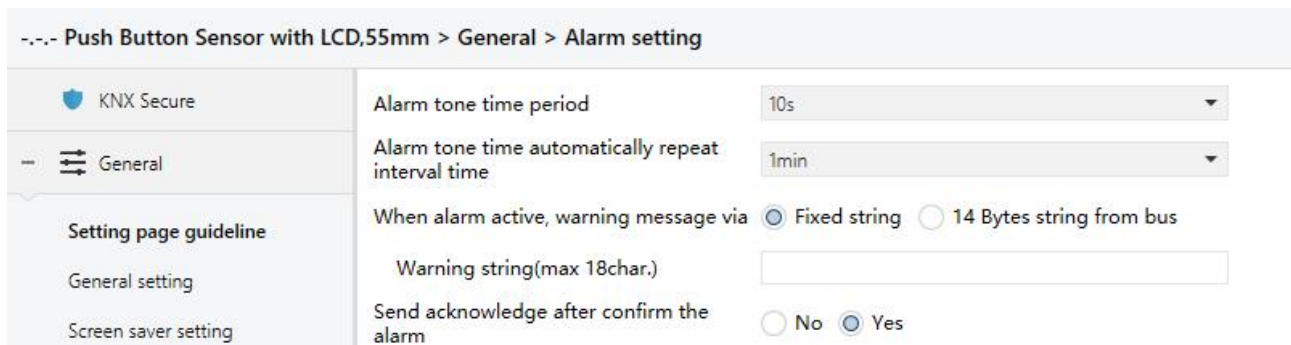

Fig.5.2.7 “Alarm setting” parameter window

**Parameter “Alarm tone time period”**

This parameter is for setting the time period of alarm tone. When receive the alarm telegram, play alarm tone immediately, if currently playing and it will not be interrupted and will not be re-timed. If receive the cancel alarm telegram when playing, it will be interrupted immediately. Options:

**Disable**

**10s**

**20s**

**...**

**25min**

**30min**

Disable: disable the alarm tone playing function;

Other options: the playing period of alarm tone.

Parameter "Alarm tone time automatically repeat interval time"

This parameter is visible when previous parameter is enabled. Set the interval at which alarm tone time automatically repeat, and the timing is only related to when the last play ended. Options:

**Disable**

**10s**

**20s**

...

**25min**

**30min**

Disable: disable the alarm tone repeat function;

Other options: when a playing period complete, it will automatically play again after a delay of the setting time.

Parameter "When alarm active, warning message via"

When alarm activated, this parameter is for setting input type of warning message, either by displaying a fixed string entered by ETS on the screen or by receiving a 14byte string from the bus. Options:

**Fixed string**

**14 Bytes string from bus**

When it is selected "14 Bytes string from bus", display the information as follow:

 The encode data of telegram must be UTF-8 or ASCII characters

 The encode data of telegram must be ISO8859 or ASCII characters

**The encode data of alarm telegram is associated with interface language, when it is selected Chinese, use UTF-8 or ASCII; while other languages, use ISO8859 or ASCII.**

Parameter "Warning string(max 18char)"

This parameter is visible when previous parameter is selected "Fixed string". Set the indicate text when alarm activated.

## Parameter “Send acknowledge after confirm the alarm”

This parameter is for setting whether to send a 1bit acknowledge telegram, the action that only needs to be processed when the user clicks on the screen to acknowledge the warning message.

### 5.2.8.Parameter window “Advanced setting”

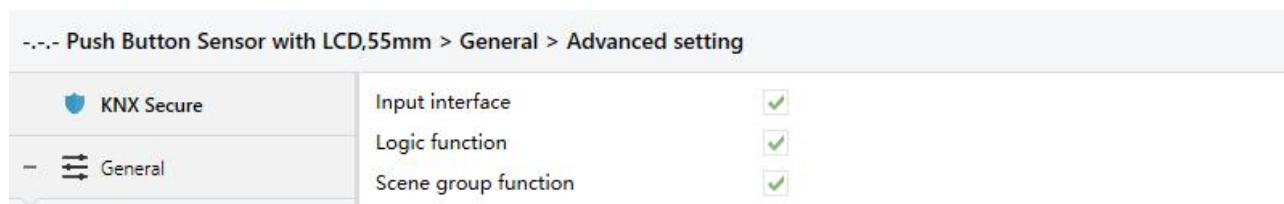

Fig.5.2.8 “Advanced setting” parameter window

## Parameter “Input interface”

Setting page of input interface is visible after this parameter enabled.

## Parameter “Logic function”

Setting page of logic function is visible after this parameter enabled.

## Parameter “Scene group function”

Setting page of scene group function is visible after this parameter enabled.

### 5.3. Parameter window “Internal sensor measurement”

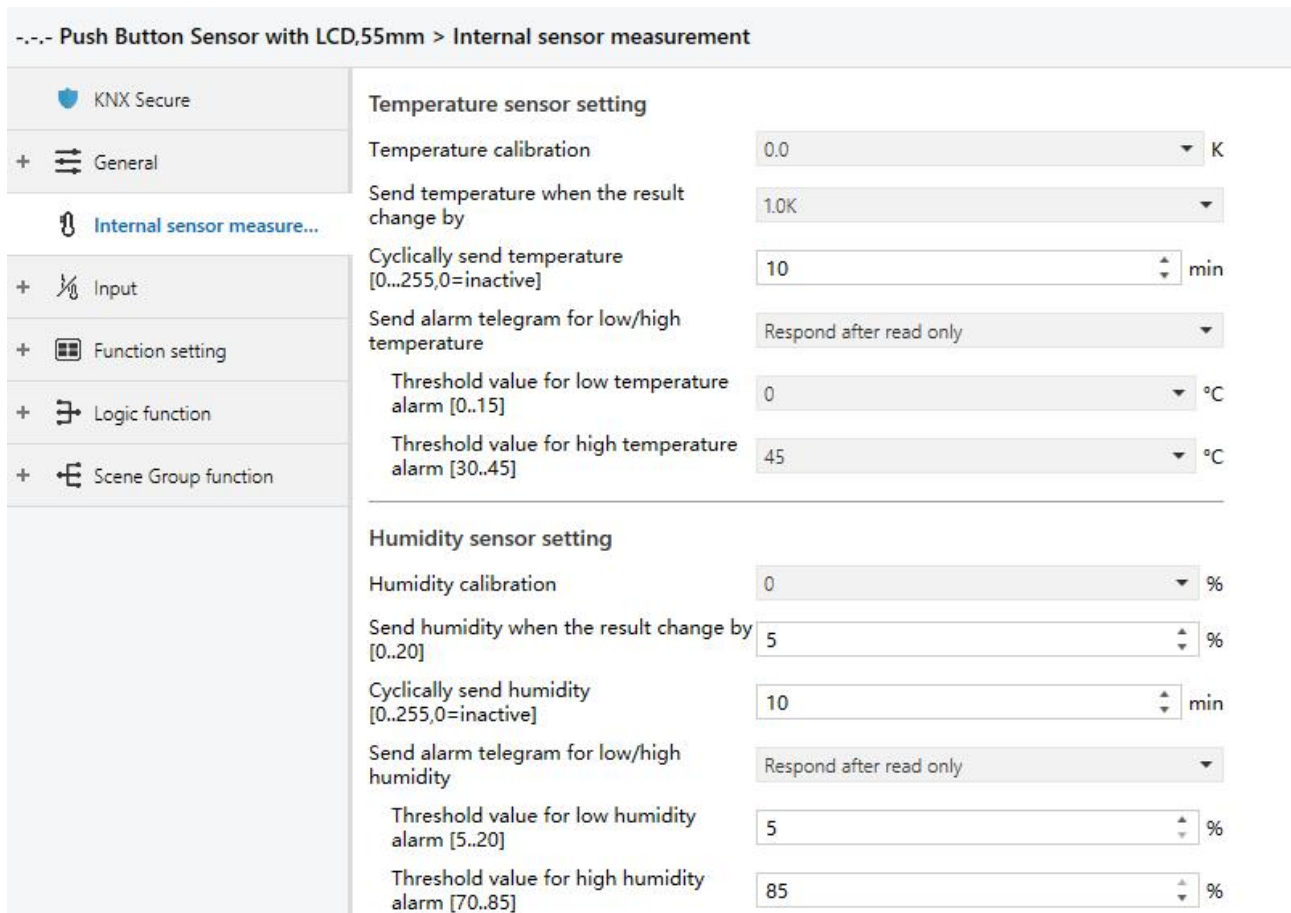

Fig.5.3 “Internal sensor measurement” parameter window

These parameters as follow are used for setting the calibration value, sending condition and error report of internal sensor, if other functions select to use internal sensor, refer to the settings here.

#### Temperature sensor setting

##### Parameter “Temperature calibration”

This parameter is for setting the temperature calibration value of the internal sensor, that is, to calibrate the measured value of internal sensor to make it closer to the current ambient temperature. Options:

- 5.0K
- ...
- 0.0K
- ...
- 5.0K

**Note:** after the device is powered on, the stability time of internal sensor detection will take 30 minutes, therefore, the detected temperature value in the early stage of device work may be inaccurate.



Parameter "Send temperature when the result change by"

This parameter is for setting when temperature turns to a certain value, whether to enable to send the current temperature value to the bus. Not send when disable. Options:

**Disable**

**0.5K**

**1.0K**

...

**10.0K**

Parameter "Cyclically send temperature [0...255.0--inactive]min"

Setting the time for cyclically sending the temperature detection value to the bus. Options: **0..255**

This period is independent and starts time counting after programming completion or reset. Transmission change has no affect on this period.

Parameter "Send alarm telegram for low/high temperature"

This parameter is for setting condition of sending telegram when low/high temperature alarm. Options:

**No respond**

**Respond after read only**

**Respond after change**

Respond after read only: only when the device receives a read alarm from other bus device or bus will the object "Low temperature alarm"/" High temperature alarm" send the alarm status to the bus;

Respond after change: the object "Low temperature alarm"/"High temperature alarm" will immediately send the telegram to the bus to report the alarm value when the alarm status has changed.

These two parameters as follow are visible when "Respond after read only" or "Respond after change" are selected.

—Parameter "Threshold value for low temperature alarm [0..15]° C"

This parameter is for setting the threshold value for low temperature alarm. When the temperature lower than low threshold, low temperature alarm object will send telegram. Options:

**0°C**

**1°C**

...

15°C

—Parameter “Threshold value for high temperature alarm [30..45] ° C”

This parameter is for setting the threshold value for high temperature alarm. When the temperature higher than high threshold, high temperature alarm object will send telegram. Options:

30°C

31°C

...

45°C

### Humidity sensor setting

Parameter “Humidity calibration”

This parameter is for setting the humidity calibration value of the internal sensor, that is, to calibrate the measured value of internal sensor to make it closer to the current ambient humidity.

Options: **-20% / -15% / -10% / -5% / -3% / -1% / 0% / 1% / 3% / 5% / 10% / 15% / 20%**

Parameter “Send humidity when the result change by [0..20] %”

This parameter is for setting when humidity turns to a certain value, whether to enable to send the current humidity value to the bus. Not send when value is 0. Options: **0..20**

Parameter “Cyclically send humidity [0..255.0=inactive] min”

Setting the time for cyclically sending the humidity detection value to the bus. Options: **0..255**

This period is independent and starts time counting after programming completion or reset. Transmission change has no affect on this period.

Parameter “Send alarm telegram for low/high humidity”

This parameter is for setting condition of sending telegram when low/high humidity alarm. Options:

**No respond**

**Respond after read only**

**Respond after change**

Respond after read only: only when the device receives a read alarm from other bus device or bus will the object “ Low humidity alarm”/“ High humidity alarm” send the alarm status to the bus;

Respond after change: the object “Low humidity alarm”/“High humidity alarm” will immediately send the telegram to the bus to report the alarm value when the alarm status has changed.

These two parameters as follow are visible when “Respond after read only” or “Respond after change” are selected.

— **Parameter “Threshold value for low humidity alarm [5..20]%**

This parameter is for setting the threshold value for low humidity alarm. When the humidity lower than low threshold, low humidity alarm object will send telegram. Options: **5..20**

— **Parameter “Threshold value for high humidity alarm [70..85]%**

This parameter is for setting the threshold value for high humidity alarm. When the humidity higher than high threshold, high humidity alarm object will send telegram. Options: **70..85**

## 5.4. Parameter window “Input”

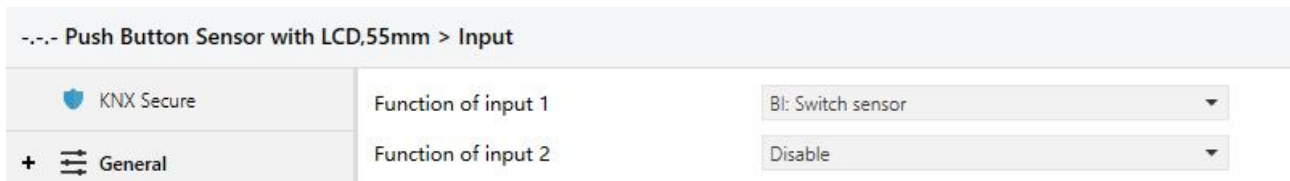

Fig.5.4 “Input” parameter window

### Parameter “Function of input x”(x=1, 2)

This parameter is for setting the function of external input interface. Support temperature detection and dry contact input (BI), setting page will be visible when select corresponding chosen. Also can be disable this channel function. Options:

**Disable**

**Temperature probe(NTC 10K)**

**BI: Switch sensor**

**BI: Scene control**

**BI: Send String(14bytes)**

When select Temperature probe(NTC 10K), can detect external temperature, which needs set B value of temperature probe.

When select dry contact input (BI), only supports the basic functions, including switch, scene send strings (press/release, short/long, send after voltage recovery, disable function).

Chapters as follow explain the functions of external input interface separately.

### 5.4.1. Temperature probe

--- Push Button Sensor with LCD,55mm > Input > Input 1 - Temperature probe

<ul style="list-style-type: none"> <li>KNX Secure</li> <li>+ General</li> <li>Internal sensor measurem...</li> <li>- Input</li> <li style="background-color: #e0e0e0;"><b>Input 1 - Temperature probe</b></li> <li>+ Function setting</li> <li>+ Logic function</li> <li>+ Scene Group function</li> </ul>	<p>Description (max 30char.)</p> <p>B value of temperature sensor (must refer to the characteristic of component)</p> <p>Temperature calibration</p> <p>Send temperature when the result change by</p> <p>Cyclically send temperature [0...255]</p> <p>Reply error of sensor measurement</p> <p>Object value of error</p> <p>Lower threshold value for error report</p> <p>Upper threshold value for error report</p>	<p><input type="text"/></p> <p>3950</p> <p>0.0 K</p> <p>1.0K</p> <p>0 min</p> <p>Respond after read only</p> <p><input checked="" type="radio"/> 0=no error/1=error <input type="radio"/> 1=no error/0=error</p> <p>0 °C</p> <p>60 °C</p>
--	---	---

Fig.5.4.1 Parameter setting of temperature probe

Parameter "Description (max 30char.)"

This parameter is for setting the name description of temperature probe.

Parameter "B value of temperature sensor(must refer to the characteristic of component)"

This parameter is for setting the B value of temperature sensor. Options:

- 3275
- 3380
- ...
- 4200

**Note: This value must refer to the characteristic of component, available from the instruction manual.**

**If selected B value is different from used sensor, it will effect detection result directly.**

Parameter "Temperature calibration"

This parameter is for setting the temperature calibration value of the temperature sensor, that is, to calibrate the measured value of sensor to make it closer to the current ambient temperature. Options:

- 5.0K
- ...
- 0.0K
- ...
- 5.0K

Parameter "Send temperature when the result change by"

This parameter is for setting when temperature turns to a certain value, whether to enable to send the current temperature value to the bus. Not send when disable. Options:

**Disable**

**0.5K**

**1.0K**

...

**10.0K**

Parameter "Cyclically send temperature [0...255,0=inactive]min"

Setting the time for cyclically sending the temperature detection value to the bus. Not send when value is 0.

Options: **0..255**

Parameter "Reply error of sensor measurement"

This parameter for setting the condition of sending error status report when temperature exceeds the valid detection. options:

**No respond**

**Respond after read only**

**Respond after change**

Respond after read only: only when the device receives a read error from other bus device or bus will the object "Temperature error report, Sensor" send the error status to the bus;

Respond after change: the object "Temperature error report, Sensor" will immediately send the telegram to the bus to report the error value when the error status has changed.

These three parameters as follow are visible when "Respond after read only" or "Respond after change" are selected.

—Parameter "Object value of error"

This parameter for defining object value of error. Options:

**0=no error/1=error**

**1=no error/0=error**

0=no error/1=error: the object value for which sensor no error occurs is 0, and the object value for which sensor error occurs is 1;

1=no error/0=error: it has the opposite meaning.

—Parameter “Upper threshold value for error report”

This parameter is for setting the upper threshold value for temperature error. When the temperature higher than the threshold, temperature error object will send telegram.

Options: 40°C / 45°C / 50°C / 55°C / 60°C / 70°C

—Parameter “Lower threshold value for error report”

This parameter is for setting the lower threshold value for temperature error. When the temperature lower than the threshold, temperature error object will send telegram.

Options: 10°C / 5°C / 0°C / -5°C / -10°C / -20°C

### 5.4.2.Binary input

--- Push Button Sensor with LCD,55mm > Input > Input 1 - Switch sensor

<ul style="list-style-type: none"> <li>KNX Secure</li> <li>General</li> <li>Internal sensor measurem...</li> <li>Input</li> <li><b>Input 1 - Switch sensor</b></li> <li>Function setting</li> <li>Logic function</li> </ul>	Description (max 30char.) Distinction between short and long operation Long operation after [3..25] Connected contact type Reaction on short operation Reaction on long operation Number of objects Disable function	<input type="text"/> <input type="radio"/> No <input checked="" type="radio"/> Yes 5 *0.1s <input checked="" type="radio"/> Normally open <input type="radio"/> Normally closed TOGGLE OFF <input checked="" type="radio"/> 1 <input type="radio"/> 2 Disable
---	---	--

Fig.5.4.2(1) Parameter setting of switch sensor

--- Push Button Sensor with LCD,55mm > Input > Input 1 - Scene control

<ul style="list-style-type: none"> <li>KNX Secure</li> <li>General</li> <li>Internal sensor measurem...</li> <li>Input</li> <li><b>Input 1 - Scene control</b></li> <li>Function setting</li> <li>Logic function</li> <li>Scene Group function</li> </ul>	Description (max 30char.) Distinction between short and long operation Long operation after [3..25] Connected contact type Reaction on short operation 8 bit scene number Reaction on long operation 8 bit scene number Number of objects Disable function	<input type="text"/> <input type="radio"/> No <input checked="" type="radio"/> Yes 5 *0.1s <input checked="" type="radio"/> Normally open <input type="radio"/> Normally closed Recall scene Scene No.2 Store scene Scene No.2 <input checked="" type="radio"/> 1 <input type="radio"/> 2 Disable
---	---	--

Fig.5.4.2(2) Parameter setting of scene control

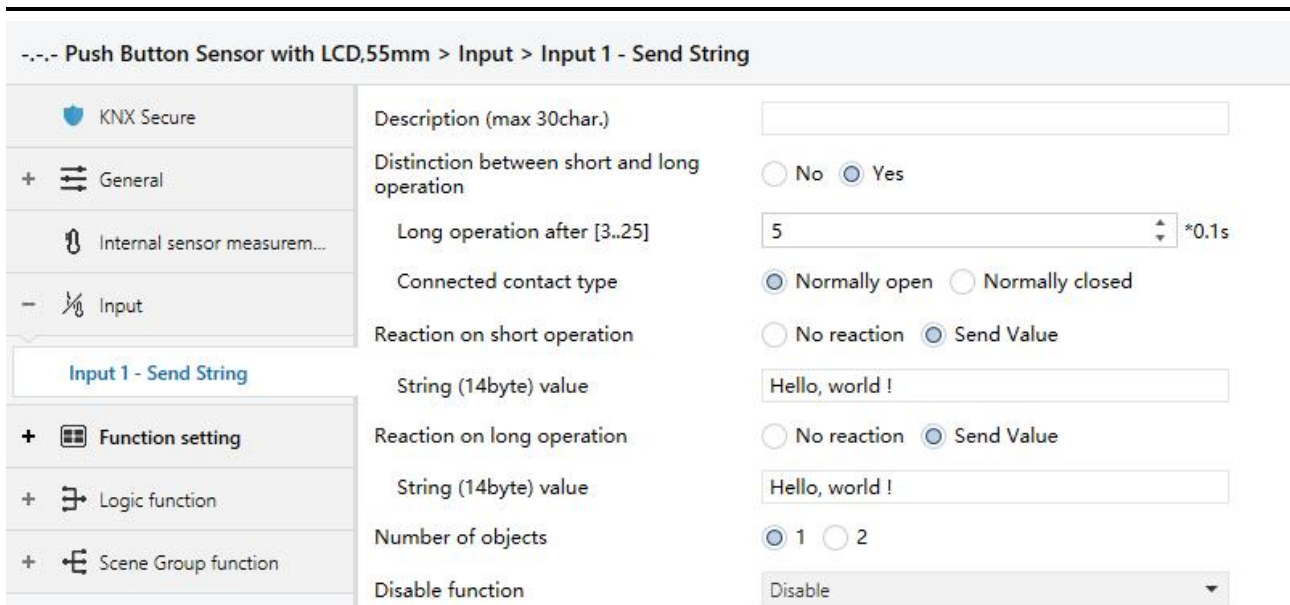

Fig.5.4.2(3) Parameter setting of sending sting

**Parameter “Description (max 30char.)”**

This parameter is for setting the name description for binary input function.

**Parameter “Distinction between short and long operation”**

This parameter is for setting whether to distinction between short and long operation. Options:

**No**

**Yes**

**—Parameter “Long operation after [3..25]\*0.1s”**

This parameter is visible when distinction between short and long operation. Set the effective time of long operation. When button operation out of the setting time, it is a long operation, otherwise it is a short operation.

Options: **3..25**

**—Parameter “Connected contact type”**

This parameter is visible when distinction between short and long operation. Set the connected contact type.

Options:

**Normally open**

**Normally closed**



When function is selected “BI: Switch sensor”, the following parameters are visible, for setting switch sensor.

—Parameter “Reaction on short/long operation”

This parameter is visible when distinction between short and long operation, performing the action according to the settings of the short and long operations. Set the switch value to send when button operation. Options:

**No reaction**

**OFF**

**ON**

**TOGGLE**

No action: No telegrams have been sent.

ON: Send the on telegram.

OFF: Send the off telegram.

TOGGLE: Each operation will switch between on and off.

—Parameter “Reaction on close/open the contact”

This parameter is visible when no distinction between short and long operation. Judge the close and open operations, and perform the actions according to the settings. Set the switch value to send when button operation. Options:

**No reaction**

**OFF**

**ON**

**TOGGLE**

—Parameter “Send object value after voltage recovery (valid if reaction is not toggle)”

This parameter is visible when no distinction between short and long operation. This parameter is valid if not select “TOGGLE” or “No reaction”, set whether to send object value after voltage recovery. Options:

**No**

**Yes**

When function is selected “BI: Scene control”, the following parameters are visible, for setting scene control.

—Parameter “Reaction on short/long operation”

This parameter is visible when distinction between short and long operation, performing the action according to the settings of the short and long operations. Set the scene command to send when button operation. Options:

**No reaction**

**Recall scene**

**Store scene**

—Parameter “Reaction on close/open the contact”

This parameter is visible when no distinction between short and long operation. Judge the close and open operations, and send or storage scenes according to the settings. Set the scene command to send when button operation. Options:

**No reaction**

**Recall scene**

**Store scene**

—Parameter “8 bit scene number”

This parameter is visible when “Recall scene” or “Store scene” is selected. Set the scene number, range: **Scene NO.1~64, corresponding telegram is 0~63**

When function is selected “BI: Send String(14bytes)”, the following parameters are visible, for setting string sending.

—Parameter “Reaction on short/long operation”

This parameter is visible when distinction between short and long operation, performing the action according to the settings of the short and long operations. Options:

**No reaction**

**Send Value**

—Parameter “Reaction on close/open the contact”

This parameter is visible when no distinction between short and long operation. Judge the close and open

operations, and send strings according to the settings. Options:

**No reaction**

**Send Value**

—Parameter “String (14byte) value”

This parameter is visible when “Send Value” is selected. Input the strings to send.

—Parameter “Send object value after voltage recovery”

This parameter is visible when no distinction between short and long operation. Set whether to send object value after voltage recovery. Options:

**No**

**Yes**

## Parameter “Number of objects”

This parameter is visible when the parameter “Reaction on long/open operation” is not selected “No reaction”. Set whether to use a common object or two separate objects when open/close and long/short operations.

Options:

**1**

**2**

## Parameter “Disable function”

This parameter is visible when binary input functions are selected. Set trigger value to disable/enable contacts. Options:

**Disable**

**Disable=1/Enable=0**

**Disable=0/Enable=1**

## 5.5. Parameter window “Function setting”

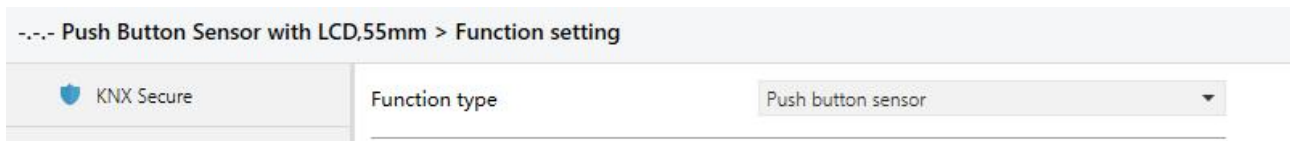

Fig.5.5 “Function setting” parameter window

### Parameter “Function type”

This parameter is for setting the function type of device. Options:

**Push button sensor**

**Multifunction thermostat**

**Audio control**

Chapters as follow explain the above functions separately.

**5.5.1. Parameter window “Push button sensor”**

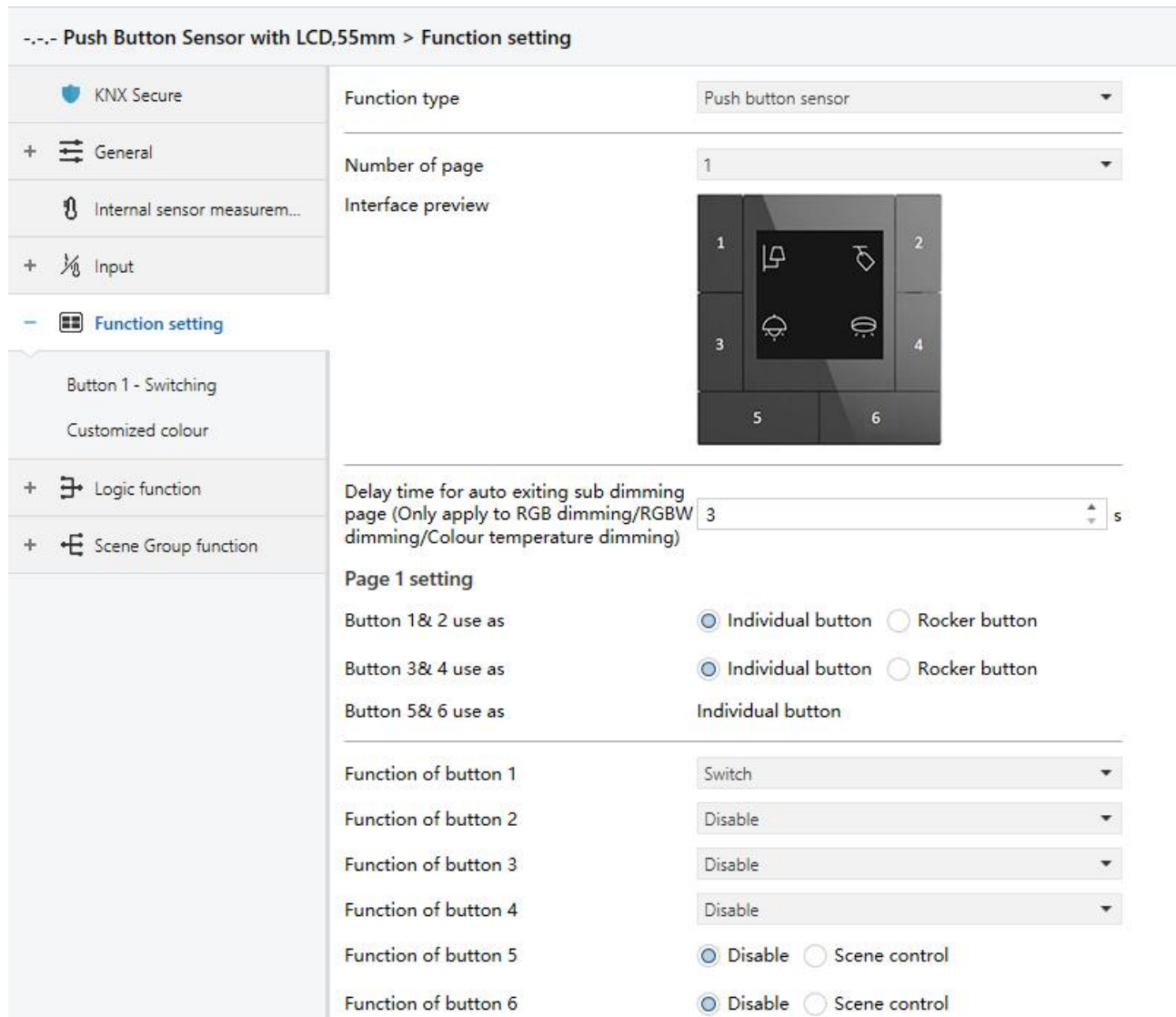

Fig.5.5 “Function setting”-“Push button sensor” parameter window

**Parameter “Number of page”**

This parameter is for setting number of page for push button sensor. Options: **1 / 2 / 3**

You can set 1 page with 4 buttons, 2 pages with 8 buttons, or 3 pages with 12 buttons.

When 1 page is selected, the 2 buttons on the bottom of the device (Button 5 and Button 6) only support the scene function, and can only be configured as individual buttons and have no status display.

When 2 pages or 3 pages is selected, the 2 buttons on the bottom of the device (Button 5 and Button 6) are used to switch function pages.

Below the parameter, display the interface interview according to the options.

Parameter “Delay time for auto exiting sub dimming page

(Only apply to RGB dimming/RGBW dimming/Colour temperature dimming)”

This parameter is for setting the delay time for auto exiting sub dimming page, only apply to RGB dimming, RGBW dimming, Colour temperature dimming. Telegrams are sent immediately, such as brightness, colour temperature, specific definition is according to the UI. Options: **3..10s**

### Page x setting (x=1~3)

Parameter “Button y& z use as” (y=1/3/5/7/9/11; z=2/4/6/8/10/12)

This parameter is displayed according to the number of page. Set the work way of push button sensor.

Options:

**Individual button**

**Rocker button**

Parameter “Function of button x” (x=1~12)

This parameter is visible when “Individual button” is selected. Set the function of individual button, up to 12 buttons. Options:

<b>Disable</b>	<b>Shift register</b>
<b>Switch</b>	<b>Multiple operation</b>
<b>Dimming</b>	<b>Delay mode</b>
<b>RGB switching/send value</b>	<b>RTC operation mode</b>
<b>RGBW switching/send value</b>	<b>String(14bytes)</b>
<b>Colour temperature switching/send value</b>	<b>Status display</b>
<b>Value sender</b>	<b>RGB dimming</b>
<b>Scene control</b>	<b>RGBW dimming</b>
<b>Blind</b>	<b>Colour temperature dimming</b>

When 1 page is selected, the 2 buttons on the bottom of the device (Button 5 and Button 6) only support the scene function.

The detail configuration of individual button please refer to chapter 5.5.1.1 and chapter 5.5.1.2.

Parameter “Function of rocker x” (x=1-6)

This parameter is visible when “Rocker button” is selected. Set the function of rocker button, up to 6 buttons.

Options:

- |                |                            |
|----------------|----------------------------|
| <b>Disable</b> | <b>Scene control</b>       |
| <b>Switch</b>  | <b>Blind</b>               |
| <b>Dimming</b> | <b>Setpoint adjustment</b> |

The detail configuration of rocker button please refer to chapter 5.5.1.3 and chapter 5.5.1.4.

**5.5.1.1.Individual button**

**1.Switch function**

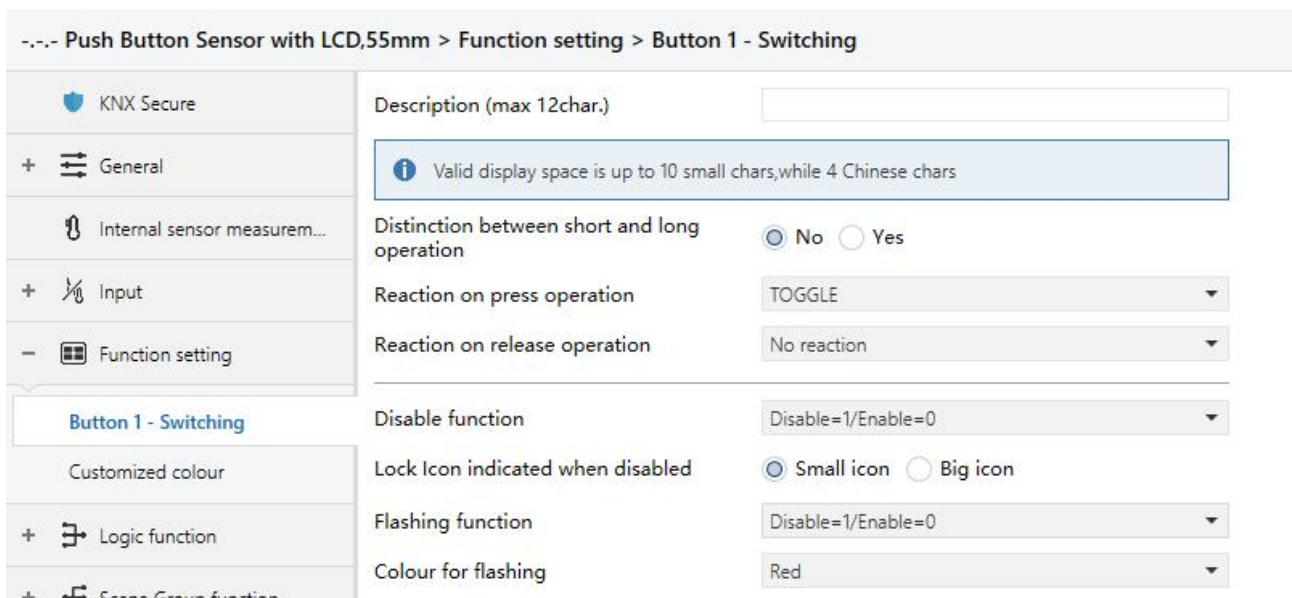

Fig.5.5.1.1(1) Parameter setting of switch function

Parameter “Description (max 12char.)”

This parameter is for setting the description of individual button, up to input 12 characters.



Parameter “Distinction between short and long operation”

This parameter is for setting whether to distinction the contact operation between short and long operation.

Options:

- No**

## Yes

When select “Yes”, the operation reaches a certain time to determine whether the operation is a long or short operation before the contact performs the setting action.

Parameter “Reaction on short/press operation”

Parameter “Reaction on long/release operation”

These parameters are for setting the performed actions when press/release the contact or long/short operation.

The object value is updated when the input is determined. Options:

**No reaction**

**OFF**

**ON**

**TOGGLE**

No action: no telegrams have been sent.

ON: send the on telegram.

OFF: send the off telegram.

TOGGLE: each operation will switch between on and off. For example, if the last telegram was sent (or received) for on, then the next operation will trigger a telegram for off. When the switch is operated again, it will send a telegram for on etc., So the switch will always remember the previous state and covert to opposite value during next operation.

Parameter “Number of objects”

This parameter is visible when the parameter “Reaction on long/release operation” is not selected “No reaction”. Set the number of objects when short/long or press/release operation:

**1**

**2**

Parameter “Disable function”

This parameter is for setting trigger value to disable/enable contacts. Options:

**Disable**

**Disable=1/Enable=0**

**Disable=0/Enable=1**

Parameter “Lock Icon indicated when disabled”



This parameter is visible when previous parameter is selected “Disable=1/Enable=0” or “Disable=0/Enable=1”. Set the icon size when the button is in disable status. Options:

**Small icon**

**Big icon**

Big icon is the lock icon replaces the original icon, while small icon is the two icons coexist and the lock icon is a small icon in right corner.

Specific effect please refer to UI description.

**Note: disable function is applied to each of following functions except for “Status display”.**

Parameter “Flashing function”

This parameter is for setting whether to enable flashing function. Options:

**Disable**

**Disable=1/Enable=0**

**Disable=0/Enable=1**

Parameter “Colour for flashing”

This parameter is visible when previous parameter is selected “Disable=1/Enable=0” or “Disable=0/Enable=1”. Set the colour for flashing. Options:

<b>Foreground</b>	<b>Cyan blue</b>
<b>Red</b>	<b>Cyan</b>
<b>Dark green</b>	<b>Coffee</b>
<b>Blue</b>	<b>Light orange</b>
<b>Yellow</b>	<b>Customized colour 1</b>
<b>Orange</b>	<b>Customized colour 2</b>
<b>Purple</b>	<b>Customized colour 3</b>
<b>Grey</b>	<b>Customized colour 4</b>
<b>Pink</b>	<b>Customized colour 5</b>

**Note: flashing function is only used for “Switch”, “Dimming” and “Blind”.**

**The flashing function takes precedence over normal status indications, and return to normal indication when cancel flashing. Specific flashing effect please refer to Chapter 7.1.**

Repeat parameters will not be illustrated below; the usage is similar.

## 2. Dimming function

--- Push Button Sensor with LCD,55mm > Function setting > Button 1 - Dimming

<ul style="list-style-type: none"> <li>KNX Secure</li> <li>+ General</li> <li>Internal sensor measurem...</li> <li>+ Input</li> <li>- Function setting</li> <li style="background-color: #e0e0e0;">Button 1 - Dimming</li> <li>Customized colour</li> </ul>	<p>Description (max 12char.) <input type="text"/></p> <p><b>i</b> Valid display space is up to 10 small chars,while 4 Chinese chars</p> <p>Reaction on short operation <span style="float: right;">TOGGLE ▼</span></p> <p>Reaction on long operation <span style="float: right;">Brighter/Darker ▼</span></p> <p>Dimming mode <span style="float: right;"><input checked="" type="radio"/> Start-Stop dimming <input type="radio"/> Step dimming</span></p> <hr/> <p>Disable function <span style="float: right;">Disable ▼</span></p> <p>Flashing function <span style="float: right;">Disable ▼</span></p>
---	--

Fig.5.5.1.1(2) Parameter setting of dimming function

### Parameter "Reaction on short operation"

This parameter is for setting the the switch value to send when short operation. Options:

**No reaction**

**OFF**

**ON**

**TOGGLE**

No action: no telegrams have been sent.

ON: send the on telegram.

OFF: send the off telegram.

TOGGLE: each operation will switch between on and off.

### Parameter "Reaction on long operation"

This parameter is for setting the the relative dimming value to send when long operation, with dimming brighter or darker; when release the contact stop dimming. Options:

**No reaction**

**Brighter**

**Darker**

**Brighter/Darker**

No action: no telegrams have been sent.

Brighter: the dimming up value will be sent.

Darker: the dimming down value will be sent.

Brighter/Darker: dimming up and down will be sent alternately.

**Note: in “TOGGLE” mode of this parameter setting, the value sent will be linked. For example, if the last value is switching on status, then it will be dimmed down in next dimming operation; if the last value is switching off, then it will be dimmed up in next dimming operation.**

#### Parameter “Dimming mode”

This parameter is visible when previous parameter is not “No reaction”. Set the way of relative dimming.

Options:

##### **Start-Stop dimming**

##### **Step dimming**

Start-stop dimming: the dimming mode will be start-stop, a dimming up or down telegram will be sent when the dimming starts, and a stop telegram will be sent when dimming ends. Here the dimming telegram will not be sent cyclically.

Steps dimming: the dimming mode will be a step one and the dimming telegram will be sent cyclically. When dimming ends, a stop dimming telegram will be sent immediately.

##### **—Parameter “ Step size”**

This parameter is visible when the dimming way is selected “Step dimming”. Set a cyclically sending dimming telegram which changes the brightness percentage, Options:

**100%**

**50%**

**...**

**1.56%**

##### **—Parameter “ Interval of tele. cyclic send [0..25,0=send once]\*0.1s”**

This parameter is visible when the dimming way is selected “Step dimming”. Set intervals of telegrams cyclically sending dimming telegram. Options: **0..25, 0=send once**

### 3.RGB switching/send value

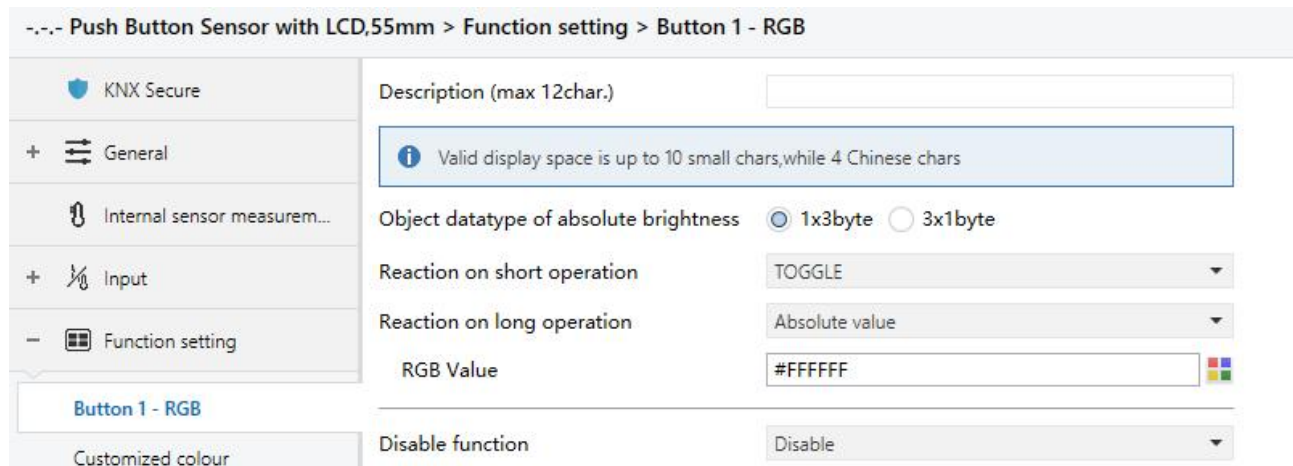

Fig.5.5.1.1(3) Parameter setting of RGB switching/send value

#### Parameter “Object datatype of absolute brightness”

This parameter is for setting the object datatype of absolute brightness. Options:

**1x3byte**

**3x1byte**

#### Parameter “Reaction on short operation”

#### Parameter “Reaction on long operation”

These two parameters are for setting the sending value when long/short operation. Options:

**No reaction**

**OFF**

**ON**

**TOGGLE**

**Absolute value**

Parameter as follow is visible when “Absolute value” is selected.

#### —Parameter “RGB Value”

This parameter is for setting the RGB value when long/short operation. Options: **#000000..#FFFFFF**

#### 4.RGBW switching/send value

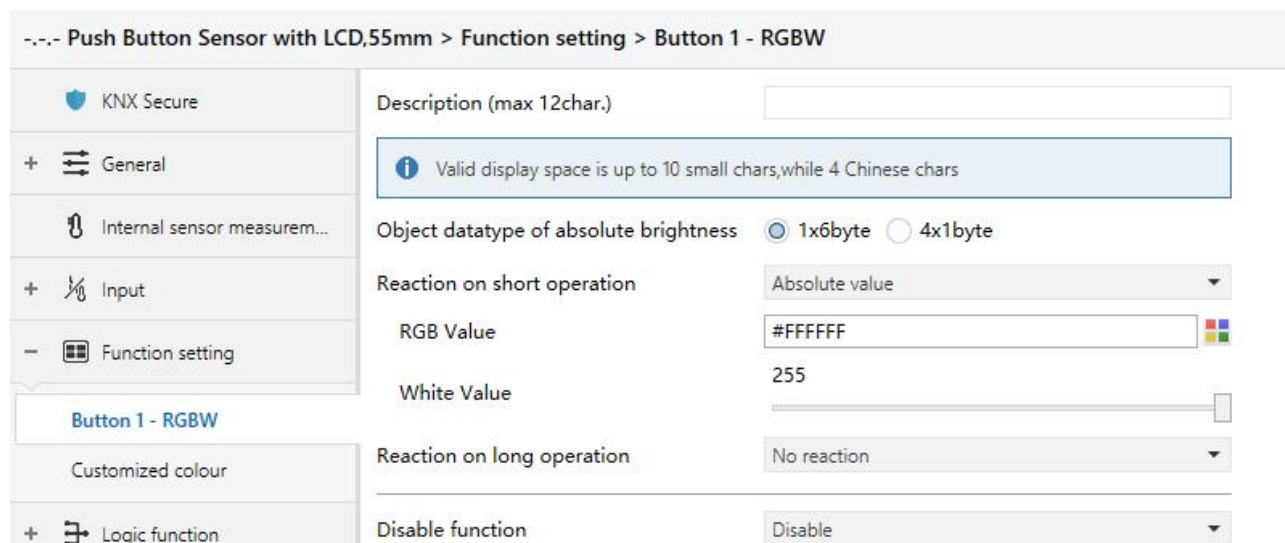

Fig.5.5.1.1(4) Parameter setting of RGBW switching/send value

#### Parameter “Object datatype of absolute brightness”

This parameter is for setting the object datatype of absolute brightness. Options:

**1x6byte**

**4x1byte**

#### Parameter “Reaction on short operation”

#### Parameter “Reaction on long operation”

These two parameters are for setting the sending value when long/short operation. Options:

**No reaction**

**OFF**

**ON**

**TOGGLE**

**Absolute value**

Parameters as follow are visible when “Absolute value” is selected.

#### —Parameter “RGB Value”

This parameter is for setting the RGB value when long/short operation. Options: **#000000..#FFFFFF**

#### —Parameter “White Value”

This parameter is for setting the white value when long/short operation. Options: **0..255**

## 5.Colour temperature switching/send value

--- Push Button Sensor with LCD,55mm > Function setting > Button 1 - Colour temperature

<ul style="list-style-type: none"> <li>KNX Secure</li> <li>+ General</li> <li>Internal sensor measurem...</li> <li>+ Input</li> <li>- Function setting</li> <li><b>Button 1 - Colour temperature</b></li> <li>Customized colour</li> </ul>	<p>Description (max 12char.) <input type="text"/></p> <p><b>i</b> Valid display space is up to 10 small chars,while 4 Chinese chars</p> <p>Reaction on short operation <span style="float: right;">Absolute value ▼</span></p> <p>Send brightness value <span style="float: right;">100 ▼ %</span></p> <p>Send Colour temperature value <span style="float: right;">4000 ▼ K</span></p> <p>Reaction on long operation <span style="float: right;">No reaction ▼</span></p> <hr/> <p>Disable function <span style="float: right;">Disable ▼</span></p>
--	---

Fig.5.5.1.1(5) Parameter setting of colour temperature switching/send value

Parameter “Reaction on short operation”

Parameter “Reaction on long operation”

These two parameters are for setting the sending value when long/short operation. Options:

**No reaction**

**OFF**

**ON**

**TOGGLE**

**Absolute value**

Parameters as follow are visible when “Absolute value” is selected.

—Parameter “Send brightness value”

This parameter is for setting the brightness value when long/short operation. Options: **0..100**

—Parameter “Send Colour temperature value”

This parameter is for setting the colour temperature value when long/short operation. Options: **1000..10000**

## 6.Value sender

--- Push Button Sensor with LCD,55mm > Function setting > Button 1 - Value sender

KNX Secure

+  General

Internal sensor measurem...

+  Input

-  Function setting

Button 1 - Value sender

Description (max 12char.)

i Valid display space is up to 10 small chars,while 4 Chinese chars

Reaction on short operation 1bit value[ON/OFF] ▼

Value 1  OFF  ON

Reaction on long operation No reaction ▼

---

Disable function Disable ▼

Fig.5.5.1.1(6) Parameter setting of value sender

Parameter “Reaction on short operation”

Parameter “Reaction on long operation”

These two parameters are for setting the datatype to send when long/short operation. Options:

<b>No reaction</b>	<b>2byte value[0..65535]</b>
<b>1bit value[On/Off]</b>	<b>2byte float value</b>
<b>2bit value[0..3]</b>	<b>4byte value[0..4294967295]</b>
<b>4bit value[0..15]</b>	<b>4byte float value</b>
<b>1byte value[0..255]</b>	

Parameters as follow are visible when “No reaction” is not selected.

### —Parameter “Value 1/2”

This parameter is for setting the data value to send when perform short/long operation. Range of value is determined according to the previous parameter selected datatype.

## 7.Scene control

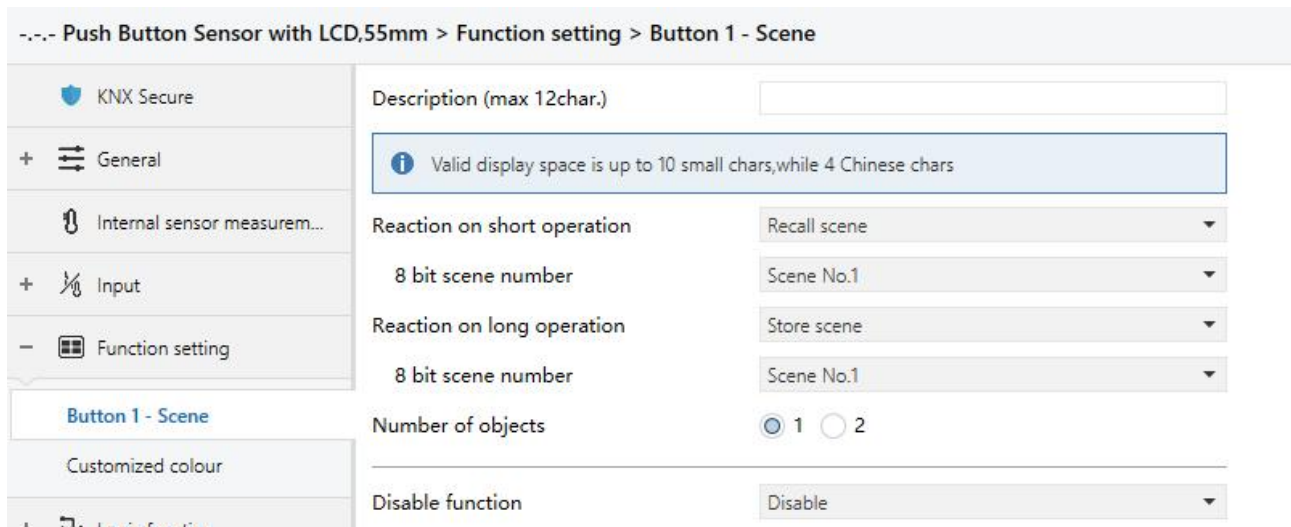

Fig.5.5.1.1(7) Parameter setting of scene control

Parameter “Reaction on short operation”

Parameter “Reaction on long operation”

These two parameters are for setting to recall or storage scene when long/short operation. Options:

- No reaction**
- Recall scene**
- Store scene**

—Parameter “8 bit scene number”

This parameter is visible when “No reaction” is not selected. Set the scene number. Options:

- Scene NO.1**
- Scene NO.2**
- Scene NO.3**
- ...
- Scene NO.64**

Corresponding telegram is 0~63

Parameter “Number of objects”

This parameter is visible when the parameter “Reaction on long operation” is not selected “No reaction”. Set the number of objects when short/long operation. Options:

- 1**
- 2**



## 8.Blind function

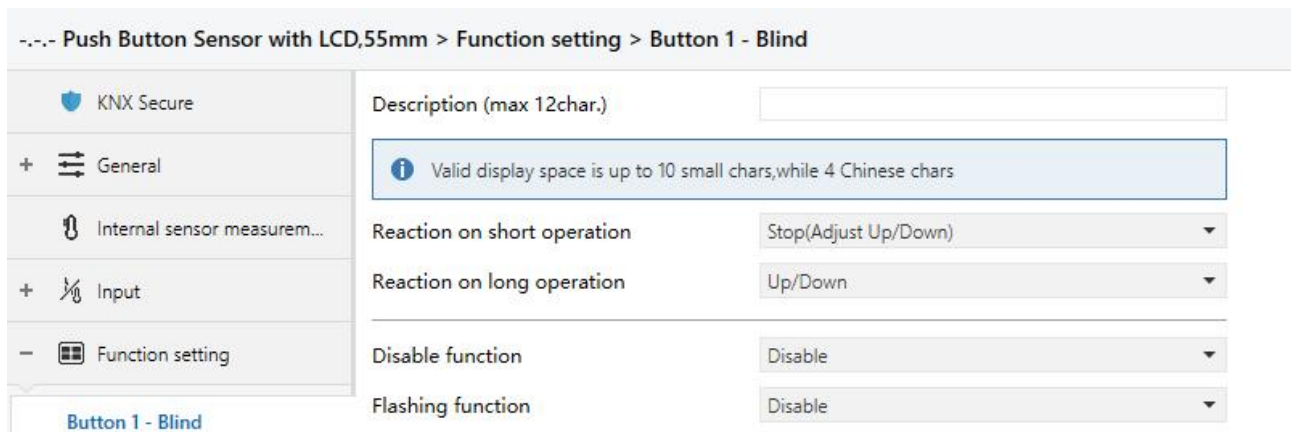

Fig.5.5.1.1(8) Parameter setting of blind function

Parameter “Reaction on short operation”

Parameter “Reaction on long operation”

These two parameters are for setting to performed actions when long/short operation. Options:

**No reaction**

**Up**

**Down**

**Up/Down**

**Stop(Adjust Up)**

**Stop(Adjust Down)**

**Stop(Adjust Up/Down)**

No action: no action is performed.

Up: the curtains/blinds will be opened or moved up.

Down: the curtains/blinds will be closed or moved down.

Up/Down: alternately open/close or move up/down the curtains/blinds.

Stop (Adjust Up): stop the curtain movement or move up the angle of blinds.

Stop (Adjust Down): stop the curtain movement or move down the angle of blinds.

Stop (Adjust Up/Down): stop the curtain movement or move up/down the angle of blinds alternately.

—Parameter “Interval of tele. cyclic send [0..25,0=send once]\*0.1s”

This parameter is visible when the parameter “Reaction on long operation” is selected “Stop...”. Set the time interval of cyclical blinds angle adjustment telegram sent. Options: **0..25,0=send once**

## 9.Shift register function

--- Push Button Sensor with LCD,55mm > Function setting > Button 1 - Shift register

<ul style="list-style-type: none"> <li>KNX Secure</li> <li>+ General</li> <li>Internal sensor measurem...</li> <li>+ Input</li> <li>- Function setting</li> <li><b>Button 1 - Shift register</b></li> <li>Customized colour</li> <li>+ Logic function</li> <li>+ Scene Group function</li> </ul>	<p>Description (max 12char.) <input type="text"/></p> <p><b>i</b> Valid display space is up to 10 small chars,while 4 Chinese chars</p> <p>Shift type <input checked="" type="radio"/> Shift by step value  <input type="radio"/> Shift without step value</p> <p>Value begin with <input type="text" value="0"/></p> <p>Value end with(must be larger than value begin with) <input type="text" value="10"/></p> <p>Step size <input type="text" value="2"/></p> <p>Direction <input type="text" value="From lowest to highest and cyclically"/></p> <p>Reset function <input checked="" type="radio"/> Disable <input type="radio"/> Enable by long operation</p> <hr/> <p>Disable function <input type="text" value="Disable"/></p>
--	--

Fig.5.5.1.1(9) Parameter setting of shift register function

### Parameter “Shift type”

This parameter is for setting the shift type. Options:

#### Shift by step value

#### Shift without step value

Shift by step value: Here the starting value and stopping value of shift can be set, the value increased (from low to high) or decreased (from high to low) from every shift can also be set.

Shift without step value: When there’s no step value, the actual value sent by each shift can be set (max. 10 value), in every operation one value will be sent.

**Three parameters as follow are visible when “Shift by step value” is selected.**

#### —Parameter “Value begin with”

This parameter is for setting the starting value of the shift. Options: **0..240**

#### —Parameter “Value end with(must be larger than value begin with)”

This parameter is for setting the stopping value of the shift. Options: **1..250**

**Note: the values must meet the condition: end value > begin value, if not, they can not be modified on**

**ETS, and display red box warning, as shown as follow:**

Value begin with	<input type="text" value="4"/>
Value end with(must be larger than value begin with)	<input type="text" value="1"/>

——Parameter “Step size”

This parameter is for setting the increase (from low to high) or decrease (from high to low) value.

Options: **0..240**

**Parameters as follow are visible when “Shift without step value” is selected.**

**Parameter “Object datatype”**

This parameter is for setting the object datatype for the shift object. Options:

**1byte unsigned value**

**Scene number**

**HVAC mode**

——Parameter “Shift number”

This parameter is for setting the number of shift, up to set 10 values.

When “1byte unsigned value” or “Scene number” is selected, options: **0/1/2../10**

When “HVAC mode” is selected, options: **1/2/3/4**

——Parameter “Value x”(x=1~10 or x=1~4)

此 Parameter 用于每次移位操作所发送的值。

When “1byte unsigned value” is selected, options: **0..255**

When “Scene number” is selected, options:

**Scene NO.1**

**Scene NO.2**

**Scene NO.3**

...

**Scene NO.64**

When “HVAC mode” is selected, options:

**Comfort mode**

**Standby mode**

**Economy mode**

**Frost/heat protection**

#### Parameter "Direction"

This parameter is for setting the shift direction. Options:

**From lowest to highest and stop to the end**

**From highest to lowest and stop to the begin**

**From lowest to highest and cyclically**

**From highest to lowest and cyclically**

From lowest to highest and stop to the end: shift from low to high.

From highest to lowest and stop to the begin: shift from high to low.

From lowest to highest and cyclically: once to the end value, shift direction starts over again and constantly cycling from low to high operation.

From highest to lowest and cyclically: once to the start value, shift direction starts over again and constantly cycling from high to low operation.

#### Parameter "Reset function"

This parameter is for setting whether to enable shift reset function. Options:

**Disable**

**Enable by long operation**

Disable: not possible to reset shift;

Enable by long operation: possible to reset shift by long operation, when reset, shift will start new.

## 10. Multiple operation function

--- Push Button Sensor with LCD,55mm > Function setting > Button 1 - Multiple operation

<ul style="list-style-type: none"> <li>KNX Secure</li> <li>+ General</li> <li>Internal sensor measurem...</li> <li>+ Input</li> <li>- Function setting</li> <li><b>Button 1 - Multiple operation</b></li> <li>Customized colour</li> <li>+ Logic function</li> <li>+ Scene Group function</li> </ul>	<p>Description (max 12char.) <input type="text"/></p> <p><b>i</b> Valid display space is up to 10 small chars,while 4 Chinese chars</p> <p>Object type for object1 <span style="float: right;">1Bit_On/Off ▼</span></p> <p>Function of short operation <span style="float: right;">TOGGLE ▼</span></p> <p>Function of long operation <span style="float: right;">No reaction ▼</span></p> <p>Object type for object2 <span style="float: right;">1Bit_On/Off ▼</span></p> <p>Function of short operation <span style="float: right;">TOGGLE ▼</span></p> <p>Function of long operation <span style="float: right;">No reaction ▼</span></p> <p>Object type for object3 <span style="float: right;">Disable ▼</span></p> <p>Object type for object4 <span style="float: right;">Disable ▼</span></p> <hr/> <p>Disable function <span style="float: right;">Disable ▼</span></p>
--	--

Fig.5.5.1.1(10) Parameter setting of multiple operation function

### Parameter "Object type for object x"(x=1~4)

This parameter is for setting the datatype when long/short operation to send. Options:

- Disable**
- 1Bit\_On/Off**
- 1Bit\_Up/Down**
- 1Byte\_RecallScene**
- 1Byte\_StoreScene**
- 1Byte\_Percentage**
- 1Byte\_Unsigned value**
- 14Byte\_String**

**Note: only object 1 and short operation support to send 14byte string.**

—Parameter "Function of short operation"

—Parameter "Function of long operation"

These two parameters are for setting the specific values to send when perform the operation, either no action or sending value.

When "1Bit\_On/Off" is selected, options:

- No reaction**
- OFF**

**ON**

**TOGGLE**

When “1Bit\_Up/Down” is selected, options:

**No reaction**

**Up**

**Down**

**Up/Down**

When “1byte...” or “14Byte\_String” is selected, options:

**No reaction**

**Send Value**

——Parameter “Value x...” (x=1~2)

This parameter is visible when “1byte...” is selected and previous parameter is selected “Send Value”. Set sending values when perform operations. The range of value is up to the datatype selected by the parameter before last one.

——Parameter “String (10byte) value”

This parameter is visible when “14Byte\_String” is selected and previous parameter is selected “Send Value”. Set sending string when perform operations, up to input 10 characters.

## 11.Delay mode function

--- Push Button Sensor with LCD,55mm > Function setting > Button 1 - Delay mode

<ul style="list-style-type: none"> <li>KNX Secure</li> <li>General</li> <li>Internal sensor measurem...</li> <li>Input</li> <li>Function setting</li> <li><b>Button 1 - Delay mode</b></li> <li>Customized colour</li> <li>Logic function</li> </ul>	<p>Description (max 12char.) <input type="text"/></p> <p><b>i</b> Valid display space is up to 10 small chars,while 4 Chinese chars</p> <p>Object type for short operation: 1Bit_On/Off</p> <p>Send mode: No action when operation,delay then send value1</p> <p>Delay time [0..6500]: 10 s</p> <p>Value 1: <input checked="" type="radio"/> OFF <input type="radio"/> ON</p> <p>Value 2: <input type="radio"/> OFF <input checked="" type="radio"/> ON</p> <p>Object type for long operation: Disable</p> <hr/> <p>Disable function: Disable</p>
--	---

Fig.5.5.1.1(11) Parameter setting of delay mode function

Parameter "Object type for short operation"

Parameter "Object type for long operation"

These two parameters are for setting the datatype when long/short operation to send. Options:

**Disable**

**1Bit\_On/Off**

**4Bit\_Dimming**

**1Byte\_Unsigned value**

These three parameters as follow are not visible when "Disable" is selected.

—Parameter "Send mode"

This parameter is for setting the send mode. Options:

**No action when operation,delay then send value1**

**No action when operation,delay then send value2**

**Send value1 when operation,delay then send value2**

**Send value2 when operation,delay then send value1**

—Parameter "Delay time [0..6500]s"

This parameter is for setting the delay time. Options: **0..6500**

—Parameter "Value x" (x=1~2)

This parameter is for setting the value 1/2 to send. The range of value is up to the datatype selected by the parameters.

## 12.RTC operation mode

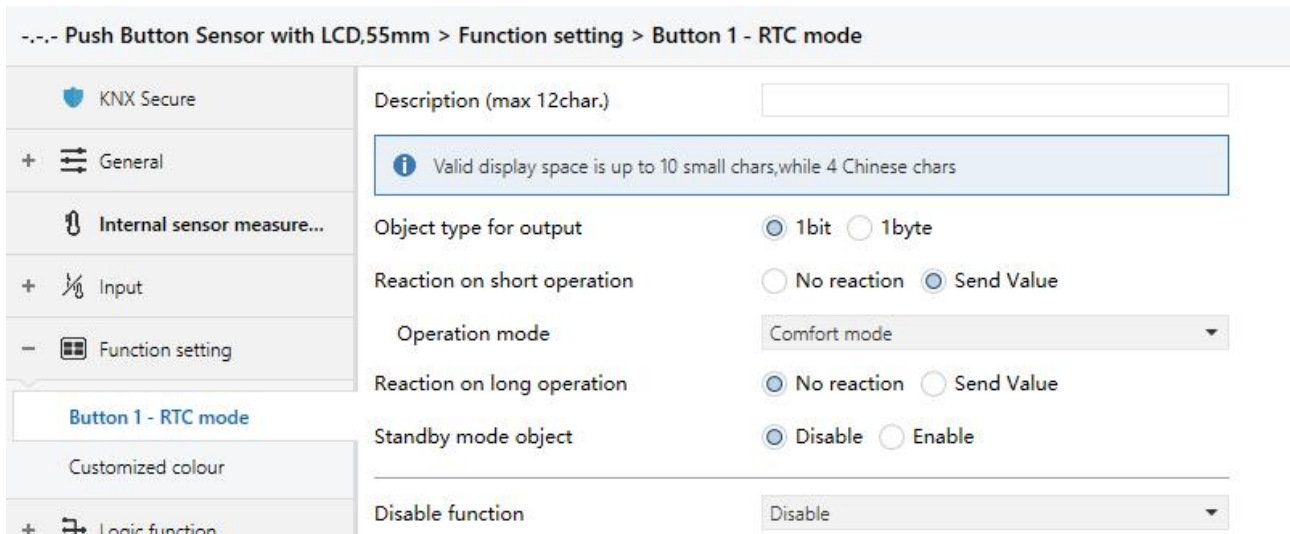

Fig.5.5.1.1(12) Parameter setting of RTC operation mode

### Parameter “Object type for output”

This parameter is for setting object datatype for output. Options:

**1bit**

**1byte**

### Parameter “Reaction on short operation”

### Parameter “Reaction on long operation”

These two parameters are for setting the performed operation when long/short operation. Options:

**No reaction**

**Send Value**

### —Parameter “Operation mode”

This parameter is visible when “Send Value” is selected. Set the operation mode of RTC. Options:

**Auto**

**Comfort mode**

**Standby mode**

**Economy mode**

**Frost/heat protection**

Activate corresponding modes when object telegram is 1, and not activated when object telegram is 0. It is standby mode when all objects telegrams are 0.



**Note: There is no “Auto” selected when output object is 1 bit.**

**Parameter “Standby mode object”**

Consider that some products will not have this object, so that set the object, send telegram 1 when standby mode.

This parameter is visible when 1bit is selected. Set whether to enable the object of standby mode. Options:

**Disable**

**Enable**

**13.String(14bytes) function**

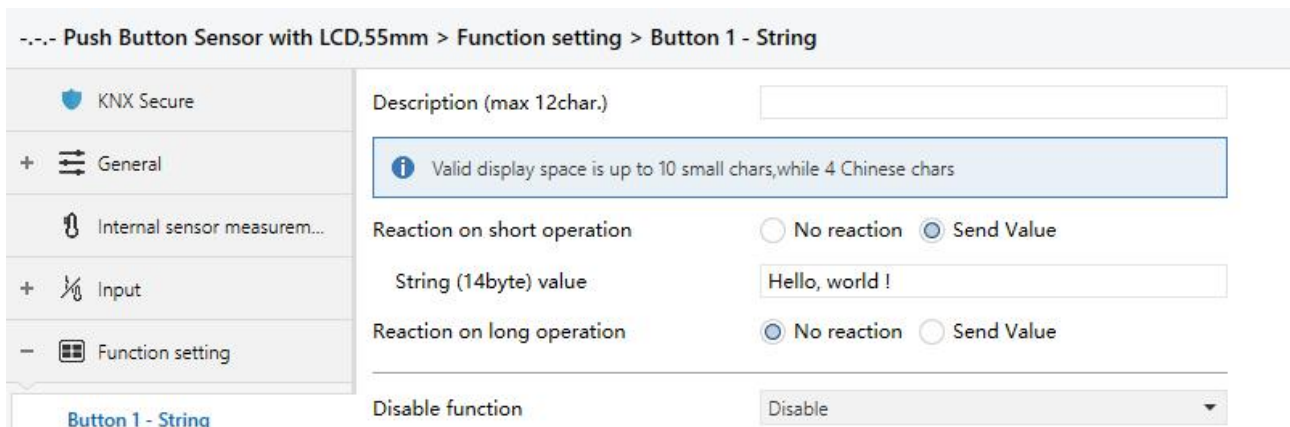

Fig.5.5.1.1(13) Parameter setting of sting(14bytes) function

**Parameter “Object type for short operation”**

**Parameter “Object type for long operation”**

These two parameters are for setting the performed operation when long/short operation. Options:

**No reaction**

**Send Value**

**—Parameter “String (14byte) value”**

This parameter is visible when “Send Value” is selected. Set the sting value to send.

## 14. Status display

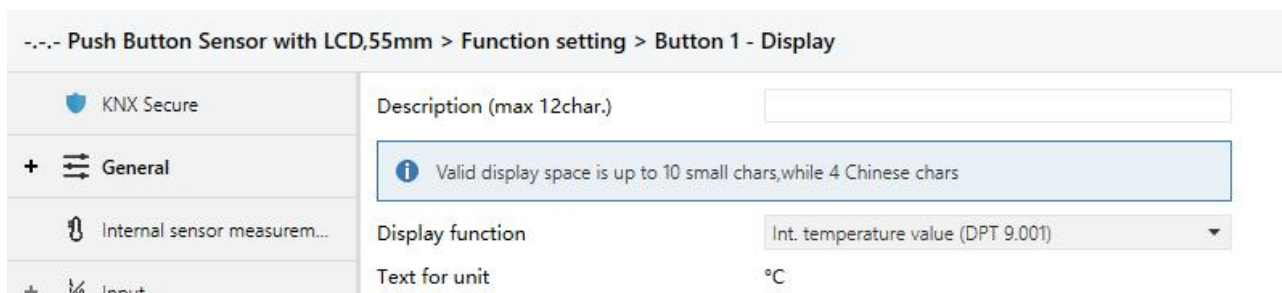

Fig.5.5.1.1(14) Parameter setting of status display

### Parameter “Display function”

This parameter is for setting the datatype of status display. Options:

<b>Int. temperature value (DPT 9.001)</b>	<b>2byte unsigned value (DPT 7.001)</b>
<b>Int. humidity value (DPT 9.007)</b>	<b>2byte lux value (DPT 9.004)</b>
<b>Ext. temperature value (DPT 9.001)</b>	<b>2byte float value (DPT 9.x)</b>
<b>Ext. humidity value (DPT 9.007)</b>	<b>4byte unsigned value (DPT 12.001)</b>
<b>1byte percent value (DPT 5.001)</b>	<b>4byte float value (DPT 14.x)</b>
<b>1byte unsigned value (DPT 5.010)</b>	<b>14byte strings (DPT 16.001)</b>

There are no unit and time period for request external value when “14byte strings (DPT 16.001)” is selected, following two parameters are not visible.

#### —Parameter “Text for unit”

This parameter is for setting the unit of the selected object datatype.

When “...temperature...” is selected, the unit is fixed as °C

When “...humidity...” or “1byte percent value...” is selected, the unit is fixed as %

When the other options are selected, up to input 5 characters.

### Parameter “Time period for request external value [0..255]min”

This parameter is visible when the datatype of external sensor is selected. Set the time period for read request external temperature sensor. Options: **0..255**

**Note: when internal sensor is selected, it will not send read request to the bus after voltage recovery and download completion.**

## 15.RGB dimming

--- Push Button Sensor with LCD,55mm > Function setting > Button 1 - RGB dimming

KNX Secure

+ General

Internal sensor measurem...

+ Input

- Function setting

**Button 1 - RGB dimming**

Customized colour

+ Logic function

+ Scene Group function

Description (max 12char.)

**i** Valid display space is up to 10 small chars,while 4 Chinese chars

Reaction on short operation Switch toggle

Reaction on long operation Enter into the sub dimming page

Sub dimming page preview



Button 1	press to select to adjust H value	Button 2	press to select to adjust S value
Button 3	press to select to adjust V value	Button 4	NA
Button 5	press to decrease value	Button 6	press to increase value

Object datatype 1x3byte

Reaction on "off" operation

Only switch object send value 0  
 Brightness objects send value 0

Reaction on "on" operation

Only switch object send value 1  
 Preset colour brightness value

---

Step of H (hue) 10 °

Step of S (saturation) 5 %

Step of V (value) 5 %

---

Disable function Disable

图 5.5.1.1(15) Parameter setting of RGB dimming

Parameter "Reaction on short operation"

Parameter "Reaction on long operation"

These two parameters are for explaining the reaction on short/long operation. Short operation default to switch between on and off, and long operation is to enter the sub dimming page.

Display sub dimming page preview and the button operations below these parameters, specific UI description please refer to Chapter 7.1.1.

Parameter "Object datatype"

This parameter is for setting the object datatype of RGB dimming. Option is only **1x3byte**

Parameter "Reaction on "off" operation"

This parameter is for setting the sent telegram when "off" operation, you can choose only switch object send value 0, or the brightness objects send value 0. Options:

**Only switch object send value 0**

**Brightness objects send value 0**

Parameter "Reaction on "on" operation"

This parameter is for setting the sent telegram when "on" operation, you can choose only switch object send value 1, or the colour brightness objects send presetting value. Options:

**Only switch object send value 1**

**Preset colour brightness value**

—Parameter "RGB value"

This parameter is visible when "Preset colour brightness value" is selected. Set the sending RGB value.

Options: #000000 ....#FFFFFF

Parameter "Step of H (hue)"

This parameter is for setting the step value of Hue. Options:

**10°**

...

**40°**

**60°**

Parameter "Step of S (saturation)"

This parameter is for setting the step value of Saturation. Options:

**5%**

**10%**

**20%**

Parameter "Step of V (value)"

This parameter is for setting the step value of Value. Options:

**5%**

**10%**

**20%**

## 16.RGBW dimming

--- Push Button Sensor with LCD,55mm > Function setting > Button 1 - RGBW dimming

KNX Secure

+ General

Internal sensor measurem...

+ Input

- Function setting

**Button 1 - RGBW dimming**

Customized colour

+ Logic function

+ Scene Group function

Description (max 12char.)

**i** Valid display space is up to 10 small chars,while 4 Chinese chars

Reaction on short operation Switch toggle

Reaction on long operation Enter into the sub dimming page

Sub dimming page preview



Button 1	press to select to adjust H value	Button 2	press to select to adjust S value
Button 3	press to select to adjust V value	Button 4	press to select to adjust W value
Button 5	press to decrease value	Button 6	press to increase value

Object datatype  1x6byte  3byte+1byte

Reaction on "off" operation  Only switch object send value 0  
 Brightness objects send value 0

Reaction on "on" operation  Only switch object send value 1  
 Preset colour brightness value

---

Step of H (hue)  °

Step of S (saturation)  %

Step of V (value)  %

Step of W(white brightness)  %

---

Disable function

图 5.5.1.1(16) Parameter setting of RGBW dimming

Parameter "Reaction on short operation"

Parameter "Reaction on long operation"

These two parameters are for explaining the reaction on short/long operation. Short operation default to switch between on and off, and long operation is to enter the sub dimming page.

Display sub dimming page preview and the button operations below these parameters, specific UI description please refer to Chapter 7.1.2.

Parameter "Object datatype"

This parameter is for setting the object datatype of RGBW dimming. Options:

**1x6byte**

**3byte+1byte**

#### Parameter "Reaction on "off" operation"

This parameter is for setting the sent telegram when "off" operation, you can choose only switch object send value 0, or the brightness objects send value 0. Options:

**Only switch object send value 0**

**Brightness objects send value 0**

#### Parameter "Reaction on "on" operation"

This parameter is for setting the sent telegram when "on" operation, you can choose only switch object send value 1, or the colour brightness objects send presetting value. Options:

**Only switch object send value 1**

**Preset colour brightness value**

—Parameter "RGB value"

This parameter is visible when "Preset colour brightness value" is selected. Set the sending RGB value.

Options: #000000 ....#FFFFFF

—Parameter "White brightness value"

This parameter is visible when "Preset colour brightness value" is selected. Set the sending white brightness value. Options: **0..100%**

#### Parameter "Step of H (hue)"

This parameter is for setting the step value of Hue. Options:

**10°**

...

**40°**

**60°**

#### Parameter "Step of S (saturation)"

This parameter is for setting the step value of Saturation. Options:

**5%**

**10%**

20%

Parameter "Step of V (value)"

This parameter is for setting the step value of Value. Options:

5%

10%

20%

Parameter "Step of W(white brightness)"

This parameter is for setting the step value of white brightness. Options:

5%

10%

20%

### 17.Colour temperature dimming

--- Push Button Sensor with LCD,55mm > Function setting > Button 1 - Colour Temp. dimming

KNX Secure

+ General

Internal sensor measurem...

+ Input

- Function setting

**Button 1 - Colour Temp. dim...**

Customized colour

+ Logic function

+ Scene Group function

Description (max 12char.)

*Valid display space is up to 10 small chars,while 4 Chinese chars*

Reaction on short operation

Reaction on long operation

Sub dimming page preview

Switch toggle

Enter into the sub dimming page



Button 1	press to decrease colour temperature	Button 2	press to increase colour temperature
Button 3	press to decrease brightness	Button 4	press to increase brightness
Button 5	NA	Button 6	NA

Object datatype of colour temperature  1byte percentage value  2byte absolute value

Reaction on "off" operation  Only switch object send value 0  Brightness objects send value 0

Reaction on "on" operation  Only switch object send value 1  Preset colour brightness value

图 5.5.1.1(17) Parameter setting of colour temperature dimming



## Parameter “Reaction on short operation”

## Parameter “Reaction on long operation”

These two parameters are for explaining the reaction on short/long operation. Short operation default to switch between on and off, and long operation is to enter the sub dimming page.

Display sub dimming page preview and the button operations below these parameters, specific UI description please refer to Chapter 7.1.3.

## Parameter “Object datatype of colour temperature”

This parameter is for setting the object datatype of colour temperature dimming. Options:

**1byte percentage value**

**2byte absolute value**

When “1byte percentage value” is selected, it applies to the products of colour temperature with 0/1-10V drive. Control telegram is percentage type, and the step value is set via ETS, show the absolute colour temperature on the screen instead of percent value. Telegram range is 0~100%.

While “2byte absolute value” is selected, it applies to the products that support KNX colour temperature. Control telegram is absolute colour temperature type, and the step value is set via ETS, show directly the absolute colour temperature on the screen. Telegram range is depend on the configuration of Max./Min. parameters.

## Parameter “Reaction on “off” operation”

This parameter is for setting the sent telegram when “off” operation, you can choose only switch object send value 0, or the brightness objects send value 0. Options:

**Only switch object send value 0**

**Brightness objects send value 0**

## Parameter “Reaction on “on” operation”

This parameter is for setting the sent telegram when “on” operation, you can choose only switch object send value 1, or the colour brightness objects send presetting value. Options:

**Only switch object send value 1**

**Preset colour brightness value**

—Parameter “**Brightness is**”

This parameter is visible when “Preset colour brightness value” is selected. Set the sending brightness value.



Options: **0..100%**

Parameter "Min./Max. colour temperature [2000..7000]K"

These two parameters are for setting the adjustable range of colour temperature. Options: **2000..7000**

**For colour temperature, the Min. value must less than the Max., if not, if not, they can not be modified on ETS, and display red box warning, as shown as follow:**

Min. colour temperature [2000..7000]	<input type="text" value="6500"/>	▲▼	K
Max. colour temperature [2000..7000]	<input type="text" value="6500"/>	▲▼	K

Parameter "Step of colour temperature"

This parameter is for setting the step value of colour temperature. Options:

- 100K**
- 200K**
- 500K**
- 1000K**

Parameter "Step of brightness"

This parameter is for setting the step value of brightness. Options:

- 5%**
- 10%**
- 20%**

5.5.1.2. Status indication of individual button

+  Logic function		Status indication	Via button switch status object
+  Scene Group function		Indication type	Icon + Description of button
		Icon for object value=1	Light on
		Colour for object value=1	Orange
		Icon for object value=0	Light off
		Colour for object value=0	Foreground
Via button switch status object			
+  Logic function		Status indication	Via external status object 1 bit
+  Scene Group function		Indication type	Icon + Description of button
		Icon for object value=1	Light on
		Colour for object value=1	Orange
		Icon for object value=0	Light off
		Colour for object value=0	Foreground
Via external status object 1 bit			
+  Logic function		Status indication	Via external status object 1 byte
+  Scene Group function		Indication type	Icon + Description of button
		Object datatype	<input type="radio"/> 1byte[0..255] <input checked="" type="radio"/> 1byte[0..100%]
		Threshold compare type	<input checked="" type="radio"/> Between the threshold value <input type="radio"/> Equal to the threshold value
		Number of threshold	2
		Threshold value 1 is	0 %
		Threshold value 2 is	20 %
		<b>If object value &lt;= threshold value 1</b>	
		Icon is	Light on
		Colour is	Foreground
		<b>If threshold value 1 &lt; object value &lt;= threshold value 2</b>	
		Icon is	Light on
		Colour is	Red
		<b>If object value &gt; threshold value 2</b>	
		Icon is	Light on
		Colour is	Dark green
Via external status object 1 byte			
+  Logic function		Status indication	Always
+  Scene Group function		Indication type	Icon + Description of button
		Icon for indication	Light on
		Colour for indication	Foreground

Always

Fig.5.5.1.2 Parameter setting of status indication of individual button

**Note: when 1 page is selected, Button 5 and Button 6 only support the scene function, and not support to the following configuration.**

## Parameter "Status indication"

This parameter is for setting the status indication of button.

When button with switch function, including switch, dimming, RGB switching/send value, RGB switching/send value, colour temperature switching/send value, RGB dimming, RGBW dimming or colour temperature dimming. Options:

**Via button switch status object**

**Via external status object 1 bit**

**Via external status object 1 byte**

**Always**

When button without switch function, including value sender, scene control, blind, shift register, multiple operation, delay mode or RTC operation mode. Options:

**Via external status object 1 bit**

**Via external status object 1 byte**

**Always**

**Indicate button press**

When string(14bytes) is selected, options:

**Always**

**Indicate button press**

When status display is selected, option is only **Always**

Via button switch status object: indicate the status via the value feed back form the switch status object;

Via external status object 1 bit: indicate the status via the value feed back form the 1 bit external object;

Via external status object 1 byte: indicate the status via comparing the value feed back form the 1 byte external object to the threshold value;

Always: always indicate in the same status.

Indicate button press: flashing twice (0.5s on and 0.5s off) when press button, then return to normal indication, if there is another press during the flashing cycle, not reset the cycle.

Parameter "Indication type"

This parameter is for setting the indication type of button.

When you select the function: switch,dimming, RGB switching/send value, RGB switching/send value, colour temperature switching/send value, value sender, scene control, blind, shift register, multiple operation, delay mode, RTC operation mode, RGB dimming, RGBW dimming or colour temperature dimming. Options:

**Description of button**

**Icon only**

**Icon + Description of button**

When string(14bytes) or status display is selected, there is no **Icon + Description of button** in the above options.

The description of button is configured via the parameter "Description (max 12char.)".

**Parameters as follow are visible when status indication is selected "Via button switch status object" or "External status object 1 bit":**

Parameter "Icon for object value=1"

Parameter "Icon for object value=0"

These two parameters are visible when indication type is selected "Icon...". Set the icon for object value=1 or value =0. Options:

**Light on**

**Light off**

...

**PM10**

The default icons corresponding to the function and the icons corresponding to the options are described in chapter 8.1.

Parameter "Colour for object value=1"

Parameter "Colour for object value=0"

These two parameters are for setting the colour of icon and text when status object telegram value is 1 or 0. Options:

**Foreground**

**Cyan blue**

<b>Red</b>	<b>Cyan</b>
<b>Dark green</b>	<b>Coffee</b>
<b>Blue</b>	<b>Light orange</b>
<b>Yellow</b>	<b>Customized colour 1</b>
<b>Orange</b>	<b>Customized colour 2</b>
<b>Purple</b>	<b>Customized colour 3</b>
<b>Grey</b>	<b>Customized colour 4</b>
<b>Pink</b>	<b>Customized colour 5</b>

**Parameters as follow are visible when status indication is selected “Via external status object 1 byte”:**

#### Parameter “Object datatype”

This parameter is for setting the object datatype of status indication. Options:

**1byte[0..255]**

**1byte[0..100%]**

#### Parameter “Threshold compare type”

This parameter is for setting the threshold compare type, you can select to display when between the threshold value, or equal to the threshold value. Options:

**Between the threshold value**

**Equal to the threshold value**

#### Parameter “Number of threshold”

This parameter is for setting the number of threshold compare.

When “Between the threshold value” is selected, options: **1 / 2 / 3 / 4**

When “Equal to the threshold value” is selected, options: **1 / 2 / 3 / 4 / 5**

#### Parameter “Threshold value x is” (x=1-5)

This parameter is for setting threshold value, status indication is via comparing between input value and threshold value.

Options display according to the object datatype: **0..255 / 0..100**

According to the threshold compare type and the number of threshold compare, you can set the icon and

colour to display which match the threshold compare. Parameters as follow:

—Parameter “Icon is”

This parameter is visible when indication type is selected “Icon...”. Set the icon to display which matches the threshold compare. Options:

**Light on**

**Light off**

...

**PM10**

The default icons corresponding to the function and the icons corresponding to the options are described in chapter 8.1.

—Parameter “Colour is”

This parameter is for setting the colour of icon and text which matches the threshold compare. Options:

<b>Foreground</b>	<b>Cyan blue</b>
<b>Red</b>	<b>Cyan</b>
<b>Dark green</b>	<b>Coffee</b>
<b>Blue</b>	<b>Light orange</b>
<b>Yellow</b>	<b>Customized colour 1</b>
<b>Orange</b>	<b>Customized colour 2</b>
<b>Purple</b>	<b>Customized colour 3</b>
<b>Grey</b>	<b>Customized colour 4</b>
<b>Pink</b>	<b>Customized colour 5</b>

**Parameters as follow are visible when status indication is selected “Always”:**

**Parameter “Icon for indication”**

This parameter is visible when indication type is selected “Icon...”. Set the icon to display for status indication. Options:

**Light on**

**Light off**

...

**PM10**

The default icons corresponding to the function and the icons corresponding to the options are described in chapter 8.1.

**Parameter "Colour for indication"**

This parameter is for setting the colour for status indication. Options:

<b>Foreground</b>	<b>Cyan blue</b>
<b>Red</b>	<b>Cyan</b>
<b>Dark green</b>	<b>Coffee</b>
<b>Blue</b>	<b>Light orange</b>
<b>Yellow</b>	<b>Customized colour 1</b>
<b>Orange</b>	<b>Customized colour 2</b>
<b>Purple</b>	<b>Customized colour 3</b>
<b>Grey</b>	<b>Customized colour 4</b>
<b>Pink</b>	<b>Customized colour 5</b>

5.5.1.3.Rocker button

1.Switch function

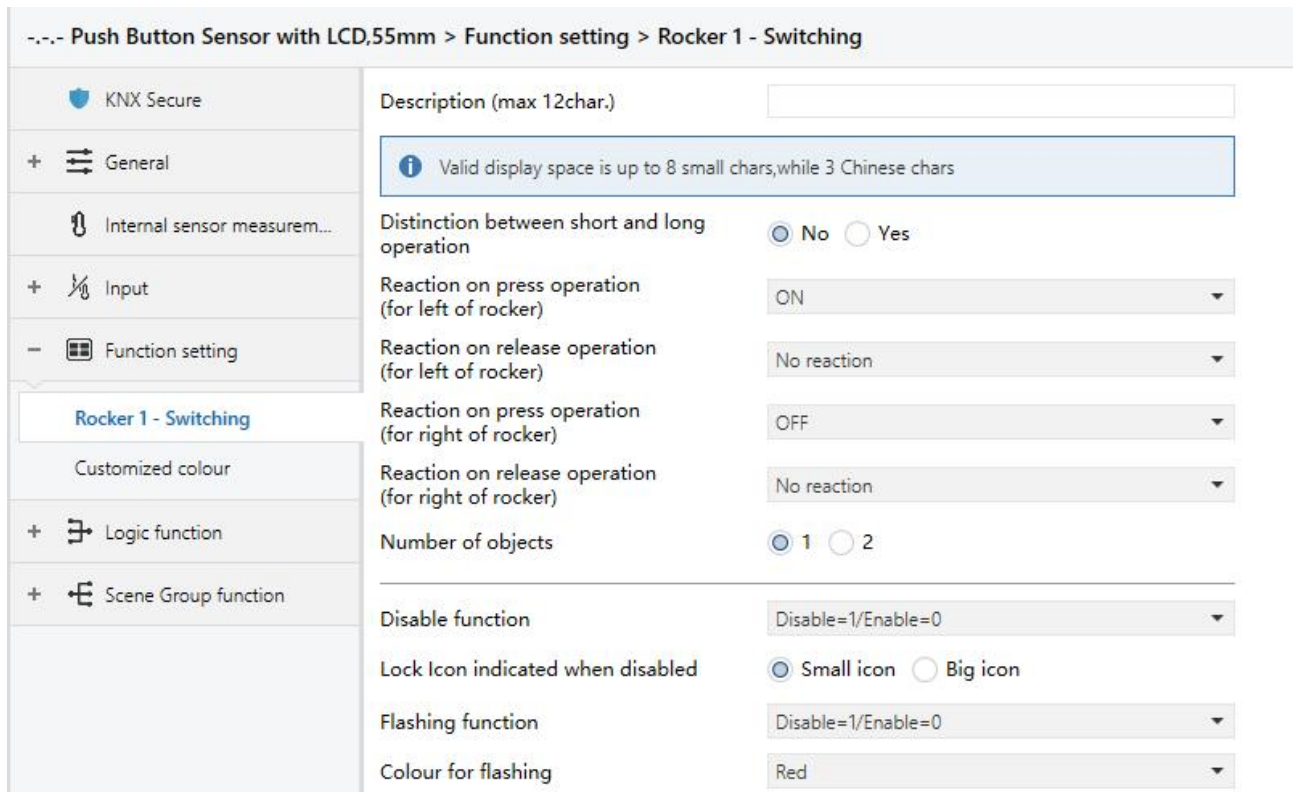

Fig.5.5.1.3(1) Parameter setting of switch function

Parameter “Description (max 12char.)”

This parameter is for setting the description of rocker button, up to input 12 characters



Parameter “Distinction between short and long operation”

This parameter is for setting whether to distinction the contact operation between short and long operation.

Options:

No

Yes

Parameter “Reaction on short/press operation (for left/right of rocker)”

Parameter “Reaction on long/release operation (for left/right of rocker)”

These parameters are for setting the performed actions for left/right of rocker buttons when press/release the contact or long/short operation. The object value is updated when the input is determined. Options:



**No reaction**

**OFF**

**ON**

**TOGGLE**

No action: no telegrams have been sent.

ON: send the on telegram.

OFF: send the off telegram.

TOGGLE: each operation will switch between on and off. For example, if the last telegram was sent (or received) for on, then the next operation will trigger a telegram for off. When the switch is operated again, it will send a telegram for on etc., So the switch will always record the previous state and convert to opposite value during next operation.

#### Parameter "Number of objects"

This parameter is for setting the number of objects when short/long or press/release operation:

**1**

**2**

#### Parameter "Disable function"

This parameter is for setting trigger value to disable/enable contacts. Options:

**Disable**

**Disable=1/Enable=0**

**Disable=0/Enable=1**

#### Parameter "Lock icon indicated when disabled"

This parameter is visible when "Disable=1/Enable=0" or "Disable=0/Enable=1" is selected. Set the icon size when the button is in disable status. Options:

**Small icon**

**Big icon**

Big icon is the lock icon replaces the original icon, while small icon is the two icons coexist and the lock icon is a small icon in right corner. Specific effect please refer to UI description.

Parameter "Flashing function"

This parameter is for setting whether to enable flashing function. Options:

**Disable**

**Disable=1/Enable=0**

**Disable=0/Enable=1**

Parameter "Colour for flashing"

This parameter is visible when previous parameter is selected "Disable=1/Enable=0" or "Disable=0/Enable=1". Set the colour for flashing. Options:

<b>Foreground</b>	<b>Cyan blue</b>
<b>Red</b>	<b>Cyan</b>
<b>Dark green</b>	<b>Coffee</b>
<b>Blue</b>	<b>Light orange</b>
<b>Yellow</b>	<b>Customized colour 1</b>
<b>Orange</b>	<b>Customized colour 2</b>
<b>Purple</b>	<b>Customized colour 3</b>
<b>Grey</b>	<b>Customized colour 4</b>
<b>Pink</b>	<b>Customized colour 5</b>

**Note: flashing function is only used for "Switch", "Dimming" and "Blind".**

**The flashing function takes precedence over normal status indications, and return to normal indication when cancel flashing. Specific flashing effect please refer to Chapter 7.1.**

Repeat parameters will not be illustrated below; the usage is similar.

## 2. Dimming function

--- Push Button Sensor with LCD,55mm > Function setting > Rocker 1 - Dimming

<ul style="list-style-type: none"> <li>🔒 KNX Secure</li> <li>+ ☰ General</li> <li>📏 Internal sensor measurem...</li> <li>+ 📡 Input</li> <li>- 🗄️ Function setting</li> <li style="background-color: #e0e0e0;">Rocker 1 - Dimming</li> <li>🎨 Customized colour</li> <li>+ 🔄 Logic function</li> <li>+ 🏠 Scene Group function</li> </ul>	<p>Description (max 12char.) <input type="text"/></p> <p><b>i</b> Valid display space is up to 8 small chars,while 3 Chinese chars</p> <p>Reaction on short operation (for left of rocker) <input type="text" value="ON"/></p> <p>Reaction on long operation (for left of rocker) <input type="text" value="Brighter"/></p> <p>Reaction on short operation (for right of rocker) <input type="text" value="OFF"/></p> <p>Reaction on long operation (for right of rocker) <input type="text" value="Darker"/></p> <p>Dimming mode <input checked="" type="radio"/> Start-Stop dimming <input type="radio"/> Step dimming</p> <hr/> <p>Disable function <input type="text" value="Disable"/></p> <p>Flashing function <input type="text" value="Disable"/></p>
--	---

Fig.5.5.1.3(2) Parameter setting of dimming function

### Parameter "Reaction on short operation (for left/right of rocker)"

These two parameters are for setting the sending switch value for left/right of rocker buttons when short operation. Options:

**No reaction**

**OFF**

**ON**

**TOGGLE**

No action: no telegrams have been sent.

ON: send the on telegram.

OFF: send the off telegram.

TOGGLE: each operation will switch between on and off.

### Parameter "Reaction on long operation (for left/right of rocker)"

These two parameters are for setting the sending relative dimming value for left/right of rocker buttons when long operation, with dimming brighter or darker; when release the contact stop dimming. Options:

**No reaction**

**Brighter**

**Darker**

### **Brighter/Darker**

No action: no telegrams have been sent.

Brighter: the dimming up value will be sent.

Darker: the dimming down value will be sent.

Brighter/Darker: dimming up and down will be sent alternately.

**Note: in “TOGGLE” mode of this parameter setting, the value sent will be linked. For example, if the last value is switching on status, then it will be dimmed down in next dimming operation; if the last value is switching off, then it will be dimmed up in next dimming operation.**

### **Parameter “Dimming mode”**

This parameter is for setting the way of relative dimming. Options:

#### **Start-Stop dimming**

#### **Step dimming**

Start-stop dimming: the dimming mode will be start-stop, a dimming up or down telegram will be sent when the dimming starts, and a stop telegram will be sent when dimming ends. Here the dimming telegram will not be sent cyclically.

Steps dimming: the dimming mode will be a step one and the dimming telegram will be sent cyclically. When dimming ends, a stop dimming telegram will be sent immediately.

#### **—Parameter “ Step size”**

This parameter is visible when the dimming way is selected “Step dimming”. Set a cyclically sending dimming telegram which changes the brightness percentage, Options:

**100%**

**50%**

**...**

**1.56%**

#### **—Parameter “ Interval of tele. cyclic send [0..25,0=send once]\*0.1s”**

This parameter is visible when the dimming way is selected “Step dimming”. Set intervals of telegram cyclically sending dimming telegram. Options: **0..25, 0=send once**

### 3.Scene control

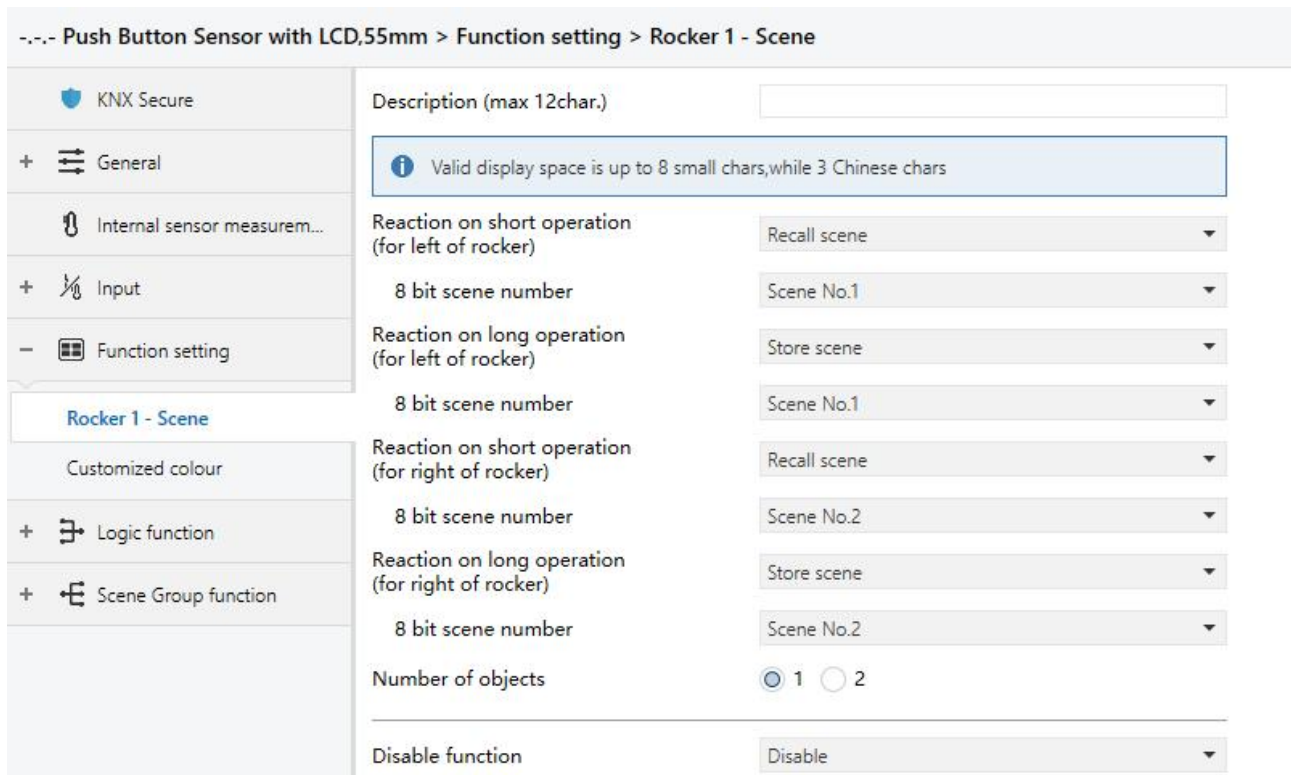

Fig.5.5.1.3(3) Parameter setting of dimming function

Parameter “Reaction on short operation (for left/right of rocker)”  
 Parameter “Reaction on long operation (for left/right of rocker)”

These two parameters are for setting to recall or storage scene for left/right of rocker buttons when long/short operation. Options:

**No reaction**

**Recall scene**

**Store scene**

—Parameter “8 bit scene number”

This parameter is visible when “No reaction” is not selected. Set the scene number. Options:

**Scene NO.1**

**Scene NO.2**

**Scene NO.3**

...

**Scene NO.64**

Corresponding telegram is 0~63

Parameter “Number of objects”

This parameter is for setting the number of objects when short/long operation. Options:

- 1
- 2

#### 4.Blind function

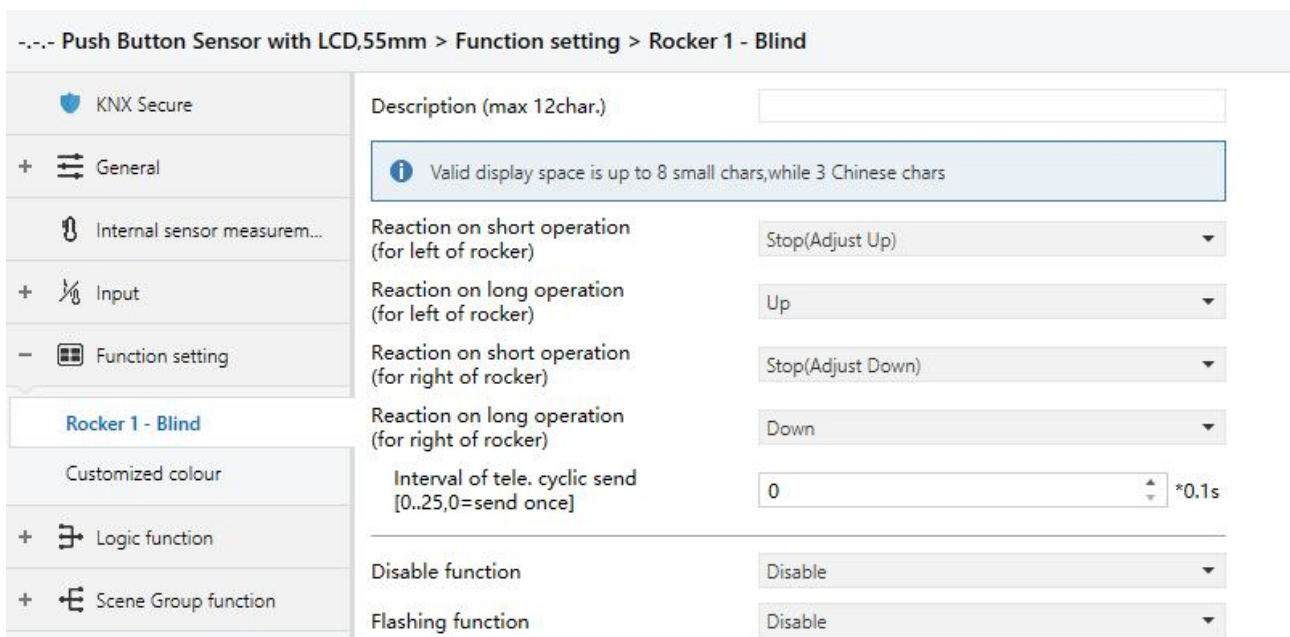

Fig.5.5.1.3(4) Parameter setting of blind function

Parameter “Reaction on short operation (for left/right of rocker)”

Parameter “Reaction on long operation (for left/right of rocker)”

These parameters are for setting the performed actions for left/right of rocker buttons when long/short operation. The object value is updated when the input is determined. Options:

- No reaction**
- Up**
- Down**
- Up/Down**
- Stop(Adjust Up)**
- Stop(Adjust Down)**
- Stop(Adjust Up/Down)**

No action: no action is performed.

Up: the curtains/blinds will be opened or moved up.

Down: the curtains/blinds will be closed or moved down.

Up/Down: alternately open/close or move up/down the curtains/blinds.

Stop (Adjust Up): stop the curtain movement or move up the angle of blinds.

Stop (Adjust Down): stop the curtain movement or move down the angle of blinds.

Stop (Adjust Up/Down): stop the curtain movement or move up/down the angle of blinds alternately.

—Parameter “ Interval of tele. cyclic send [0..25,0=send once]\*0.1s ”

This parameter is for setting the time interval of cyclical blinds angle adjustment telegram sent. Options:

**0..25,0=send once**

## 5.Setpoint adjustment

Fig.5.5.1.3(5) Parameter setting of setpoint adjustment

### Parameter “Reaction on operation”

This parameter is for setting the adjustment type of setpoint temperature. Options:

**Setpoint adjustment(absolute)**

**Offset Increase/Decrease(relative)**

**Offset setpoint adjustment(relative)**

Setpoint adjustment(absolute): apply to absolute adjust the setpoint temperature;

Offset Increase/Decrease(relative): apply to relative adjust the offset of setpoint temperature via 1 bit object;

Offset setpoint adjustment(relative): apply to relative adjust the offset of setpoint temperature.

## Parameter "Rocker operation mode"

This parameter is for setting the operation mode of rocker button. Options:

**Increase/Decrease**

**Decrease/Increase**

Increase/Decrease: the left of rocker button to increase setpoint temperature, and the right to decrease setpoint temperature;

Decrease/Increase: the left of rocker button to decrease setpoint temperature, and the right to increase setpoint temperature.

## Parameter "Setpoint adjustment step"

This parameter is visible when the setpoint temperature adjustment is selected "Setpoint adjustment (absolute)" or "Offset setpoint adjustment (relative)". Set the step value of setpoint adjustment. Options:

**0.5K**

**1K**

For absolute adjustment, if current setpoint temperature is 21°C, increase 0.5°C, then the current setpoint temperature is change to 21.5°C and sent to the bus; while decrease 0.5°C, then the current setpoint temperature is change to 20.5°C and sent to the bus.

For relative adjustment, if step value is 1K, current offset is 0K, increase per time to send 1K offset to the bus, if current offset is -1K, decrease per time to send -2K offset to the bus.

**Parameters as follow are visible when the setpoint temperature adjustment is selected "Setpoint adjustment (absolute)":**

## Parameter "Initial value when no response in startup"

This parameter is for setting the initial value of setpoint temperature after voltage recovery or download completion, that is, the used initial value when no response received in startup. Options:

**5°C**

**6°C**

**...**

**37°C**



Parameter “Min./Max. setpoint temperature”

These two parameters are for setting the adjustable range of the setpoint temperature. Options:

- 5°C
- 6°C
- ...
- 37°C

If the setpoint temperature beyond the limited range, it will output the limited temperature.

**For setpoint temperature, the Min. value must less than the Max., if not, it can not be modified on ETS.**

**Parameters as follow are visible when the setpoint temperature adjustment is selected “Offset setpoint adjustment (relative)”:**

Parameter “Initial value when no response in startup (K)”

This parameter is for setting the initial value of setpoint temperature offset after voltage recovery or download completion, that is, the used initial value when no response received in startup. Options: **-10..10**

Parameter “Min. setpoint offset [-10..0]K”

This parameter is for setting the maximum offset when setpoint temperature offset decrease (negative offset).

Options: **-10..0**

Parameter “Max. setpoint offset [0..10]K”

This parameter is for setting the maximum offset when setpoint temperature offset increase (forward offset).

Options: **0..10**

**For the offset, the Min. value and the Max. Value cannot be equal to 0 at the same time, if not, they can not be modified on ETS, and display red box warning, as shown as follow:**

Min. setpoint offset [-10..0]	<input type="text" value="0"/>	K
Max. setpoint offset [0..10]	<input style="border: 2px solid red;" type="text" value="0"/>	K

5.5.1.4. Status indication of rocker button

**Left/Right field display**

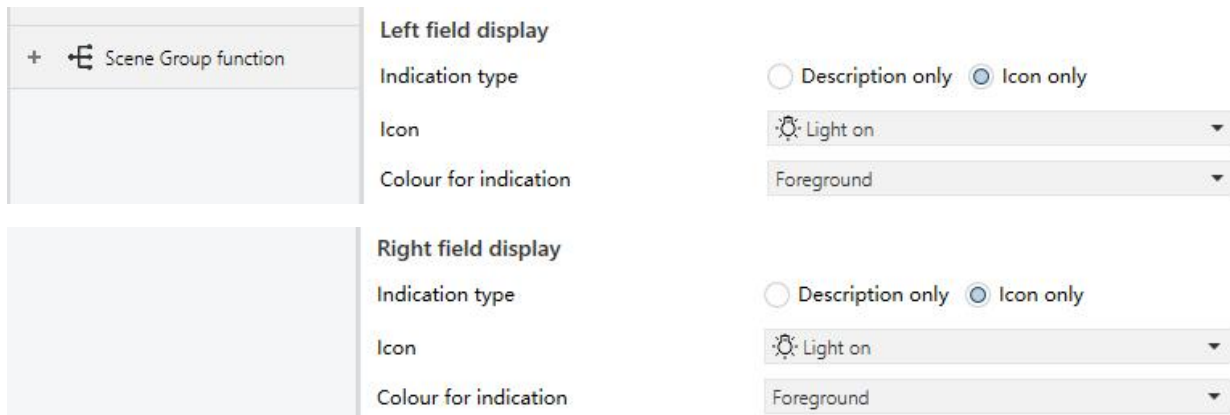

Fig.5.5.1.4(1) Parameter setting of left/right field display

**Parameter "Indication type"**

This parameter is for setting the indication type for left/right field of rocker buttons. Options:

**Description only**

**Icon only**

**Parameter "Description (max 7char.)"**

This parameter is for setting the description for for left/right field of rocker buttons, up to input 7 characters.

**Parameter "Icon"**

This parameter is visible when indication type is selected "Icon only". Set the icon of status indication.

Options:

**Light on**

**Light off**

...

**PM10**

The default icons corresponding to the function and the icons corresponding to the options are described in chapter 8.1.

**Parameter "Colour for indication"**

This parameter is for setting the colour of status indication. Options:

**Foreground**

**Cyan blue**

- |                   |                            |
|-------------------|----------------------------|
| <b>Red</b>        | <b>Cyan</b>                |
| <b>Dark green</b> | <b>Coffee</b>              |
| <b>Blue</b>       | <b>Light orange</b>        |
| <b>Yellow</b>     | <b>Customized colour 1</b> |
| <b>Orange</b>     | <b>Customized colour 2</b> |
| <b>Purple</b>     | <b>Customized colour 3</b> |
| <b>Grey</b>       | <b>Customized colour 4</b> |
| <b>Pink</b>       | <b>Customized colour 5</b> |

### Middle field display

	<b>Middle field display</b> Status indication: Via button switch status object Indication type: Icon + Description of button Icon for object value=1: Light on Colour for object value=1: Orange Icon for object value=0: Light off Colour for object value=0: Foreground
--	---

Via button switch status object

	<b>Middle field display</b> Status indication: Via external status object 1 bit Indication type: Icon + Description of button Icon for object value=1: Light on Colour for object value=1: Orange Icon for object value=0: Light off Colour for object value=0: Foreground
--	--

Via external status object 1 bit

+ Input - Function setting <b>Rocker 1 - Dimming</b> Customized colour + Logic function + Scene Group function	<b>Middle field display</b> Status indication: Via external status object 1 byte Indication type: Icon+status value Object datatype: <input type="radio"/> 1byte[0..255] <input checked="" type="radio"/> 1byte[0..100%] Threshold compare type: <input checked="" type="radio"/> Between the threshold value <input type="radio"/> Equal to the threshold value Number of threshold: 2 Threshold value 1 is: 0 % Threshold value 2 is: 20 %
---	---

Via external status object 1 byte(1)

	<p><b>If object value &lt;= threshold value 1</b></p> <p>Icon is <input type="text" value="Light on"/></p> <p>Colour is <input type="text" value="Foreground"/></p> <p><b>If threshold value 1 &lt; object value &lt;= threshold value 2</b></p> <p>Icon is <input type="text" value="Light on"/></p> <p>Colour is <input type="text" value="Red"/></p> <p><b>If object value &gt; threshold value 2</b></p> <p>Icon is <input type="text" value="Light on"/></p> <p>Colour is <input type="text" value="Dark green"/></p>
	<p>Via external status object 1 byte(2)</p> <p><b>Middle field display</b></p> <p>Status indication <input type="text" value="Via external status object 2 byte"/></p> <p>Indication type <input type="text" value="Icon+status value"/></p> <p>Icon for indication <input type="text" value="Light on"/></p> <p>Colour for indication <input type="text" value="Foreground"/></p>
	<p>Via external status object 2 byte</p> <p><b>Middle field display</b></p> <p>Status indication <input type="text" value="Via external status object 2 byte float"/></p> <p>Indication type <input type="text" value="Icon+status value"/></p> <p>Temperature display units <input type="text" value="Celsius(°C)"/></p> <p>Icon for indication <input type="text" value="Light on"/></p> <p>Colour for indication <input type="text" value="Foreground"/></p>
	<p>Via external status object 2 byte float</p> <p><b>Middle field display</b></p> <p>Status indication <input type="text" value="Always"/></p> <p>Indication type <input type="text" value="Icon + Description of button"/></p> <p>Icon for indication <input type="text" value="Light on"/></p> <p>Colour for indication <input type="text" value="Foreground"/></p>
	<p>Always</p>

Fig.5.5.1.4(2) Parameter setting of middle field display

**Parameter "Status indication"**

This parameter is for setting the status indication of button.

When button function is switch, options:

**Via button switch status object**

**Via external status object 1 bit**

**Via external status object 1 byte**

**Always**

When button function is selected scene control or blind, there is no **Via button switch status object** in the

above options;

When button function is selected dimming, in addition to the above options you can also select **Via external status object 2 byte**;

When button function is selected setpoint adjustment, options:

**Via external status object 1 bit**

**Via external status object 2 byte float**

**Always**

Via button switch status object: indicate the status via the value feed back form the switch status object;

Via external status object 1 bit: indicate the status via the value feed back form the 1 bit external object;

Via external status object 1 byte: indicate the status via comparing the value feed back form the 1 byte external object to the threshold value;

Via external status object 2 byte: display the received integer value, such as colour temperature;

Via external status object 2 byte float: display the received float value, such as temperature;

Always: always indicate in the same status.

#### Parameter "Indication type"

This parameter is for setting the indication type of button. Options:

**Description of button**

**Icon only**

**Icon + Description of button**

**Status value**

**Icon+status value**

**Int.temp + status value**

When button function is selected switch or scene control, there are no option about status, that is, the options have no "Status value" and "...status value";

When button function is selected dimming or blind, not support to the option "Int.temp + status value", and the options have no "Status value" and "...status value" when status indication is selected "Via button switch status object", "Via external status object 1 bit" or "Always";

When button function is selected setpoint adjustment, there are no option about status when status indication is selected "Via external status object 1 bit" or "Always", that is, the options have no "Status value" and "...status value"; While "Via external status object 2 byte float" is selected, only support to the options about status.

Parameters as follow are visible when status indication is selected “Via button switch status object” or “External status object 1 bit”:

Parameter “Icon for object value=1”

Parameter “Icon for object value=0”

These two parameters are visible when indication type is selected “Icon...”. Set the icon for object value=1 or value =0. Options:

**Light on**

**Light off**

...

**PM10**

The default icons corresponding to the function and the icons corresponding to the options are described in chapter 8.1.

Parameter “Colour for object value=1”

Parameter “Colour for object value=0”

These two parameters are for setting the colour of icon and text when status object telegram value is 1 or 0.

Options:

<b>Foreground</b>	<b>Cyan blue</b>
<b>Red</b>	<b>Cyan</b>
<b>Dark green</b>	<b>Coffee</b>
<b>Blue</b>	<b>Light orange</b>
<b>Yellow</b>	<b>Customized colour 1</b>
<b>Orange</b>	<b>Customized colour 2</b>
<b>Purple</b>	<b>Customized colour 3</b>
<b>Grey</b>	<b>Customized colour 4</b>
<b>Pink</b>	<b>Customized colour 5</b>

Parameters as follow are visible when status indication is selected “Via external status object 1 byte”:

Parameter “Object datatype”

This parameter is for setting the object datatype of status indication. Options:

**1byte[0..255]**

**1byte[0..100%]**

Parameter “Threshold compare type”

This parameter is for setting the threshold compare type, you can select to display when between the threshold value, or equal to the threshold value. Options:

**Between the threshold value**

**Equal to the threshold value**

Parameter “Threshold compare type”

This parameter is for setting the number of threshold compare.

When “Between the threshold value” is selected, options: **1 / 2 / 3 / 4**

When “Equal to the threshold value” is selected, options: **1 / 2 / 3 / 4 / 5**

Parameter “Threshold value x is” (x=1-5)

This parameter is for setting threshold value, status indication is via comparing between input value and threshold value.

Options display according to the object datatype: **0..255 / 0..100**

According to the threshold compare type and the number of threshold compare, you can set the icon and colour to display which match the threshold compare. Parameters as follow:

—Parameter “Icon is”

This parameter is visible when indication type is selected “Icon...”. Set the icon to display which matches the threshold compare. Options:

**Light on**

**Light off**

...

**PM10**

The default icons corresponding to the function and the icons corresponding to the options are described in

chapter 8.1.

—Parameter “Colour is”

This parameter is for setting the colour of icon and text which matches the threshold compare. Options:

<b>Foreground</b>	<b>Cyan blue</b>
<b>Red</b>	<b>Cyan</b>
<b>Dark green</b>	<b>Coffee</b>
<b>Blue</b>	<b>Light orange</b>
<b>Yellow</b>	<b>Customized colour 1</b>
<b>Orange</b>	<b>Customized colour 2</b>
<b>Purple</b>	<b>Customized colour 3</b>
<b>Grey</b>	<b>Customized colour 4</b>
<b>Pink</b>	<b>Customized colour 5</b>

**Parameters as follow are visible when status indication is selected “Via external status object 2 byte float”:**

**Parameter “Temperature display units”**

This parameter is for setting the temperature unit displayed on the screen, and the object datatype is all DPT 9.001 temperature. Options:

- Celsius(°C)**
- Fahrenheit(°F)**
- Kelvins(K)**

The temperature accuracy is to 0.1 on the screen, specific effect please refer to UI description.

**Parameters as follow are visible when status indication is selected “Via external status object 2 byte...” or “Always”:**

**Parameter “Icon for indication”**

This parameter is visible when indication type is selected “Icon...”. Set the icon to display for status indication. Options:

- Light on**



**Light off**

...

**PM10**

The default icons corresponding to the function and the icons corresponding to the options are described in chapter 8.1.

**Parameter "Colour for indication"**

This parameter is for setting the colour for status indication. Options:

<b>Foreground</b>	<b>Cyan blue</b>
<b>Red</b>	<b>Cyan</b>
<b>Dark green</b>	<b>Coffee</b>
<b>Blue</b>	<b>Light orange</b>
<b>Yellow</b>	<b>Customized colour 1</b>
<b>Orange</b>	<b>Customized colour 2</b>
<b>Purple</b>	<b>Customized colour 3</b>
<b>Grey</b>	<b>Customized colour 4</b>
<b>Pink</b>	<b>Customized colour 5</b>

### 5.5.1.5. Parameter window “Customized colour”

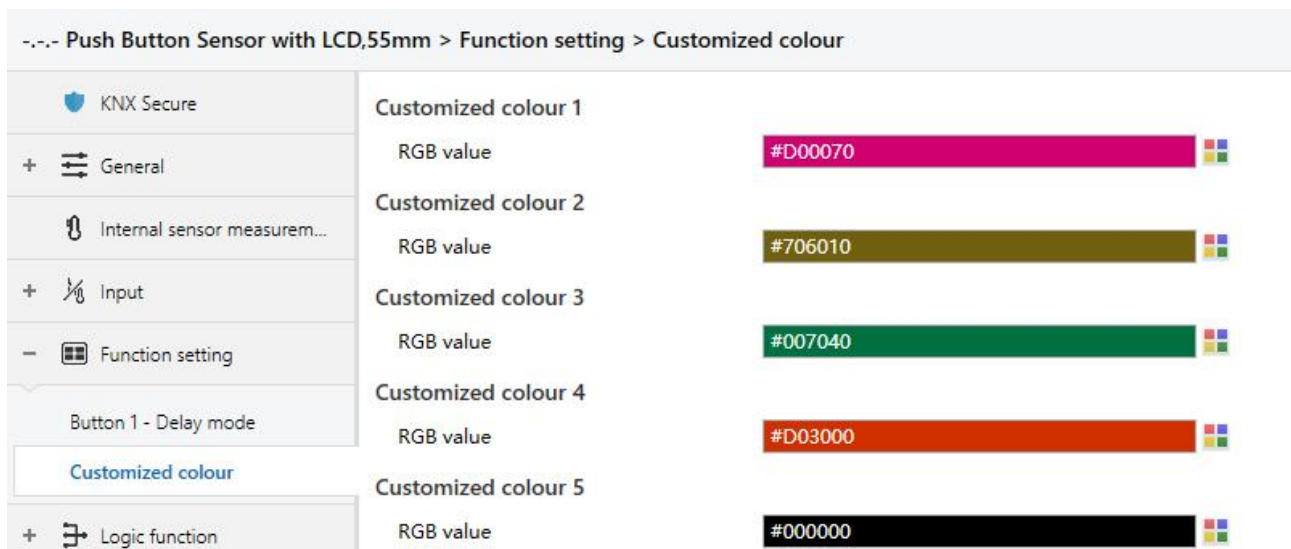

Fig.5.5.1.5 “Customized colour”parameter window

#### Customized colour x (x=1~5)

##### Parameter “RGB value”

This parameter is for setting the customized colour of status indication, user up to define 5 colours.

Options: **#000000** ....**#FFFFFF**

**5.5.2.Parameter window “Multifunction thermostat”**

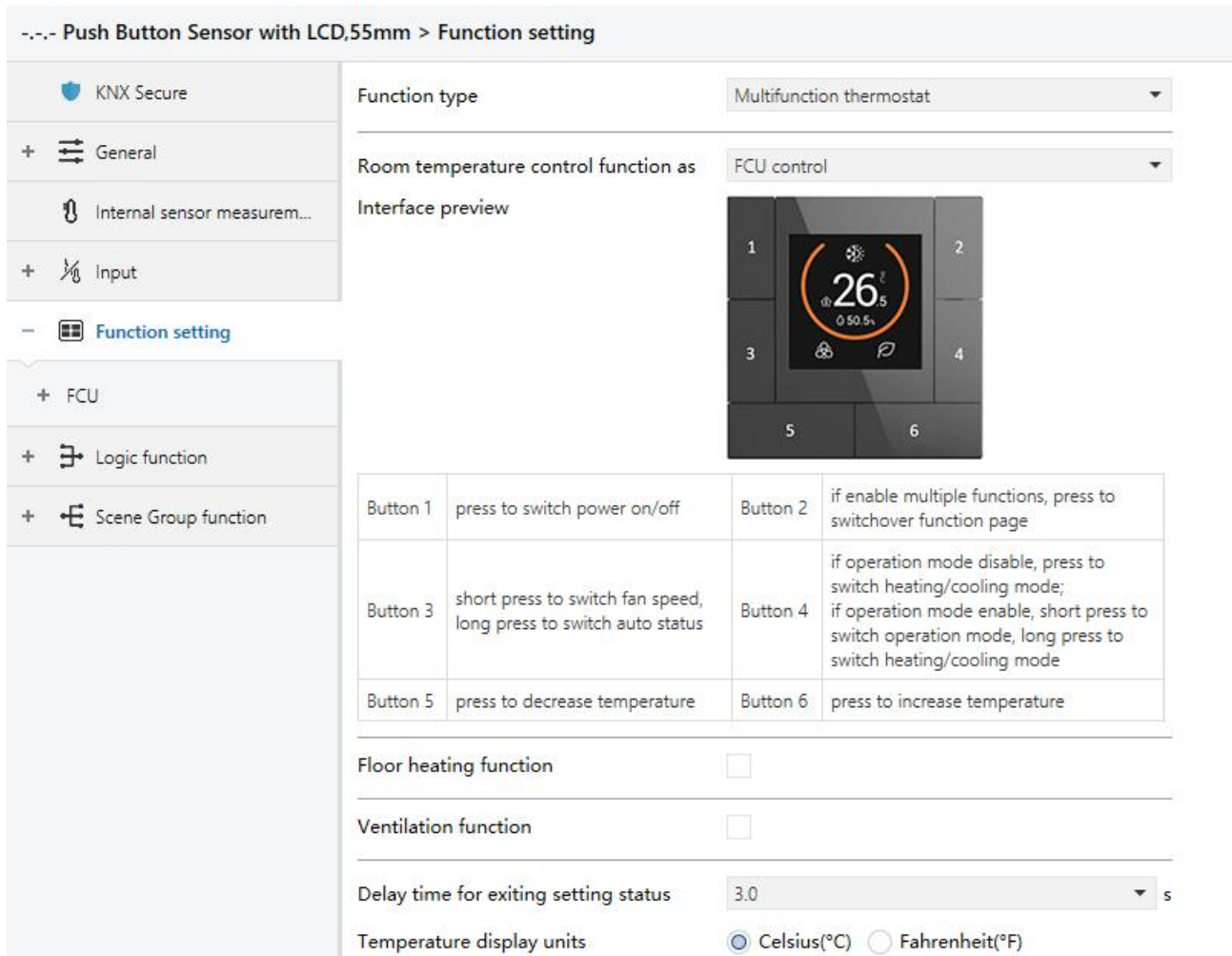

Fig.5.5.2 “Function setting”-“Multifunction thermostat” parameter window

**Parameter “Room temperature control function as”**

This parameter is for setting whether to enable the setting interface of room temperature control function, FCU control and VRF control can only choose one of them, select to display corresponding interface. Options:

**Disable**

**FCU control**

**VRF control**

**Parameter “Floor heating function”**

This parameter is for setting whether to enable the setting interface of floor heating function, select to display corresponding interface.

Parameter "Ventilation function"

This parameter is for setting whether to enable the setting interface of ventilation function, select to display corresponding interface.

Parameter "Delay time for exiting setting status"

This parameter is for setting the delay time to auto-exit setting status, mainly used for the sub function settings of RTC, floor heating and ventilation. Telegrams are sent immediately, such as setpoint temperature, specific definition is according to the UI. Options:

**0.5s**

**1.0s**

**2.0s**

**3.0s**

When Room temperature control function, Floor heating function and Ventilation function are enabled, this window displays the corresponding button operation, specific UI please refer to chapter 7.2.

5.5.2.1. Parameter window “FCU setting”

--- Push Button Sensor with LCD,55mm > Function setting > FCU

<ul style="list-style-type: none"> <li> KNX Secure</li> <li>+  General</li> <li> Internal sensor measurement...</li> <li>+  Input</li> <li>-  Function setting</li> <li style="background-color: #e0e0e0;">- <b>FCU</b></li> <li style="background-color: #e0e0e0;">Setpoint</li> <li style="background-color: #e0e0e0;">Heating/Cooling control</li> <li style="background-color: #e0e0e0;">Fan</li> <li style="background-color: #e0e0e0;">Scene</li> <li>+  Logic function</li> <li>+  Scene Group function</li> </ul>	<p>Indication function icon <input checked="" type="checkbox"/></p> <p>Icon <span style="border: 1px solid #ccc; padding: 2px;">Temperature</span></p> <p>Interface display internal humidity <input checked="" type="checkbox"/></p> <hr/> <p>Work mode <span style="border: 1px solid #ccc; padding: 2px;">Master</span></p> <p>Room temperature reference from <span style="border: 1px solid #ccc; padding: 2px;">Internal and External sensor combination</span></p> <p>Combination ratio <span style="border: 1px solid #ccc; padding: 2px;">50% Internal to 50% External</span></p> <p>Period for request external sensor [0..255] <span style="border: 1px solid #ccc; padding: 2px;">5</span> min</p> <p>Send temperature when the result change by <span style="border: 1px solid #ccc; padding: 2px;">1.0K</span></p> <p>Cyclically send temperature [0..255,0=inactive] <span style="border: 1px solid #ccc; padding: 2px;">0</span> min</p> <p>Control value after temp. error [0..100] (If 2-point control, set value '0'=0, set value '&gt;0'=1) <span style="border: 1px solid #ccc; padding: 2px;">0</span> %</p> <hr/> <p>Interface display temperature   <input type="radio"/> Setpoint temperature   <input checked="" type="radio"/> Actual temperature</p> <p>Setpoint temperature adjustment step   <input checked="" type="radio"/> 0.5K <input type="radio"/> 1K</p> <p>Min. setpoint temperature [5..37] <span style="border: 1px solid #ccc; padding: 2px;">16</span> °C</p> <p>Max. setpoint temperature [5..37] <span style="border: 1px solid #ccc; padding: 2px;">32</span> °C</p> <hr/> <p>Power on/off function <span style="border: 1px solid #ccc; padding: 2px;">Via both button and object</span></p> <p>Power on/off status after download   <input type="radio"/> OFF <input checked="" type="radio"/> ON</p> <p>Power on/off status after voltage recovery <span style="border: 1px solid #ccc; padding: 2px;">As before voltage failure</span></p> <hr/> <p>Room temperature control mode <span style="border: 1px solid #ccc; padding: 2px;">Heating and Cooling</span></p> <p>Heating/Cooling switchover <span style="border: 1px solid #ccc; padding: 2px;">Via both button and object</span></p> <p>Heating/Cooling status after download   <input checked="" type="radio"/> Heating <input type="radio"/> Cooling</p> <p>Heating/Cooling status after voltage recovery <span style="border: 1px solid #ccc; padding: 2px;">As before voltage failure</span></p> <p>Room temperature control system   <input type="radio"/> 2 pipes system <input checked="" type="radio"/> 4 pipes system</p> <hr/> <p>Room temperature operation mode <input checked="" type="checkbox"/></p> <p>Controller status after download <span style="border: 1px solid #ccc; padding: 2px;">Standby mode</span></p> <p>Controller status after voltage recovery <span style="border: 1px solid #ccc; padding: 2px;">As before voltage failure</span></p> <p>Extended comfort mode [0..255,0=inactive] <span style="border: 1px solid #ccc; padding: 2px;">0</span> min</p> <p>1 bit object function for operation mode <input checked="" type="checkbox"/></p> <p>1 bit object for standby mode <input checked="" type="checkbox"/></p>
---	--

Fig.5.5.2.1(1) “FCU setting” parameter window

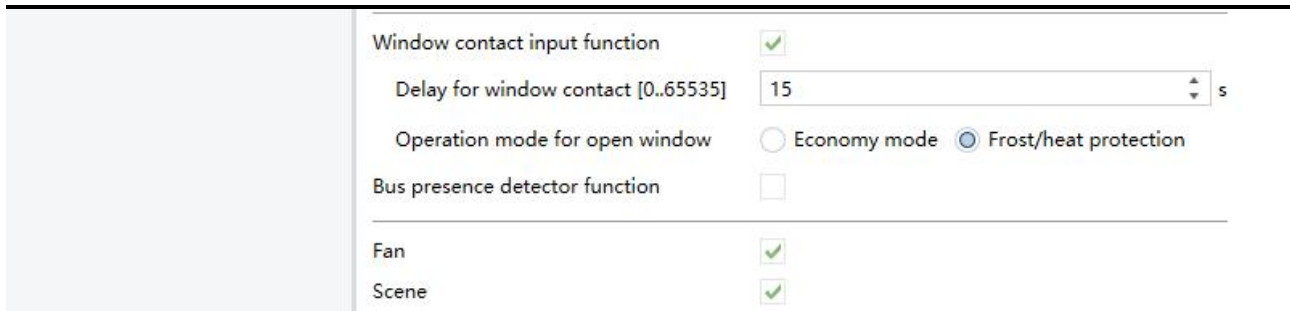

Fig.5.5.2.1(2) “FCU setting” parameter window

**Parameter “Indication function icon”**

This parameter is for setting whether to display the icon of FUC control on the screen.

When enabled, parameter as follow is visible:

— **Parameter “Icon”**

This parameter is for setting the function icon. Options:

**Air conditioner**

**Floor heating**

...

**Temperature**

The default icons corresponding to the function and the icons corresponding to the options are described in the appendix, please refer to chapter 8.2.

**Parameter “Interface display internal humidity”**

This parameter is for setting whether to display the internal humidity on the screen, the humidity is determined by the setting of the “Internal sensor measurement” in the parameter interface, more details refer to chapter 5.3.

**Parameter “Work mode”**

This parameter is for setting the work mode of FCU control. Options:

**Single**

**Master**

**Slave**

Single: FCU control of the device is set to single control and with a temperature control algorithm, the output directly controls the actuator;

Master: FCU control of the device is set to multi-control and with a temperature control algorithm, the output

is dominated by the device. When the device restarts, it sends the current status to the bus, such as power on/off, setpoint temperature, control mode, operation mode, and fan speed read request;

Slave: FCU control of the device is set to slave control, at this time FCU is only used as touch and display, no temperature control algorithm, when the device restarts, it will send the status read request, such as power on/off, setpoint temperature, control mode, operation mode, fan speed.

## Parameter “Room temperature reference from”

This parameter is for setting the resource of the room temperature reference. Options:

**Internal sensor**

**External sensor**

**Internal sensor combine with External sensor**

When selecting the reference internal sensor, the temperature is determined by the setting of the “Internal sensor measurement” in the parameter interface, more details refer to chapter 5.3.

## —Parameter “Period for request external sensor [0...255]min”

This parameter is visible when “...External sensor” is selected. Set the time period for read request external temperature sensor. Options: **0..255**

**Parameters as follow are visible when “Internal sensor combine with External sensor” is selected.**

## —Parameter “Combination ratio”

This parameter is for setting the internal sensor and the external sensor to measure the specific gravity of the temperature. Options:

**10% Internal to 90% External**

**20% Internal to 80% External**

...

**90% Internal to 10% External**

For example, if the option is “40% internal to 60% external”, then the internal sensor accounts for 40%, the external sensor accounts for 60%, and the control temperature = (internal sensor's temperature × 40%) + (external sensor's temperature × 60%), the RTC function of the device will control and display the temperature according to the calculated temperature.

When two sensors are combined for detection, when one sensor is in error, the temperature value detected by

the other sensor is used.

—Parameter “Send temperature when the result change by [0...10]K”

This parameter is for setting when temperature turns to a certain value, whether to enable to send the current temperature value to the bus. Not send when disable. Options:

**Disable**

**0.5K**

**1.0K**

...

**10.0K**

—Parameter “Cyclically send temperature [0...255,0=inactive]min”

Setting the time for cyclically sending the temperature detection value to the bus. Not send when value is 0.

Options: **0..255**

**Note: cyclically sending and change sending are independent of each other.**

Parameter “Control value after temp. error[0..100]% (if 2-point control, set value '0'=0, set value '>0'=1)”

When the work mode is “Slave”, this parameter is not visible.

Set the control value when temperature error occur. Options: **0..100**

If 2-Point control, then the parameter value is 0, as well as the control value; if the parameter value is more than 0, then the control value will be 1.

Parameter “Interface display temperature”

This parameter is for setting the interface display temperature under the normal status. Options:

**Setpoint temperature**

**Actual temperature**

If display actual temperature, it just to wake up when firstly adjust setpoint temperature, and not send telegram.

Parameter “Setpoint temperature adjustment step”

This parameter is for setting the step value of setpoint temperature. Options:

**0.5K**

**1K**



Parameter "Min./Max. setpoint temperature [5..37] ° C"

These parameters are for setting the adjustable range of the setpoint temperature. The minimum value should be less than the maximum value. Options:

**5°C**

**6°C**

...

**37°C**

If the setpoint temperature beyond the limited range, it will output the limited temperature.

**For setpoint temperature, the Min. value must less than the Max., if not, it can not be modified on ETS.**

Parameter "Power on/off function "

This parameter is for setting whether to enable power on/off function of controller. Options:

**Disable**

**Via button only**

**Via object only**

**Via both button and object**

Disable: power on/off function of controller is disabled;

Via button only: control power on/off only via the panel button;

Via object only: control power on/off only via the object;

Via both button and object: control power on/off both via the panel button and object.

These two parameter as follow and objects are visible when enabled:

Parameter "Power on/off status after download "

When the work mode is "Slave", this parameter is not visible.

Set the power on/off status of FCU control interface after download. Options:

**OFF**

**ON**

Parameter "Power on/off status after voltage recovery"

When the work mode is "Slave", this parameter is not visible.

Set the power on/off status of FCU control interface after device voltage recovery. Options:

**OFF**

**ON**

**As before voltage failure**

OFF: FCU control interface is off when device is powered on, this interface is not operational, and FCU is not running;

ON: FCU control interface is on when device is powered on, this interface is operational, FCU will calculate internally according to the control type to determine the current controlling status;

As before voltage failure: FCU control interface will recover to the status before voltage failure, if it is on, then FCU will calculate internally according to the control type to determine the current controlling status.

#### Parameter “Room temperature control mode”

This parameter is for setting the room temperature control mode. Options:

**Heating**

**Cooling**

**Heating and Cooling**

Parameters as follow are visible when “Heating and Cooling” is selected.

#### —Parameter “Heating/Cooling switchover”

This parameter is for setting the switchover way of Heating/Cooling. Options:

**Only via button**

**Only via object**

**Via both button and object**

**Automatic changeover**

When the work mode is “Slave”, the option is only **Only via object**

#### —Parameter “Heating/Cooling status after download”

When the work mode is “Slave”, this parameter is not visible.

Set the heating/cooling control mode of device after download. Options:

**Heating**

**Cooling**

—Parameter “Heating/Cooling status after voltage recovery”

When the work mode is “Slave”, this parameter is not visible.

Set the heating/cooling control mode of device after voltage recovery. Options:

**Heating**

**Cooling**

**As before voltage failure**

As before voltage failure: the control mode will recover as before voltage failure after voltage recovery. If it is the first time the device is used or a newly enabled function page, the control mode after the device is started is in an uncertain state, and it needs to be manually selected at this time.

—Parameter “Room temperature control system”

When the work mode is “Slave”, this parameter is not visible.

Set the type of room temperature control system, that is, pipe types of fan coil water inlet/outlet. Options:

**2 pipes system**

**4 pipes system**

2 pipes system: shares an inlet and outlet pipe for heating and cooling, that is, both hot and cold water are controlled by a valve.

4 pipes system: has its own inlet and outlet pipes for heating and cooling, and two valves are needed to control the entry and exit of hot water and cold water respectively.

Parameter “Room temperature operation mode”

This parameter is for setting whether to enable room temperature operation mode.

When enabled, support 4 modes with comfort, standby, economy and frost/heat protection. Support datatype of 1byte, and preset a operation mode when download and voltage recovery.

**Parameters as follow are visible when operation mode is enabled.**

—Parameter “Controller status after download”

When the work mode is “Slave”, this parameter is not visible.

Set the operation mode when power on FCU after download. Options:

**Comfort mode**

**Standby mode**

**Economy mode**

— **Parameter “Controller status after voltage recovery”**

When the work mode is “Slave”, this parameter is not visible.

Set the operation mode when power on FCU after voltage recovery. Options:

**Comfort mode**

**Standby mode**

**Economy mode**

**Frost/heat protection**

**As before voltage failure**

— **Parameter “Extended comfort mode [0..255,0=inactive]min”**

When the work mode is “Slave”, this parameter is not visible.

Set the extended time of comfort mode. When value >0, activate the extended, and 1 bit object “Extended comfort mode” is visible. Options: **0..255**

When object receives telegram 1, comfort mode is activated. If receive telegram 1 again during the delay time, the time is retiming. And comfort mode will return to previous operation mode once finish the timing. Exit the comfort mode when a new operation mode in delay time.

Change the operation mode will quit the timing, and heating/cooling switchover will not.

— **Parameter “1 bit object function for operation mode”**

When the work mode is “Master”, this parameter is visible.

Set whether to enable 1 bit object function for operation mode.

When enabled, the 1 bit object function for operation mode is visible, send telegram 1 to activate corresponding mode.

If receive the telegram 0 of comfort, economy and protection mode from the bus, current mode will be updated to standby mode.

— **Parameter “1 bit object for standby mode”**

This parameter is visible when previous parameter is enabled. Set whether to enable 1 bit object for standby mode.

When enabled, the 1 bit object function for standby mode is visible.

**Parameters as follow are visible when operation mode is disabled.**

—Parameter “Initial setpoint temperature (° C)”

When the work mode is “Slave”, this parameter is not visible.

Set the initial value of setpoint temperature. Options:

**10.0**

**10.5**

...

**35.0**

When initial setpoint temperature is less than the min. setpoint temperature, display following warning:

 The setpoint is less than minimum,so minimum will regard as setpoint in fact

When initial setpoint temperature is greater than the max. setpoint temperature, display following warning:

 The setpoint is greater than maximum,so maximum will regard as setpoint in fact

**Automatic H/C mode changeover dead zone**

—Parameter “Upper/Lower dead zone”

When the work mode is “Slave”, these two parameters are not visible.

These two parameters are visible when control mode is selected “Heating and Cooling”, and “Automatic changeover” is selected. Setting the dead zone range of auto switchover heating/cooling. Options:

**0.5K**

**1.0K**

...

**10.0K**

Under heating control, when the actual temperature(T) greater than or equal to the setpoint temperature + the upper dead zone, then mode heating switch to cooling;

Under cooling control, when the actual temperature(T) less than or equal to the setpoint temperature + the upper dead zone, then mode cooling switch to heating.

#### Parameter “Window contact input function”

When the work mode is “Slave”, this parameters is not visible.

This parameter is visible when operation mode is enabled. Set whether to link to window contact status.

When window contact input function is enabled, these two parameters as follow are visible:

—Parameter “Delay for window contact [0..65535]s”

This parameter is visible when operation mode and window contact input function are enabled. Set the delay time to window contact detection. That is, when receive a telegram “window open”, the controller will regard that as a valid signal and execute the behaviour after this delay time. Options: **0..65535**

—Parameter “Controller mode for open window”

If window status is open, perform corresponding operation according to configuration. (For the operation mode, the Switch and Setpoint temperature, as well as Heating/Cooling mode are recorded in the background if control telegrams are received, and performed after the window is closed. If there is no telegram receiving during timing, return to the mode before the window was opened.) Options:

**Economy mode**

**Frost/heat protection**

#### Parameter “Bus presence detector function”

When the work mode is “Slave”, this parameter is not visible.

This parameter is visible when operation mode is enabled. Set whether to link to bus presence detector status.

If presence is detected, enter the comfort mode and it will be restored to original mode after leaving. If there is a telegram/manual operation to adjust the mode during the period, the telegram is logged in the background, and it will be exited comfort mode and restored to the mode after leaving. If there is no telegram receiving during timing, return to original mode. (If receive the presence status cyclically, comfort mode can not be re-triggered, and only can be after leaving.)

#### Parameter “Fan”

This parameter is for setting whether to enable fan control interface is visible.

#### Parameter “Scene”

When the work mode is “Slave”, this parameter is not visible.

Set whether to enable scene function is visible. When enabled, link to power on/off, operation mode, setpoint temperature.

5.5.2.1.1.Parameter window “Setpoint”

--- Push Button Sensor with LCD,55mm > Function setting > FCU > Setpoint

<ul style="list-style-type: none"> <li>KNX Secure</li> <li>General</li> <li>Internal sensor measurem...</li> <li>Input</li> <li>Function setting</li> <li>FCU <ul style="list-style-type: none"> <li><b>Setpoint</b></li> <li>Heating/Cooling control</li> <li>Fan</li> <li>Scene</li> </ul> </li> <li>Logic function</li> <li>Scene Group function</li> </ul>	<p>Setpoint method for operating mode <input checked="" type="radio"/> Relative <input type="radio"/> Absolute</p> <p>Base setpoint temperature 20.0 °C</p> <p><b>Automatic H/C mode changeover dead zone (only for comfort mode)</b></p> <p>Upper dead zone 2.0 K</p> <p>Lower dead zone 2.0 K</p> <p><b>Heating</b></p> <p>Reduced heating in standby mode [0..10] 2 K</p> <p>Reduced heating in economy mode [0..10] 4 K</p> <p>Setpoint temperature in frost protection [5..10] 7 °C</p> <p><b>Cooling</b></p> <p>Increased cooling in standby mode [0..10] 2 K</p> <p>Increased cooling in economy mode [0..10] 4 K</p> <p>Setpoint temperature in heat protection [30..37] 35 °C</p> <p>Parameter setting of relative adjustment</p> <p>Setpoint method for operating mode <input type="radio"/> Relative <input checked="" type="radio"/> Absolute</p> <p><b>Heating</b></p> <p>Setpoint temperature in comfort mode [5..37] 21 °C</p> <p>Setpoint temperature in standby mode [5..37] 19 °C</p> <p>Setpoint temperature in economy mode [5..37] 17 °C</p> <p>Setpoint temperature in frost protection [5..10] 7 °C</p> <p><b>Cooling</b></p> <p>Setpoint temperature in comfort mode [5..37] 23 °C</p> <p>Setpoint temperature in standby mode [5..37] 25 °C</p> <p>Setpoint temperature in economy mode [5..37] 27 °C</p> <p>Setpoint temperature in heat protection [30..37] 35 °C</p> <p><b>Note:</b> The heating setpoint must be always less than the cooling setpoint.</p>
--	--

Parameter setting of absolute adjustment  
 Fig.5.5.2.1.1 “Setpoint” parameter window

When the work mode is “Slave”, this parameter window is not visible.

This parameter window is visible when operation mode is enabled, and display according to control mode.

Parameter "Setpoint method for operating mode"

This parameter is for setting the setpoint method for operating mode. Options:

**Relative**

**Absolute**

Relative: relative adjustment, the setpoint temperature of economy mode and standby mode will refer to the defined temperature setpoint.

Absolute: absolute adjustment, each mode has its independent temperature setpoint.

**Parameters as follow are visible when the setpoint temperature adopts the relative adjustment method.**

Parameter "Base setpoint temperature ( ° C)"

This parameter is for setting the base setpoint temperature, from which the setpoint temperature of the room comfort mode is obtained. Options:

**10.0**

**10.5**

...

**35.0**

The setpoint value will be modified through object "Base temperature setpoint, status", then the new value will be stored after the device power off.

When base setpoint temperature is less than the min. setpoint temperature, display following warning:

✘ The setpoint is less than minimum,so minimum will regard as setpoint in fact

When base setpoint temperature is greater than the max. setpoint temperature, display following warning:

✘ The setpoint is greater than maximum,so maximum will regard as setpoint in fact

**Automatic H/C mode changeover dead zone (only for comfort mode)**

Parameter "Upper/Lower dead zone"

These two parameters are visible when control mode "Heating and Cooling" and "Automatic changeover" are selected. Set the dead zone range of auto switchover heating/cooling. Options:

**0.5K**



**1.0K**

...

**10.0K**

Under heating control, when the actual temperature(T) > or = the setpoint temperature + the upper dead zone, then mode heating switch to cooling;

Under cooling control, when the actual temperature(T) < or = the setpoint temperature + the lower dead zone, then mode cooling switch to heating.

Parameter "Reduced heating in standby mode [0...10]K"

Parameter "Increased cooling in standby mode [0...10]K"

These two parameters are for setting the setpoint of standby mode. Options:

**0K**

**1K**

...

**10K**

Heating: the setpoint of standby mode is the temperature setpoint minus the reference value;

Cooling: the setpoint of standby mode is the temperature setpoint plus the reference value.

Parameter "Reduced heating in economy mode [0...10]K"

Parameter "Increased cooling in economy mode [0...10]K"

These two parameters are for setting the setpoint of economy mode. Options:

**0K**

**1K**

...

**10K**

Heating: the setpoint of economy mode is the temperature setpoint minus the reference value;

Cooling: the setpoint of economy mode is the temperature setpoint plus the reference value.

Parameter "Setpoint temperature in frost protection mode [5...10] ° C"

This parameter is for setting the setpoint of frost protection mode for Heating. Options:

**5°C**

**6°C**

...

**10°C**

Under the frost protection mode, when room temperature reduce to the setpoint, the controller will trigger a control telegram so that related heating controller will output heating control to prevent the temperature from being too low.

Parameter "Setpoint temperature in heat protection mode [30..37]° C"

This parameter is for setting the setpoint of heat protection mode for Cooling. Options:

**30°C**

**31°C**

...

**37°C**

Under the heat protection mode, when room temperature raise to the setpoint, the controller will trigger a control telegram so that related cooling controller will output cooling control to prevent the temperature from being too high.

**Parameters as follow are visible when the setpoint temperature adopts the absolute adjustment method.**

Parameter "Setpoint temperature in comfort mode [5..37]° C"

Parameter "Setpoint temperature in standby mode [5..37]° C"

Parameter "Setpoint temperature in economy mode [5..37]° C"

These parameters are for setting the setpoint temperature in comfort, standby and economy mode when heating or cooling. Options:

**5°C**

**6°C**

...

**37°C**

Parameter "Setpoint temperature in frost protection mode [5..10]° C"

This parameter is for setting the setpoint temperature in frost protection mode when heating. Options:

**5°C**

**6°C**

...

**10°C**

## Parameter "Setpoint temperature in heat protection mode [30..37]° C"

This parameter is for setting the setpoint temperature in heat protection mode when cooling. Options:

30°C

31°C

...

37°C

 Note: The heating setpoint must be always less than the cooling setpoint.

**For absolute adjustment mode, when "Heating and Cooling" is selected, whether it is manual changeover, either bus changeover or automatic changeover, the heating setpoint value must be less than or equal to the cooling of the same operation mode, if not, it can not be modified on ETS.**

1. When the ambient temperature is higher than the setpoint temperature of current mode in cooling, it is changed to cooling mode; When the ambient temperature is lower than the setpoint temperature of current mode in heating, it is changed to heating mode.

2. In the same operation mode, the setpoint temperature difference between cooling and heating remains constant, whether it is written on the bus or adjusted on the panel. That is, when adjust the setpoint temperature, it need to update cooling and heating setpoint temperature of current operation mode at the same time.

3. When user operates on the panel or the bus is received setpoint temperature, it is still necessary to limit the value according to the high and low thresholds, that is heating and cooling temperature neither can not be lower than the min., or can not be higher than the max.. If parameters configuration of ETS is not met the condition, it will be noted warnings:

When the setpoint temperature of comfort/standby/economy mode is less than the min. setpoint temperature, display following warning:

 The setpoint is less than minimum,so minimum will regard as setpoint in fact

When the setpoint temperature of comfort/standby/economy mode is greater than the max. setpoint temperature, display following warning:

 The setpoint is greater than maximum,so maximum will regard as setpoint in fact

**Note: for relative/absolute adjustment, in protection mode, the setpoint temperature is only configured via ETS, and not limited with the min./max. value, and user can not change it on screen via the button.**

5.5.2.1.2. Parameter window “Heating/Cooling control”

--- Push Button Sensor with LCD,55mm > Function setting > FCU > Heating/Cooling control

<ul style="list-style-type: none"> <li>KNX Secure</li> <li>+ General</li> <li>Internal sensor measurem...</li> <li>+ Input</li> <li>- Function setting             <ul style="list-style-type: none"> <li>- FCU                 <ul style="list-style-type: none"> <li>Setpoint</li> <li><b>Heating/Cooling control</b></li> <li>Fan</li> </ul> </li> </ul> </li> </ul>	Type of heating/cooling control	Switching on/off(use 2-point control)		
	Invert control value	<input type="checkbox"/>		
	<b>Heating</b>			
	Lower Hysteresis [0..200]	10		*0.1K
	Upper Hysteresis [0..200]	10		*0.1K
	<b>Cooling</b>			
	Lower Hysteresis [0..200]	10		*0.1K
	Upper Hysteresis [0..200]	10		*0.1K
	Cyclically send control value[0..255]	0		min
	Parameter setting of “Switching on/off(use 2-point control)”			
	Type of heating/cooling control	Switching PWM(use PI control)		
	Invert control value	<input type="checkbox"/>		
PWM cycle time [1..255]	15		min	
Heating speed	User defined			
Proportional range [10..100]	40		*0.1K	
Reset time [0..255]	150		min	
Cooling speed	User defined			
Proportional range [10..100]	40		*0.1K	
Reset time [0..255]	150		min	
Cyclically send control value[0..255]	0		min	
Parameter setting of “Switching PWM(use PI control)”				
Type of heating/cooling control	Continuous control(use PI control)			
Invert control value	<input type="checkbox"/>			
Heating speed	User defined			
Proportional range [10..100]	40		*0.1K	
Reset time [0..255]	150		min	
Cooling speed	User defined			
Proportional range [10..100]	40		*0.1K	
Reset time [0..255]	150		min	
Parameter setting of “Continuous control(use PI control)” (1)				



Parameter setting of “Continuous control(use PI control)” (2)  
 Fig.5.5.2.1.2(1) “Heating/Cooling control” parameter window

When the work mode is “Slave”, this parameter window is not visible.

This parameter window displays according to control mode and control system (2 pipe or 4pipe).

**Parameter “Type of heating/cooling control”**

This parameter is for setting the type of heating/cooling control. Different control types are suitable for controlling different temperature controllers. Options:

**Switching on/off(use 2-point control)**

**Switching PWM(use PI control)**

**Continuous control(use PI control)**

**Parameter “Invert control value”**

This parameter is for setting whether to invert control value or normal sending control value, so that the control value will be suitable for the valve type.

When enabled, send the control value to the bus through objects after inverting the control value.

**These two parameters as follow are suitable for 2 point control:**

**—Parameter “Lower Hysteresis [0...200]\*0.1K ”**

**—Parameter “Upper Hysteresis [0...200]\*0.1K ”**

These two parameters are for setting the lower/upper hysteresis temperature in FCU heating or cooling.

Options: **0..200**

**Under heating control,**

**When the actual temperature(T) > the setpoint temperature + the upper hysteresis temperature, then will stop heating;**

**When the actual temperature(T) < the setpoint temperature - the lower hysteresis temperature, then will start heating.**

For example, the lower hysteresis temperature is 1K, the upper hysteresis temperature is 2K, the setpoint temperature is 22°C, if T is higher than 24°C, then it will stop heating; if T is lower than 20°C, then it will start heating; if T is between 21~24°C, then it will maintain the previous status.

Under the cooling control,

When the actual temperature (T) < the setpoint temperature -the lower hysteresis temperature, then will stop cooling;

When the actual temperature (T) > the setpoint temperature +the upper hysteresis temperature, then will start cooling.

For example, the lower hysteresis temperature is 1K, the upper hysteresis temperature is 2K, the setpoint temperature is 26°C, if T is lower than 25°C, then it will stop cooling; if T is lower than 28°C, then it will start cooling; if T is between 28~25°C, then it will maintain the previous status.

**2-point control mode is a very simple control mode. When adopting this control mode, it is necessary to set the upper hysteresis temperature and the lower hysteresis temperature through parameters. When setting the hysteresis temperature, the following effects need to be considered**

1. When hysteresis interval is small, the temperature range will be small, however, frequent sending of control value will bring large load to the bus;
2. When hysteresis interval is large, the switch switching frequency will be low, but it is easy to cause uncomfortable temperature change.

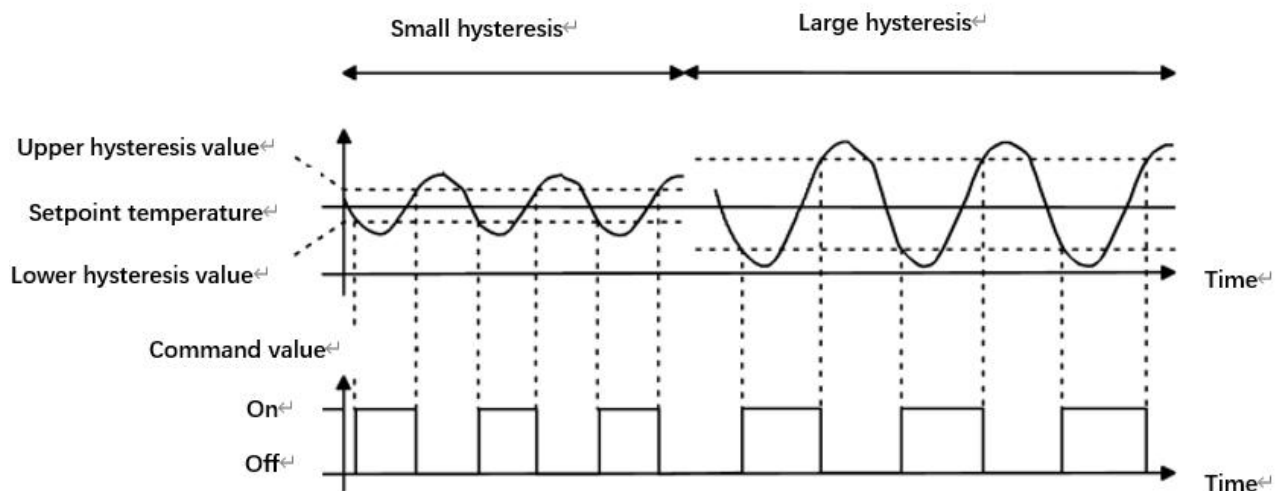

Fig.5.5.2.1.2(2) Effects of hysteresis on control value switch action(heating) under2-point control mode

**These two parameters as follow are suitable for PI control:**

—Parameter “PWM cycle time [1..255]min”

This parameter is only visible when the control type is “Switching PWM(use PI control)”. Set the period of the control object cycle to send the switch value, the object sends the switch value according to the duty cycle of the control value. For example, if the set period is 10 min and the control value is 80%, then the object will send an open telegram for 8 min. If the control value is changed, the time duty ratio of the on/ off telegram of the object will also change, but the period is still the time of parameter setting.

Options: **1..255**

The PI values of “Switching PWM (use PI control)” and “Continuous control (use PI control)” are the same, only different in control objects, the control object of “Continuous control” output PI value(1byte) directly, while the control value of “Switching PWM” output a “on/off” telegram according to the duty cycle of the control value.

—Parameter “Heating speed ”

—Parameter “Cooling speed”

These two parameters are for setting the responding speed of heating or cooling controller. Different responding speeds are suitable for different environments.

Options:

**Hot water heating (5K/150min)**

**Underfloor heating (5K/240 min)**

**Electrical heating (4K/100min)**

**Split unit (4K/90min)**

**Fan coil unit (4K/90min)**

**User defined**

Options:

**Cooling ceiling (5K/240min)**

**Split unit (4K/90min)**

**Fan coil unit(4K/90min)**

**User defined**

—Parameter “Proportional range [10..100]\*0.1K”(P value)

—Parameter “Reset time [0..255]min”(I value)

These two parameters are visible when “User defined” is selected. Set the PI value of PI controller.

Options: **10..100 (P value)**

Options: **0..255 (I value)**

—Parameter “Send control value on change by [0..100.0=inactive]”

This parameter is visible when control type is “Continuous control (use PI control)”, for setting the changing value of the control value to be sent to the bus. Options: **0..100, 0=inactive**

**In PI control mode, the predefined control parameters of each PI controller in heating or cooling system are recommended as follows:**

**(1)Heating**

Heating type	P value	I value(integration time)	Recommended PI control type	Recommended PWM period
Hot water Heating	5K	150min	Continuous/PWM	15min
Underfloor heating	5K	240min	PWM	15-20min
Electrical heating	4K	100min	PWM	10-15min
Split unit	4K	90min	PWM	10-15min
Fan coil unit	4K	90min	Continuous	--

**(2)Cooling**

Cooling type	P value	I value(integration time)	Recommended PI control type	Recommended PWM period
Cooling ceiling	5K	240min	PWM	15-20min
Split unit	4K	90min	PWM	10-15min
Fan coil unit	4K	90min	Continuous	--



**(3)User defined**

When the parameter“Heating/Cooling speed” is set to “User defined”, the parameter value of P (scale factor) and I (integration time) can be set through the parameter. When adjusting the parameters, refer to the fixed PI value mentioned in the above table. Even if the control parameters are adjusted slightly, the control behavior will be significantly different.

In addition, the integration time should be set properly. If the integration time is too long, the adjustment will be slow, and the oscillation will not be obvious; if the integration time is too small, the adjustment will be fast, but the oscillation will occur. 0 means the integral term is not used.

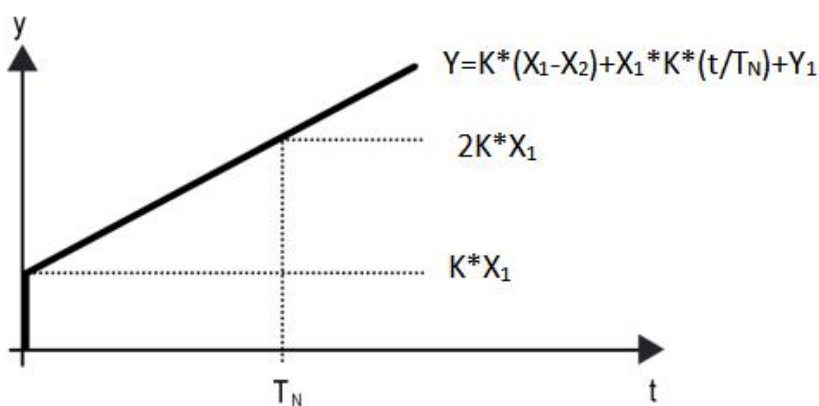

Fig.5.5.2.1.2(3) Control value of PI control mode

Y: control value

Y1: last control value

X1: temperature deviation = set temperature - actual temperature

X2: last temperature deviation = set temperature - actual temperature

T<sub>N</sub>: integration time

K: scale factor (the scale factor is not zero)

PI control algorithm:  $Y = K * (X1-X2) + X1 * K * t / T_N + Y1$

When the integration time is set to zero, the PI control algorithm is:  $Y = K (X1-X2) + Y2$

**Setting and influence of user-defined parameters:**

Parameter setting	Effect
K: If the scale range is too small	Quick adjustment, and overshoot will occur
K: If the scale range is too small	Slow adjustment, but no overshoot
T <sub>N</sub> : If the integration time is too short	Quick adjustment, but there will be oscillation
T <sub>N</sub> : If the integration time is too long	Slow adjustment, no obvious oscillation

Parameter "Cyclically send control value {0..255}min"

This parameter is for setting the period for cyclically sending the control value to the bus. Options: **0..255**

5.5.2.1.3.Parameter window “Fan”

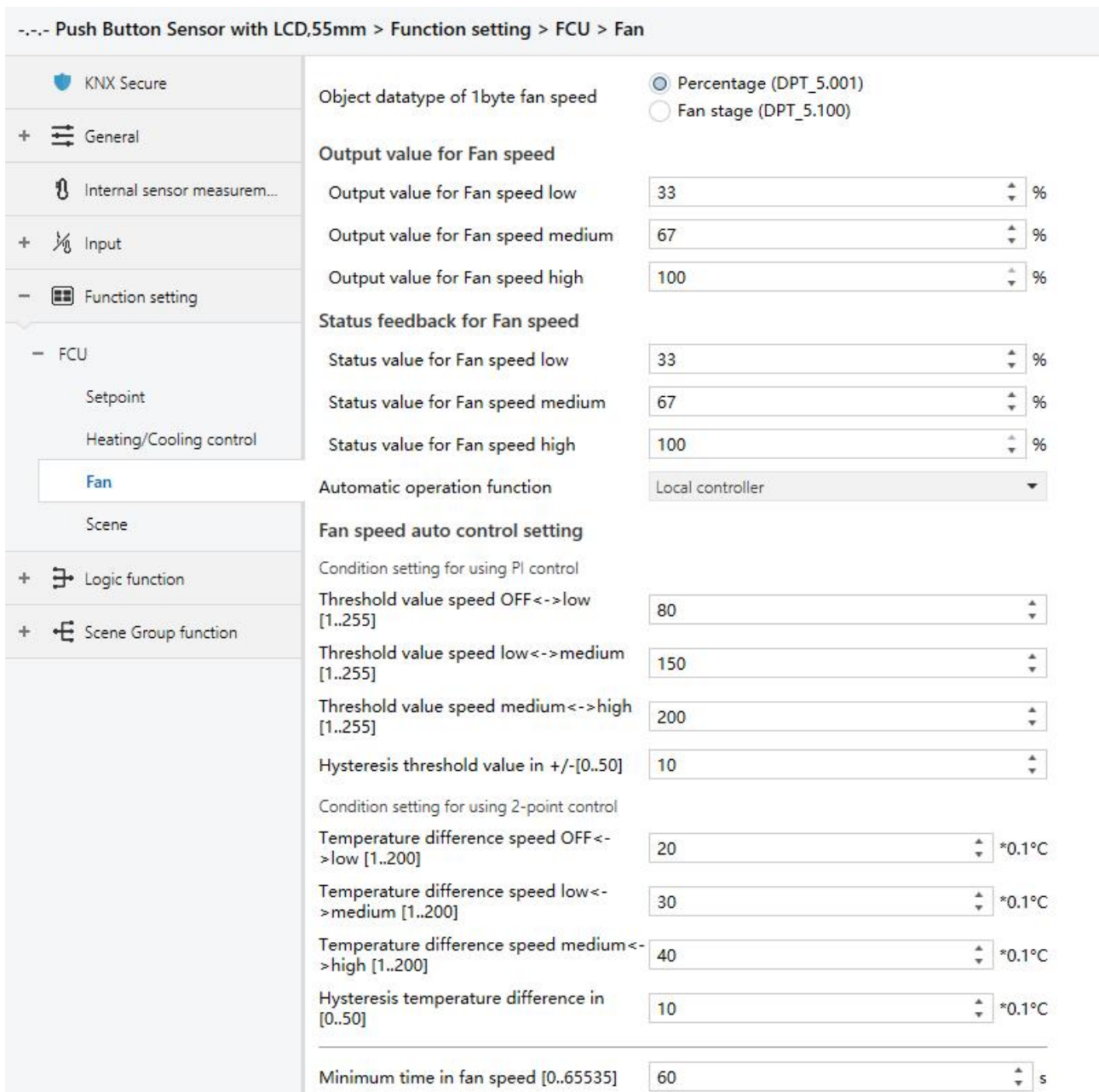

Fig.5.3.2.3 “Fan” parameter window

This parameter window is visible when fan speed control is enabled. After the download is complete, if the status is not read, the fan speed is off.

Parameter “Object datatype of 1byte fan speed”

This parameter is for setting the object datatype of 1 byte fan speed. Options:

**Percentage (DPT\_5.001)**

**Fan stage (DPT\_5.100)**

### Output value for fan speed

—Parameter “Output value for fan speed low/medium/high”

These three parameters are for setting the value sent for each fan speed switchover. Fan speed off when telegram value is 0. Options according to fan object datatype: **1..255 /1..100**

### Status feedback for fan speed

—Parameter “Status value for fan speed low/medium/high”

These three parameters are for setting the status feedback value of each fan speed. The device will update and display the fan speed according to the feedback value. Options according to fan object datatype: **1..255 /1..100**

**Note: the output value and status value must meet the condition low<medium<high, if not, they can not be modified on ETS, and display red box warning, as shown as follow:**

Output value for Fan speed low	<input type="text" value="33"/>	%
Output value for Fan speed medium	<input style="border: 2px solid red;" type="text" value="32"/>	%
Output value for Fan speed high	<input type="text" value="100"/>	%

### Parameter “Automatic operation function”

This parameter is for setting the control way of automatic operation. Options:

- Disable**
- Local controller**
- External controller**

When the work mode is “Slave”, there is no option “Local controller”, only can select “Disable” or “External controller”.

Parameters as follow are visible when “Local controller” is selected:

### Fan speed auto control setting

#### Condition setting for using PI control

Under PI control, control value is PI operated within program, controller will power on/off fan or switch fan speed according to the threshold range of the control values.

### Parameter “Threshold value speed OFF<-->low [1..255]”

Define threshold value for speed OFF<-->low, options: **1..255**

If the control value is greater than or equal to this setting threshold value, start to run low fan speed; if the control value is less than this setting threshold value, the fan will be turned off.

Parameter "Threshold value speed low<-->medium [1..255]"

Define threshold value for speed OFF<-->low, options: **1..255**

If the control value is greater than or equal to this setting threshold value, start to run low fan speed; if the control value is less than this setting threshold value, the fan will be turned off.

Parameter "Threshold value speed medium<-->high [1..255]"

Define the threshold for speed medium<-->high, if the control value is greater than or equal to this setting threshold, start to run high fan speed. Options: **1..255**

**Tip: The controller evaluates the threshold in ascending order.**

**First check →OFF <=>low fan speed threshold →low fan speed <=>medium fan speed →medium fan speed <=>high fan speed.**

**The correctness of functional execution is guaranteed only in this case:**

**The threshold of OFF <=> low fan speed is lower than that of low fan speed <=> medium fan speed, and the threshold of low fan speed <=> medium fan speed is lower than that of medium fan speed <=> high fan speed.**

Parameter "Hysteresis threshold value in +/-[0..50]"

This parameter is for setting the hysteresis value of the threshold value, which can avoid the unnecessary action of the fan when the control value fluctuates near the threshold. Options: **0..50**

If value is 0, no hysteresis. Fan switch to speed once control value greater than threshold value;

Suppose that hysteresis value is 10 and the threshold is 50, then the upper limit threshold 60 (Threshold value+Hysteresis value) and the lower limit threshold 40 (Threshold value-Hysteresis value). When the control value is between 40 ~60, fan action will not be caused, and the previous status will still be maintained. Only less than 40 or greater than or equal to 60 will change the running status of the fan.

## Condition setting for using 2-point control

Under 2-point control, controller will decide the fan power on/off or fan speed according to the temperature difference between the actual temperature and setpoint temperature.

Cooling: Temperature difference = actual temperature - setpoint temperature;

Heating: Temperature difference = setpoint temperature - actual temperature.

Parameter "Temperature difference speed OFF<-->low [1..200] \*0.1K"

This parameter is for setting the temperature difference for speed OFF<-->low.

Options: **1..200**

If the temperature difference is greater than or equal to this setting temperature difference, start to run low fan speed; if less than this setting temperature difference, the fan will be turned off.

Parameter "Temperature difference speed low<-->medium [1..200] \*0.1K"

Define the temperature difference for speed low<-->medium, if the control value is greater than or equal to this setting temperature difference, start to run medium fan speed.

Options: **1..200**

Parameter "Temperature difference speed medium<-->high [1..200] \*0.1K"

Define the temperature difference for speed medium<-->high, if the control value is greater than or equal to this setting temperature difference, start to run high fan speed. Options: **1..200**

Parameter "Hysteresis temperature difference in [0..50] \*0.1K"

This parameter is for setting the hysteresis value of the temperature difference, which can avoid the unnecessary action of the fan when the control value fluctuates near the temperature difference. Options: **0..50**

If value is 0, no hysteresis. Fan switch to speed once control value greater than temperature difference;

Suppose that hysteresis value is 0.5°C and the temperature difference is 1°C, then the upper limit temperature difference 1.5°C (Temperature difference+Hysteresis value) and the lower limit temperature difference 0.5°C (Temperature difference-Hysteresis value). When the control value is between 0.5°C~1.5°C, fan action will not be caused, and the previous status will still be maintained. Only less than 0.5°C or greater than or equal to 1.5°C will change the running status of the fan.

Parameter "Minimum time in fan speed [0..65535]s"

This parameter is both applied to PI control and 2-point control.

Defines the residence time of the fan from the current fan speed to a higher fan speed or lower fan speed, that is, the minimum time for a fan speed operation.

If you need to switch to another fan speed, you need to wait for this period of time before switching.

If the current fan speed has been running long enough, the fan speed can be changed quickly.

Options: **0..65535**

0: there is no minimum running time, but the delay switching time of fan speed still needs to be considered.

#### 5.5.2.1.4. Parameter window “Scene”

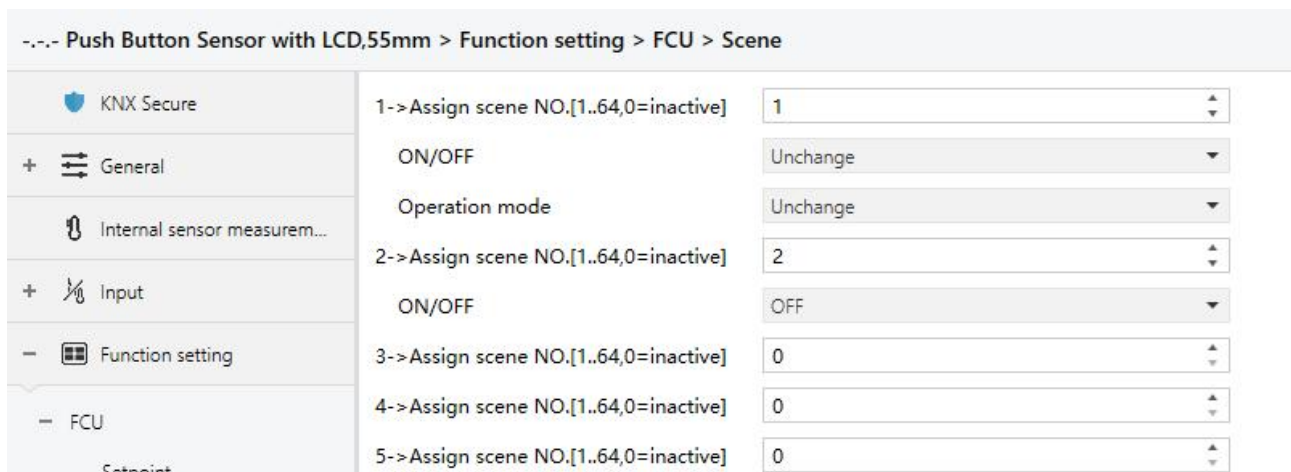

Fig.5.5.2.1.4 “Scene” parameter window

When the work mode is “Slave”, this parameter window is not visible.

This parameter window is visible when scene function is enabled.

#### Parameter “x->Assign scene NO.[1..64,0=inactive]”(x=1-5)

This parameter is for setting the triggered scene number. Up to support 5 triggered scenes.

Options: **0..64, 0=inactive**

Scenes can be recalled or stored. When a new scene is stored, the original saved new scene is still valid when the voltage is recovered again after the bus has been powered down.

These three parameters as follow are visible when the option is greater than 0:

#### Parameter “ON/OFF”

This parameter is for setting status of ON/OFF. Options:

**OFF**

**ON**

**Unchange**

These two parameters as follow are not visible when OFF is selected:

—Parameter "Temperature"

This parameter is visible when operation mode is disabled. Set the status of setpoint temperature. Options:

**5°C**

**6°C**

**..**

**37°C**

**Unchange**

When setpoint temperature of scene is less than the min. setpoint temperature, display following warning:

✘ The setpoint is less than minimum,so minimum will regard as setpoint in fact

When setpoint temperature of scene is greater than the max. setpoint temperature, display following warning:

✘ The setpoint is greater than maximum,so maximum will regard as setpoint in fact

—Parameter "Operation mode"

This parameter is visible when operation mode is enabled. Set the status of operation mode. Option:

**Comfort mode**

**Standby mode**

**Economy mode**

**Frost/heat protection**

**Unchange**



5.5.2.2. Parameter window “VRF setting”

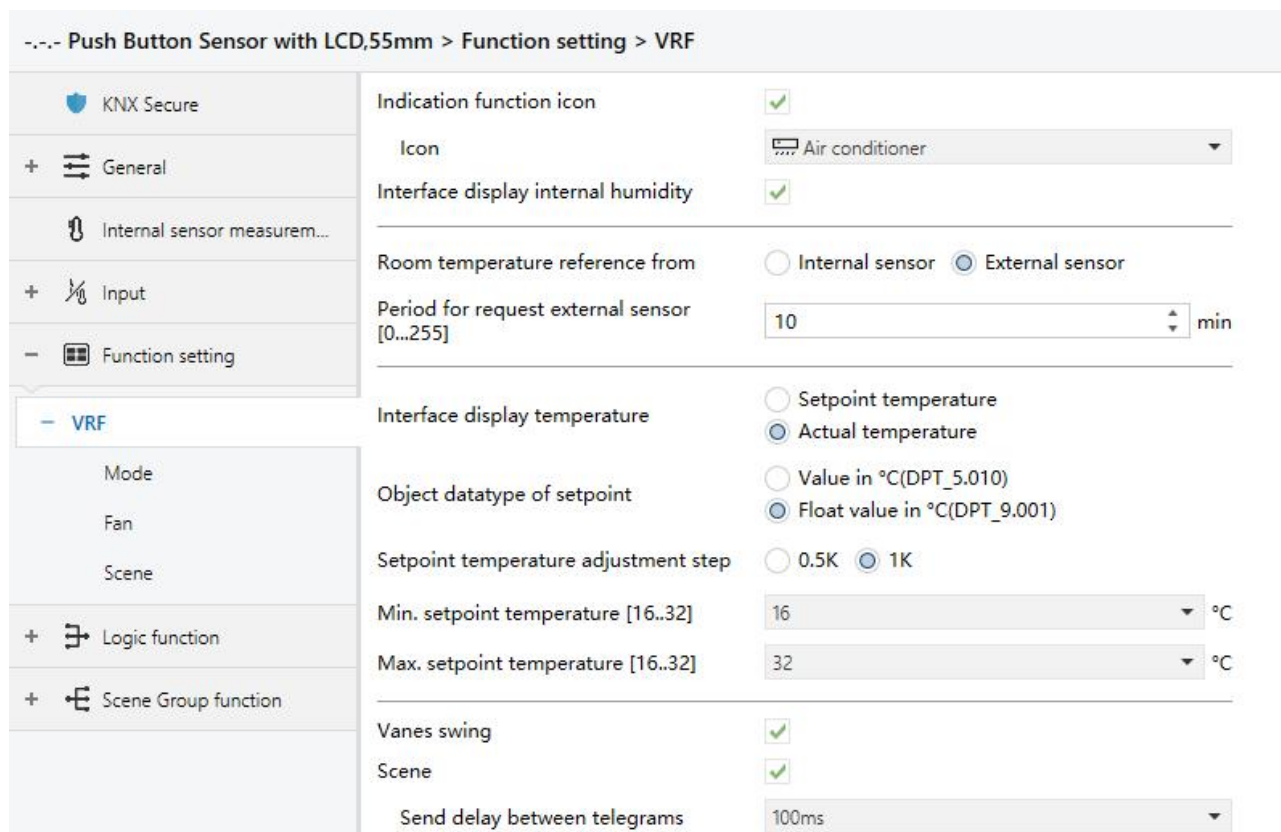

Fig.5.5.2.2 “VRF setting” parameter window

Parameter “Indication function icon”

This parameter is for setting whether to display the icon of VRF control on the screen.

When enabled, parameter as follow is visible:

—Parameter “Icon”

This parameter is for setting the function icon. Options:

**Air conditioner**

**Floor heating**

...

**Temperature**

The default icons corresponding to the function and the icons corresponding to the options are described in the appendix, please refer to chapter 8.2.

Parameter “Interface display internal humidity”

This parameter is for setting whether to display the internal humidity on the screen, the humidity is

determined by the setting of the “Internal sensor measurement” in the parameter interface, more details refer to chapter 5.3.

## Parameter “Room temperature reference from”

This parameter is for setting the resource of the room temperature reference. Options:

**Internal sensor**

**External sensor**

When selecting the reference internal sensor, the temperature is determined by the setting of the “Internal sensor measurement” in the parameter interface, more details refer to chapter 5.3.

### —Parameter “Period for request external sensor [0...255]min”

This parameter is visible when “External sensor” is selected. Set the time period for read request external temperature sensor. Options: **0..255**

## Parameter “Interface display temperature”

This parameter is for setting the interface display temperature under the normal status. Options:

**Setpoint temperature**

**Actual temperature**

If display actual temperature, it just to wake up when firstly adjust setpoint temperature, and not send telegram.

## Parameter “Object datatype of setpoint”

This parameter is for setting the object datatype of setpoint temperature. Options:

**Value in °C (DPT\_5.010)**

**Int, data of actual temperature**

**Float value in °C (DPT\_9.001)**

**Float, data of standard KNX temperature**

## Parameter “Setpoint temperature adjustment step”

This parameter is for setting step value of setpoint temperature. Options display according to datatype:

**0.5K**

**1K**

When “Value in °C (DPT\_5.010)” is selected, only **1K**

Parameter “Min./Max. setpoint temperature [16..32]° C”

These parameters are for setting the adjustable range of the setpoint temperature, the minimum value should be less than the maximum value. Options:

- 16°C**
- 17°C**
- ...**
- 32°C**

If the setpoint temperature beyond the limited range, the will output the limited temperature.

**For setpoint temperature, the Min. value must less than the Max., if not, it can not be modified on ETS.**

Parameter “Vanes swing”

This parameter is for setting whether to enable vanes swing function, when enabled, swing =1 or stop =0 via 1 bit object.

Long press button to swing/stop the function, specific operation please refer to chapter 7.2.4.

Parameter “Scene”

This parameter is for setting whether to enable scene function is visible. When enabled, link to power on/off, mode, fan speed, setpoint temperature.

—Parameter “Send delay between telegrams”

This parameter is visible when scene function enabled. Set the delay time between the sending telegrams.

Options:

- Disable**
- 100ms**
- 300ms**
- 500ms**

5.5.2.2.1. Parameter window “Mode”

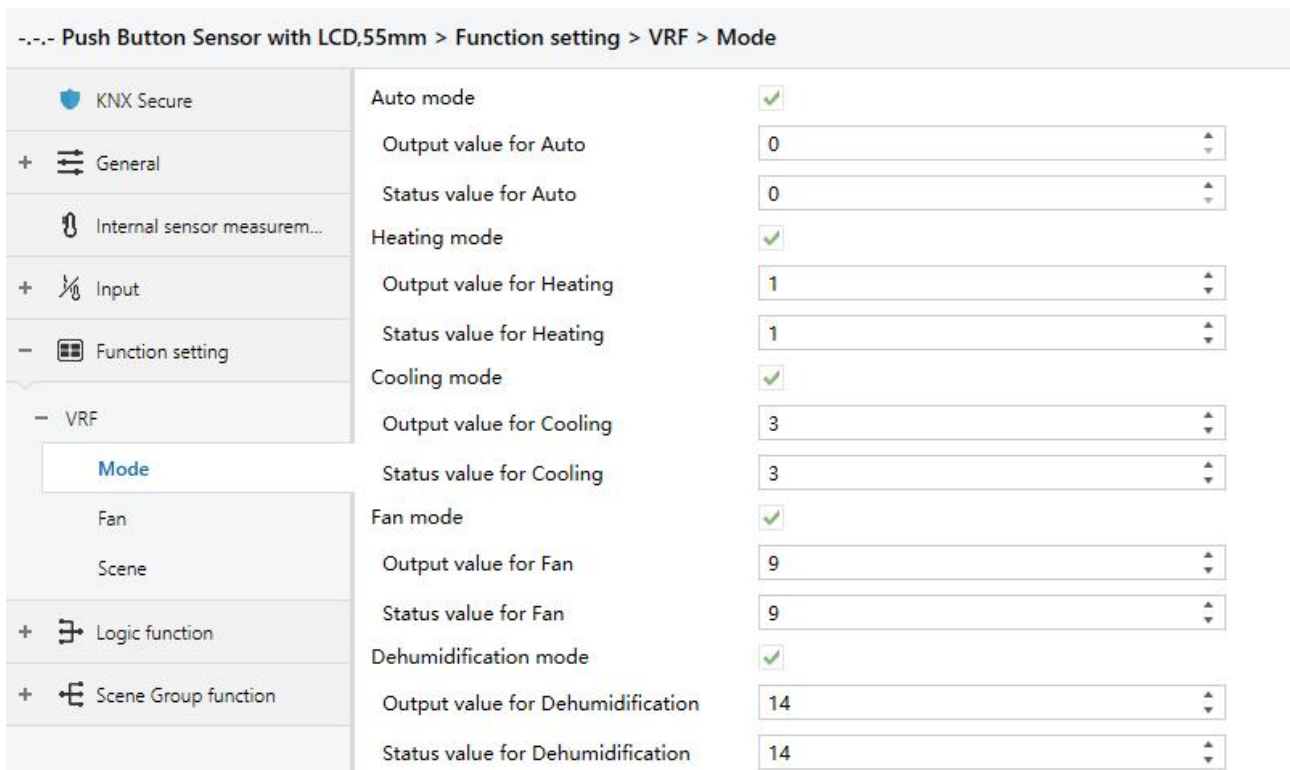

Fig.5.5.2.2.1 “Mode” parameter window

Parameter “Auto/Heating/Cooling/Fan/Dehumidification mode”

Corresponding setting parameters are visible when these parameters are enabled.

---Parameter “Output value for auto/heating/cooling/fan/dehumidification[0..255]”

These parameters are visible when modes enabled. Set the output value of each mode. Options: **0..255**

---Parameter “Status value for auto/heating/cooling/fan/dehumidification [0..255]”

These parameters are visible when modes enabled. Set the status feedback value of each mode.

Options: **0..255**

5.5.2.2.2.Parameter window “Fan”

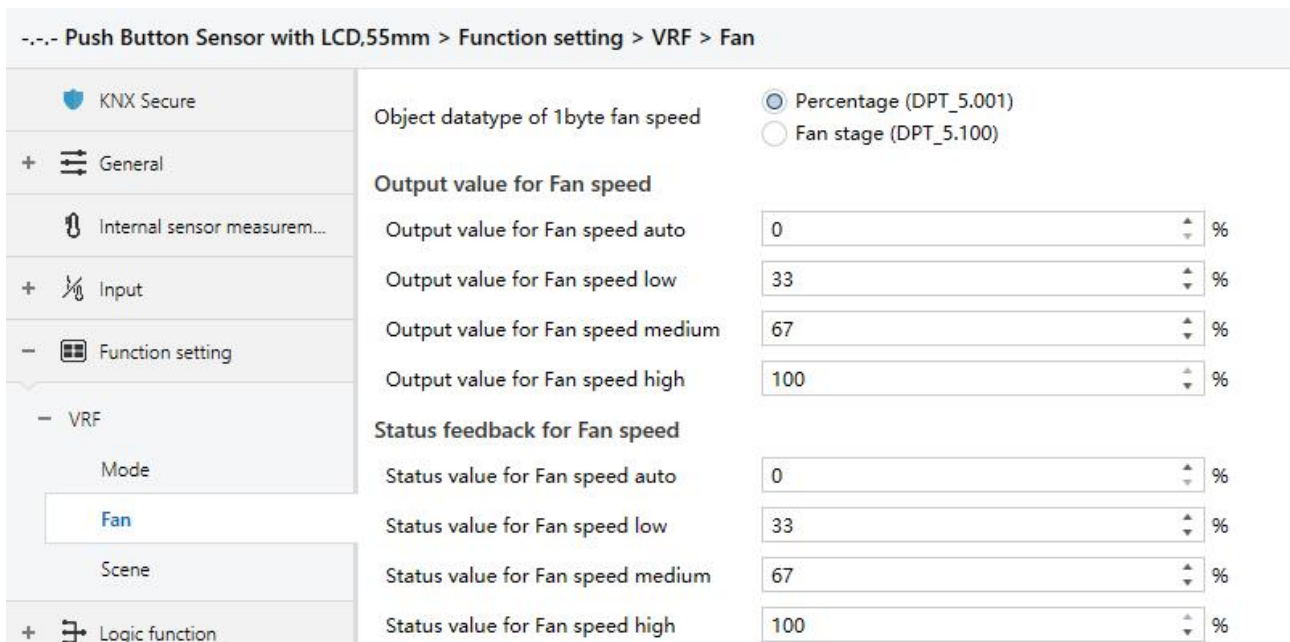

Fig.5.5.2.2.2 “Fan” parameter window

Parameter “Object datatype of 1byte fan speed”

This parameter is for setting the object datatype of 1 byte fan speed. Options:

**Fan stage (DPT 5.100)**

**Percentage (DPT 5.001)**

**Output value for fan speed**

Parameter “Output value for fan speed auto/low/medium/high”

These parameters are for setting the value sent for each fan speed switchover, support 4 fan speeds auto, low, medium, high. Options according to fan object datatype: **0..255/0..100**

**Status feedback for fan speed**

Parameter “Status value for fan speed auto/low/medium/high”

These parameters are for setting the status feedback value for each fan speed, support 4 fan speeds auto, low, medium, high. Device updates display according to feedback values.

Options according to fan object datatype: **0..255/0..100**

**Note: the output value and status value must meet the condition low<medium<high, and auto fan speed is not limited. If not, they can not be modified on ETS, and display red box warning, as shown as follow:**

Output value for Fan speed auto	0	%
Output value for Fan speed low	68	%
Output value for Fan speed medium	67	%
Output value for Fan speed high	100	%

### 5.5.2.2.3. Parameter window “Scene”

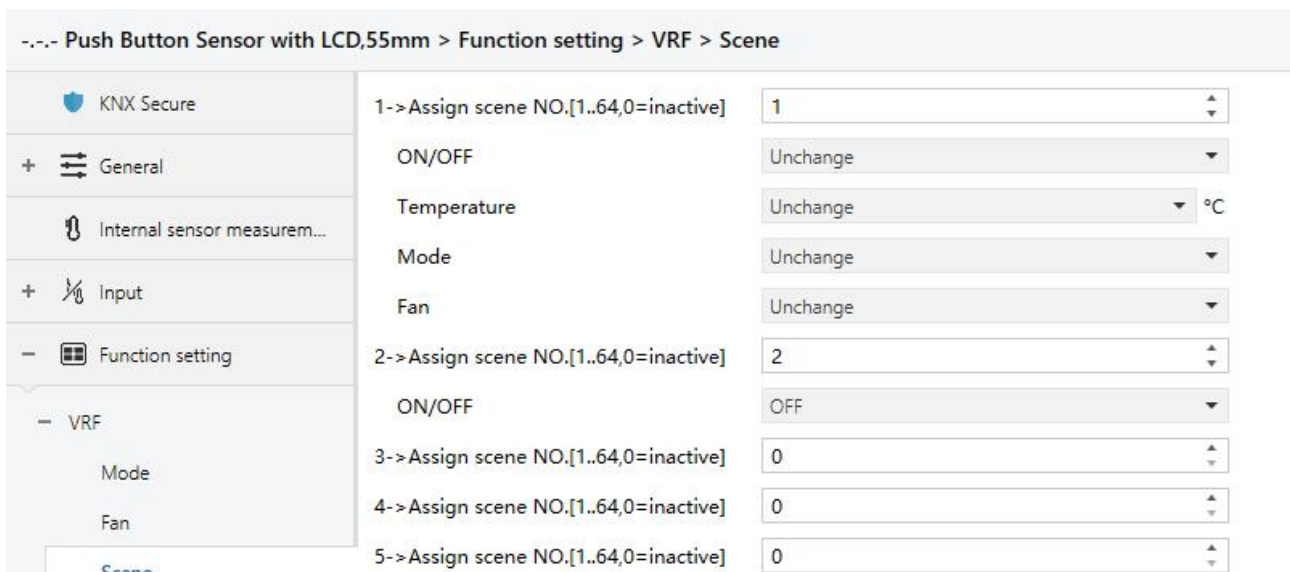

Fig.5.5.2.2.3 “Scene” parameter window

This parameter window is visible when scene function is enabled.

#### Parameter “x->Assign scene NO.[1..64,0=inactive]”(x=1-5)

This parameter is for setting the triggered scene number. Up to support 5 triggered scenes.

Options: **0..64, 0=inactive**

These four parameters as follow are visible when the option is greater than 0:

#### Parameter “ON/OFF”

This parameter is for setting status of ON/OFF. Options:

**OFF**

**ON**

**Unchange**

These three parameters as follow are not visible when OFF is selected:

—Parameter “Temperature”

This parameter is for setting the status of setpoint temperature. Options:

**16°C**

**17°C**

**..**

**32°C**

**Unchange**

When setpoint temperature of scene is less than the min. setpoint temperature, display following warning:

✘ The setpoint is less than minimum,so minimum will regard as setpoint in fact

When setpoint temperature of scene is greater than the max. setpoint temperature, display following warning:

✘ The setpoint is greater than maximum,so maximum will regard as setpoint in fact

—Parameter “Mode”

This parameter is for setting the status of mode. Options:

**Auto**

**Heating**

**Cooling**

**Fan**

**Dehumidification**

**Unchange**

—Parameter “Fan”

This parameter is for setting the status of fan speed. Options:

**Auto**

**Low**

**Medium**

**High**

**Unchange**

**Note: ON/OFF, temperature, mode and fan speed send in order. If not finish during delay time and have a new command, perform the new one. Unperformed operations are ignored.**



5.5.2.3. Parameter window “Floor heating setting”

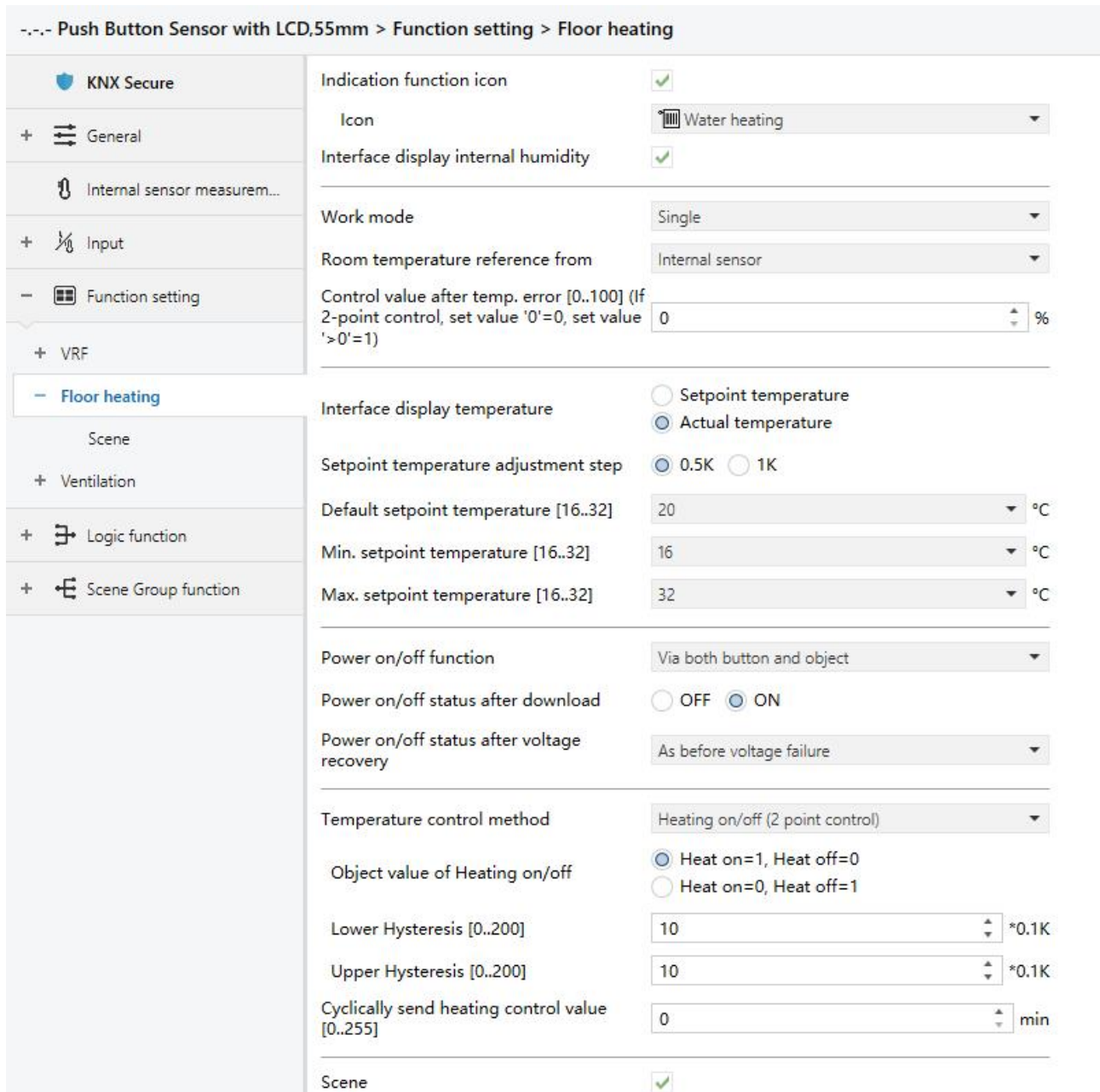

Fig.5.5.2.3 “Floor heating setting” parameter window

Parameter “Indication function icon”

This parameter is for setting whether to display the icon of floor heating on the screen.

When enabled, parameter as follow is visible:

—Parameter “Icon”

This parameter is for setting the function icon. Options:

**Air conditioner**

**Floor heating**



...

### **Temperature**

The default icons corresponding to the function and the icons corresponding to the options are described in the appendix, please refer to chapter 8.2.

#### Parameter “Interface display internal humidity”

This parameter is for setting whether to display the internal humidity on the screen, the humidity is determined by the setting of the “Internal sensor measurement” in the parameter interface, more details refer to chapter 5.3.

#### Parameter “Work mode”

This parameter is for setting the work mode of floor heating. Options:

**Single**

**Master**

**Slave**

Single: floor heating function of the device is set to single control and with a temperature control algorithm, the output directly controls the actuator, when the device restarts, it sends the current status to the bus, such as power on/off, setpoint temperature;

Master: floor heating function of the device is set to multi-control and with a temperature control algorithm, the output is dominated by the device. When the device restarts, it sends the current status to the bus, such as power on/off, setpoint temperature;

Slave: floor heating function of the device is set to slave control, at this time it is only used as touch and display, no temperature control algorithm, when the device restarts, it will send the status read request, such as power on/off, setpoint temperature.

#### Parameter “Room temperature reference from”

This parameter is for setting the resource of the room temperature reference. Options:

**Internal sensor**

**External sensor**

**Internal sensor combine with External sensor**

When selecting the reference internal sensor, the temperature is determined by the setting of the “Internal

sensor measurement” in the parameter interface, more details refer to chapter 5.3.

—Parameter “Period for request external sensor [0...255]min”

This parameter is visible when “...External sensor” is selected. Set the time period for read request external temperature sensor. Options: **0..255**

Parameters as follow are visible when “Internal sensor combine with External sensor” is selected.

—Parameter “Combination ratio”

This parameter is for setting the internal sensor and the external sensor to measure the specific gravity of the temperature. Options:

**10% Internal to 90% External**

**20% Internal to 80% External**

...

**90% Internal to 10% External**

For example, if the option is “40% internal to 60% external”, then the internal sensor accounts for 40%, the external sensor accounts for 60%, and the control temperature = (internal sensor's temperature × 40%) + (external sensor's temperature × 60%), the RTC function of the device will control and display the temperature according to the calculated temperature.

When two sensors are combined for detection, when one sensor is in error, the temperature value detected by the other sensor is used.

—Parameter “Send temperature when the result change by [0...10]K”

This parameter is for setting when temperature turns to a certain value, whether to enable to send the current temperature value to the bus. Not send when disable. Options:

**Disable**

**0.5K**

**1.0K**

...

**10.0K**

—Parameter “Cyclically send temperature [0...255,0=inactive]min”

Setting the time for cyclically sending the temperature detection value to the bus. Not send when value is 0.

Options: **0..255**

**Note: cyclically sending and change sending are independent of each other.**

Parameter "Control value after temp. error[0..100]%" (if 2-point control, set value '0'=0, set value '>0'=1)"

When the work mode is "Slave", this parameter is not visible.

Set the control value when temperature error occur. Options: **0..100**

If 2-Point control, then the parameter value is 0, as well as the control value; if the parameter value is more than 0, then the control value will be 1.

Parameter "Interface display temperature"

This parameter is for setting the interface display temperature under the normal status. Options:

**Setpoint temperature**

**Actual temperature**

If display actual temperature, it just to wake up when firstly adjust setpoint temperature, and not send telegram.

Parameter "Setpoint temperature adjustment step"

This parameter is for setting step value of setpoint temperature. Options:

**0.5K**

**1K**

Parameter "Default setpoint temperature [16..32]° C"

When the work mode is "Slave", this parameter is not visible.

Set the default set temperature when floor heating is on. Options:

**16°C**

**17°C**

...

**32°C**

When the default setpoint temperature is less than the min. setpoint temperature, display following warning:

 The setpoint is less than minimum,so minimum will regard as setpoint in fact

When the default setpoint temperature is greater than the max. setpoint temperature, display following warning:

 The setpoint is greater than maximum,so maximum will regard as setpoint in fact

Parameter "Min./Max. setpoint temperature [16..32]° C"

These two parameters are for setting the adjustable range of the setpoint temperature. The minimum value

should be less than the maximum value.

If the setpoint temperature beyond the limited range, it will output the limited temperature. Options:

**16°C**

**17°C**

...

**32°C**

**For setpoint temperature, the Min. value must less than the Max., if not, it can not be modified on ETS.**

#### Parameter "Power on/off function "

This parameter is for setting whether to enable power on/off function of controller. Options:

**Disable**

**Via button only**

**Via object only**

**Via both button and object**

Disable: power on/off function of controller is disabled;

Via button only: control power on/off only via the panel button;

Via object only: control power on/off only via the object;

Via both button and object: control power on/off both via the panel button and object.

These two parameter as follow and objects are visible when enabled:

#### Parameter "Power on/off status after download "

When the work mode is "Slave", this parameter is not visible.

Set the power on/off status of floor heating interface after download. Options:

**OFF**

**ON**

#### Parameter "Power on/off status after power on"

When the work mode is "Slave", this parameter is not visible.

Set the power on/off status of floor heating interface after device voltage recovery. Options:

**OFF**

**ON**

**As before voltage failure**

OFF: floor heating interface is off when device is powered on, the interface are not operational and can not to calculate internally and control;

ON: floor heating interface is on when device is powered on, this interface is operational, floor heating will calculate internally according to the control type to determine the current controlling status;

As before voltage failure: floor heating interface will recover to the status before voltage failure, if it is on, then the device will send the heating control status according to the internal calculation.

**Parameter “Temperature control method”**

When the work mode is “Slave”, this parameter is not visible.

Set the temperature control method, different control types are suitable for different temperature controller.

Options:

**Heating on/off (2 point control)**

**Heating PWM (use PI control)**

**Heating continuous control (use PI control)**

**These parameters as follow are visible when “Heating on/off (use 2-point control)” is selected:**

Under 2-point control, when the temperature is higher than a certain setpoint temperature, heating off, below a certain setpoint temperature, heating on.

——Parameter “Object value of Heating on/off”

Define the triggered value of floor heating on/off. Options:

**Heat on=1, Heat off=0**

**Heat on=0, Heat off=1**

——Parameter “Lower Hysteresis [0..200]\*0.1K”

——Parameter “Upper Hysteresis [0..200]\*0.1K”

These two parameters for setting the lower/upper hysteresis setpoint temperature of floor heating.

Options: **0..200**

**When the actual temperature(T) > the setpoint temperature + the upper hysteresis temperature, then will stop heating;**

**When the actual temperature(T) < the setpoint temperature - the lower hysteresis temperature, then**

will start heating.

For example, the lower hysteresis temperature is 1K, the upper hysteresis temperature is 2K, the setpoint temperature is 16°C, if T is higher than 18°C, then it will stop heating; if T is lower than 15°C, then it will start heating; if T is between 15~18°C, then it will maintain the previous status.

**These parameters as follow are visible when “Heating PWM (use PI control)” or “Heating continuous control (use PI control)” is selected:**

When in Heating PWM (use PI control), floor heating will in cyclically switch control to the valve according to the controlling value.

When in Heating continuous control (use PI control), floor heating will control the opening/closing status of the valve according to the controlling value.

——**Parameter “Invert control value”**

This parameter is for setting whether to invert control value or normal sending control value, so that the control value will be suitable for the valve type.

When enabled, send the control value to the bus through objects after inverting the control value.

——**Parameter “PWM cycle time [1..255] min”**

This parameter is visible only when the control type is “Heating PWM (use PI control)” and is used to set the cycle of the control object cycle to send the switch value, and the object sends the switch value according to the duty cycle of the control value. For example, assuming the set period is 10 min and the control value is 80%, the object sends an open telegram to the 8min and the 2min sends a closed telegram. If the control value changes, The duty cycle of the object to send the on/off telegram also changes, but the period is still the time of the parameter setting. Options: **1...255**

——**Parameter “Heating speed”**

This parameter is Setting for the response speed of the heating PI controller. Different response speeds apply to different environments. Options:

**Hot water heating (5K/150min)**

**Underfloor heating (5K/240 min)**

**Electrical heating (4K/100min)**

**User defined**

—Parameter “Proportional range [10..100]\*0.1K”(P value)

—Parameter “Reset time[0..255]min”(I value)

These two parameters are visible when “User defined” is selected. Set the PI value of PI controller.

Options: **10..100 (P value)**

Options: **0..255 (I value)**

—Parameter “Send control value on change by [0..100,0=inactive]”%

This parameter is visible when “Continuous control (use PI control)” is selected. Set the changing value of the control value to be sent to the bus. Options: **0..100, 0=inactive**

**More descriptions of two-point control mode and PI control mode refer to chapter 5.5.2.1.2.**

Parameter “Cyclically send control value [0..255]min”

This parameter is both applied to PI control and 2-point control. Set the period for cyclically sending the control value to the bus. Options: **0..255**

Parameter “Scene”

When the work mode is “Slave”, this parameter is not visible.

Set whether to enable scene function is visible. When enabled, link to power on/off, setpoint temperature.

**5.5.2.3.1.Parameter window “Scene”**

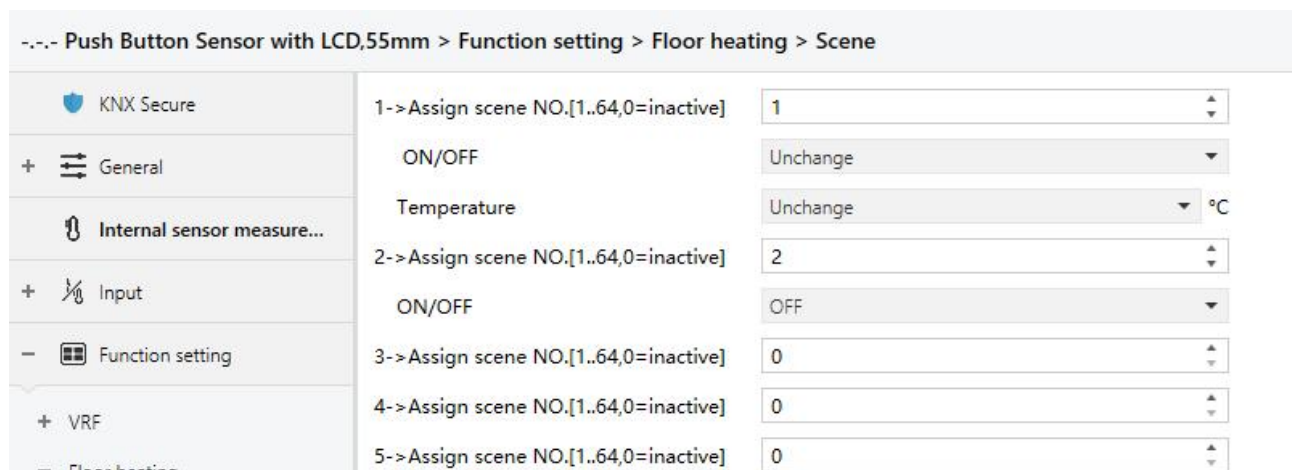

Fig.5.5.2.3.1 “Scene” parameter window

When the work mode is “Slave”, this parameter window is not visible.

This parameter window is visible when scene function is enabled.

## Parameter "x> Assign scene NO.[1..64,0=inactive]"(x=1-5)

This parameter is for setting the triggered scene number. Up to support 5 triggered scenes.

Options: **0..64, 0=inactive**

Scenes can be recalled or stored. When a new scene is stored, the original saved new scene is still valid when the voltage is recovered again after the bus has been powered down.

These two parameters as follow are visible when the option is greater than 0:

## Parameter "ON/OFF"

This parameter is for setting status of ON/OFF. Options:

**OFF**

**ON**

**Unchange**

This parameter as follow is not visible when OFF is selected:

## Parameter "Temperature"

This parameter is for setting the status of setpoint temperature. Options:

**16°C**

**17°C**

...

**32°C**

**Unchange**

When setpoint temperature of scene is less than the min. setpoint temperature, display following warning:

✘ The setpoint is less than minimum,so minimum will regard as setpoint in fact

When setpoint temperature of scene is greater than the max. setpoint temperature, display following warning:

✘ The setpoint is greater than maximum,so maximum will regard as setpoint in fact



5.5.2.4. Parameter window “Ventilation setting”

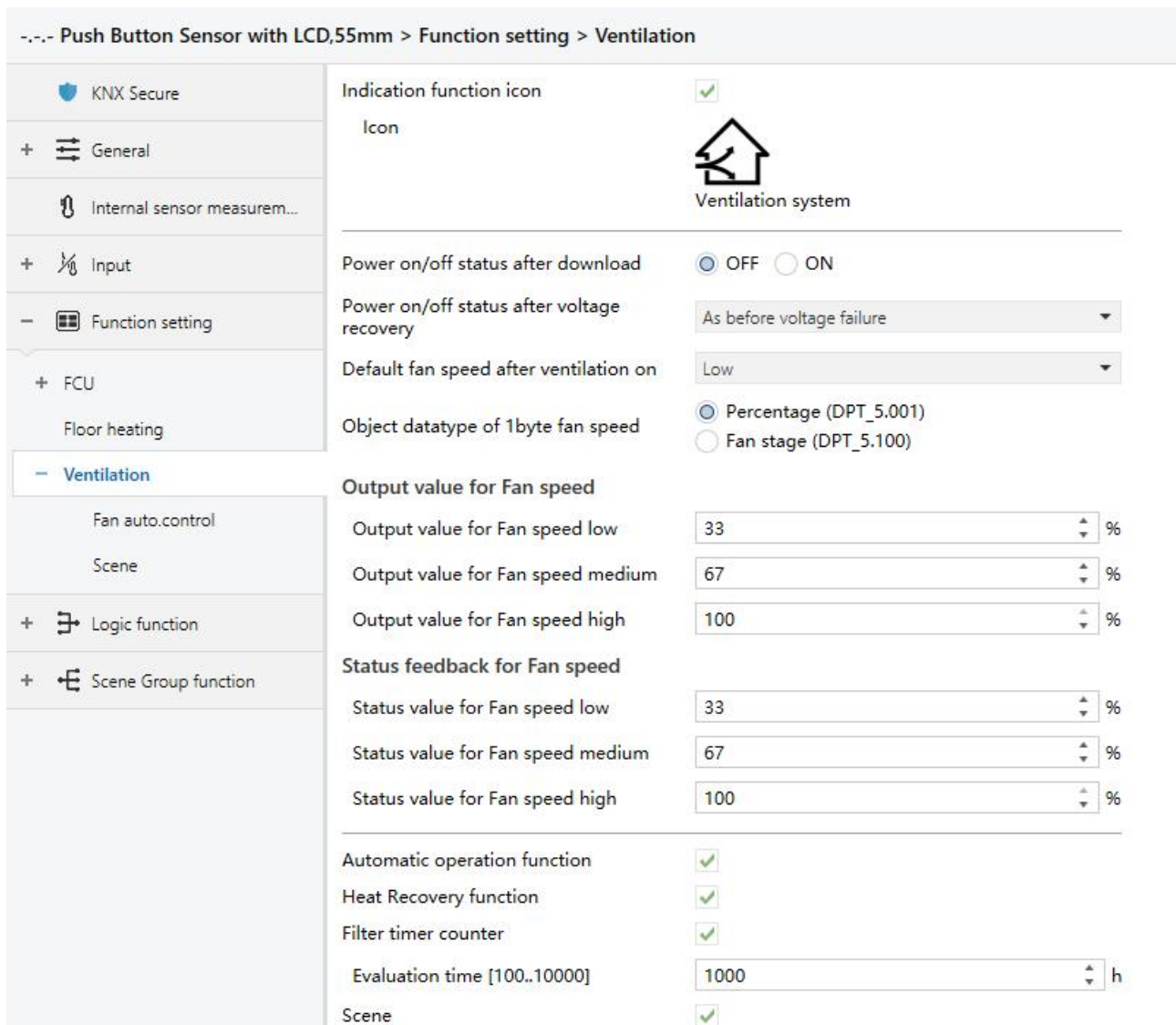

Fig.5.5.2.4 “Ventilation setting” parameter window

Parameter “Indication function icon”

This parameter is for setting whether to display the icon of ventilation function on the screen.

When enabled, parameter as follow is visible:

—Parameter “Icon”

This parameter is for setting the function icon. Option is only **Ventilation system**

The default icons corresponding to the function and the icons corresponding to the options are described in the appendix, please refer to chapter 8.2.

Parameter “Power on/off status after download ”

This parameter is for setting the power on/off status of the ventilation system interface after the application is

downloaded. Options:

**OFF**

**ON**

Parameter "Power on/off status after voltage recovery"

This parameter is for setting the power on/off status of ventilation system interface after device voltage recovery. Options:

**OFF**

**ON**

**As before voltage failure**

OFF: device will power off when voltage recovery, this interface can not be operated, except for filter reset and power ON/OFF;

ON: device will power on when voltage recovery, this interface can be operated;

As before voltage failure: device will return to the power status as before voltage failure when voltage recovery.

Parameter "Default fan speed after ventilation on"

This parameter is for setting the initial fan speed after ventilation on. Options:

**Low**

**Medium**

**High**

**Last status**

When "Last status" is selected, if not sure the fan speed, enable the low fan speed as default.

Parameter "Object datatype of 1byte fan speed"

This parameter is for setting the object datatype of 1 byte fan speed. Options:

**Fan stage (DPT 5.100)**

**Percentage (DPT 5.001)**

## Output value for fan speed

—Parameter "Output value for fan speed low/medium/high"

These three parameters are for setting the value sent for each fan speed switchover. Fan speed off when

telegram value is 0. Options according to fan object datatype: **1..255 /1..100**

### Status feedback for fan speed

—Parameter “Status value for fan speed low/medium/high”

These three parameters are for setting the status feedback value of each fan speed. The device will update and display the fan speed according to the feedback value. Options according to fan object datatype: **1..255 /1..100**

**Note: the output value and status value must meet the condition low<medium<high, if not, they can not be modified on ETS, and display red box warning, as shown as follow:**

Output value for Fan speed low	<input style="border: 2px solid red;" type="text" value="68"/>	%
Output value for Fan speed medium	<input type="text" value="67"/>	%
Output value for Fan speed high	<input type="text" value="100"/>	%

### Parameter “Automatic operation function”

This parameter is for setting whether to enable fan speed auto function. When enabled, it can be linked with PM2.5 or CO2 and VOC measurement value, the sensor data is achieved from the bus.

Telegram 1 is to active the auto fan speed, 0 is cancel.

### Parameter “Filter timer counter”

This parameter is for setting whether to enable the function of filter timer counter.

—Parameter “Evaluation time [100..10000]h”

This parameter is visible when previous parameter is enabled.

Set the service life of the filter. Options: **100..10000**

If the filter takes longer than the setting time, the filter will send an alarm and prompt to clean the filter.

The life length of the filter can be reset through the object “Filter timer reset”, long press Fan button **3s** also can reset the life length. And send the reset telegram to the bus.

The life length of the filter can be counted by the object “Filter timer counter”. The counting duration is in hours. The counting value will be sent to the bus when it has changed, and the counting duration of filter can be modified by the object “Filter timer counter change”.

### Parameter “Scene”

This parameter is for setting whether to enable scene function is visible. When enabled, link to fan speed and heat recovery.

**5.5.2.4.1.Parameter window “Fan auto.control”**

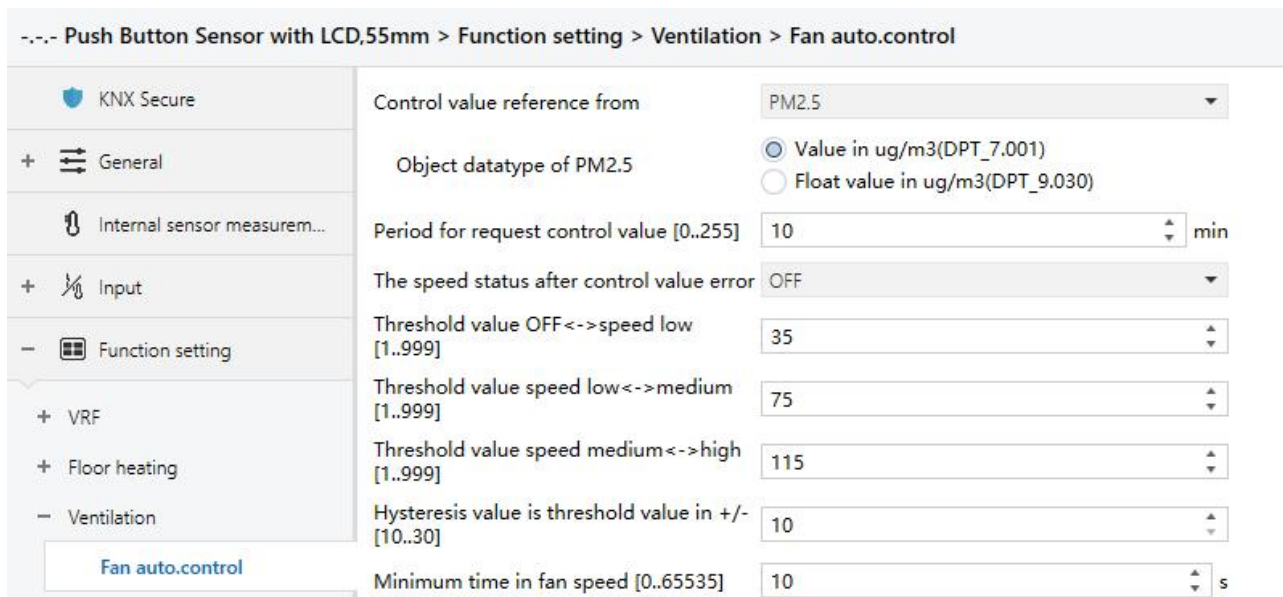

Fig.5.5.2.4.1 “Fan auto.control” parameter window

This parameter window is visible when automatic operation function is enabled.

**Parameter “Control value reference from”**

This parameter is for setting the reference of control value under automatic operation. Options:

**CO2**

**PM2.5**

**VOC**

**Parameter “Object datatype of CO2”**

This parameter is for setting the datatype of CO2. Datatype determines object type, select it according to the docking CO2 sensor data type. Options:

**Value in ppm(DPT\_7.001)**

**Float value in ppm(DPT\_9.008)**

DPT\_7.001: Suitable for integrated value.

DPT\_9.008: Suitable for float value.

**Parameter “Object datatype of PM2.5/VOC”**

These two parameters are for setting the datatype of PM2.5/VOC. Datatype determines object type, select it according to the docking PM2.5 or VOC sensor data type. Options:

**Value in ug/m3(DPT\_7.001)**

**Float value in ug/m3(DPT\_9.030)**

DPT\_7.001: Suitable for integrated value.

DPT\_9.030: Suitable for float value.

Parameter "Period for request control value [0...255]min"

This parameter is for setting the time period for device to send a control value read request to external sensor after bus recovery or finish programming (**After stabilization time 2min, then read**). Options: **0..255**

Parameter "Threshold value speed OFF<-->low [1..999]/ [1...4000]"

Define threshold value for speed OFF<-->low, options: **1..999/1..4000**

If the control value is greater than or equal to this setting threshold value, start to run low fan speed; if the control value is less than this setting threshold value, the fan will be turned off.

Parameter "Threshold value speed low<-->medium [1..999]/ [1...4000]"

Define the threshold value for speed low<-->medium, if the control value is greater than or equal to this setting threshold, start to run medium fan speed. Options: **1..999/1..4000**

Parameter "Threshold value speed medium<-->high [1..999]/ [1...4000]"

Define the threshold for speed medium<-->high, if the control value is greater than or equal to this setting threshold, start to run high fan speed. Options: **1..999/1..4000**

**Tip: The controller evaluates the threshold in ascending order.**

**First check → OFF <-->low fan speed threshold →low fan speed <-->medium fan speed →medium fan speed <-->high fan speed.**

**The correctness of functional execution is guaranteed only in this case:**

**The threshold of OFF <--> low fan speed is lower than that of low fan speed <--> medium fan speed, and the threshold of low fan speed <--> medium fan speed is lower than that of medium fan speed <--> high fan speed.**

Parameter "Hysteresis threshold value in +/- [10...30]/[100..400]"

This parameter is for setting the hysteresis value of the threshold value, which can avoid the unnecessary action of the fan when the control value fluctuates near the threshold. Options: **10..30/100..400**

For example, the control type is CO2, the Hysteresis value is 100 and the threshold is 450, then the upper limit threshold 550 (Threshold value+Hysteresis value) and the lower limit threshold 350 (Threshold

value-Hysteresis value). When the control value is between 350 ~550, fan action will not be caused, and the previous status will still be maintained. Only less than 350 or greater than or equal to 550 will change the running status of the fan. As shown in the following figure:

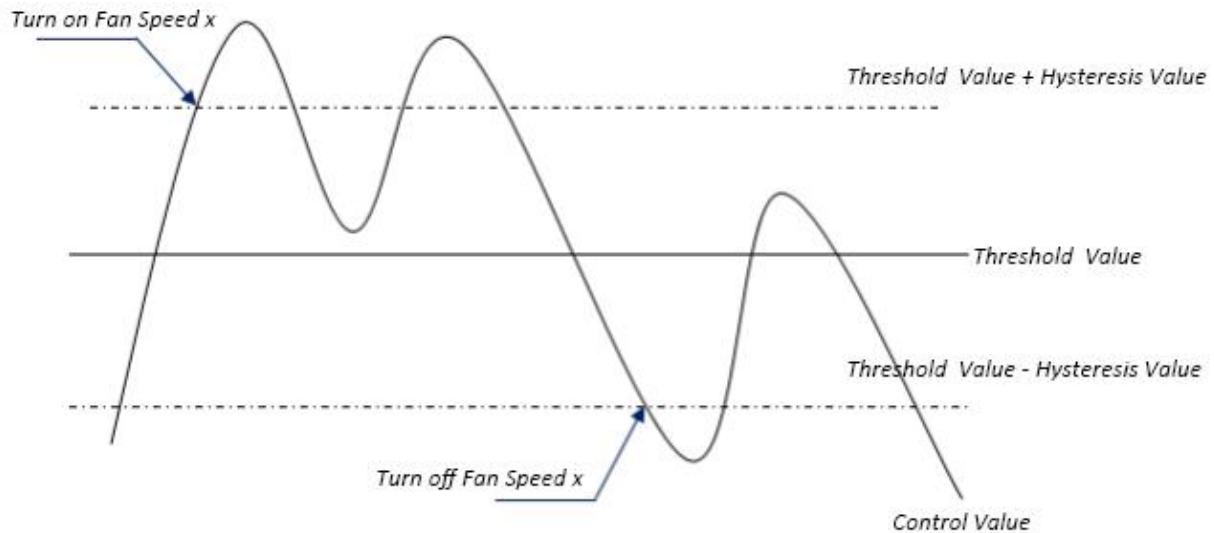

**Note:**

When hysteresis is enabled, if the threshold overlap occurs, fan action is specified as follows:

- 1) Hysteresis determines the control point where Fan speed conversion occurs;
- 2) If Fan speed conversion occurs, new fan speed is determined by control value and threshold value,

irrespective of hysteresis.

For example (1):

Take PM2.5 as an example

OFF <-> Low fan speed threshold value is 35

Low fan speed <-> Medium fan speed threshold value is 55

Medium fan speed <-> High fan speed threshold value is 75

Hysteresis value is 25

The fan speed of the fan turbine increases from OFF:

Fan OFF status will change at a control value of 60 ( $\geq 25+35$ ), and new fan speed will be the mid-fan speed (because 60 is between 55 and 75, irrespective of hysteresis at this time), so the low fan speed is ignored;

The behavior of fan speed when descending from a high fan speed:

The high fan speed will change at a control value of 50 ( $< 75-25$ ), and new fan speed will be low fan speed (because 50 is between 35 and 55, irrespective of hysteresis), so the fan speed is ignored.

**For example(2):**

**Take PM2.5 as an example**

**OFF <-> Low fan speed threshold value is 20**

**Low fan speed <->Medium fan speed threshold value is 40**

**Medium fan speed <-> High fan speed threshold value is 70**

**Hysteresis value is 10**

**When fan speed is increasing from OFF:**

**The OFF status will be turned when the control value is 30 ( $\geq 20+10$ )**

**When the control value 41 is received, the new speed will be at medium(because the hysteresis is ignored when the value 41 is between 40 and 70), therefore the low speed is ignored.**

**When the control value 39 is received, the new speed will be at low (because the hysteresis is ignored when the value 39 is between 20 and 40)**

**When Fan Speed decreasing from high:**

**The high speed will be turned when the control value is 60 ( $< 70-10$ )**

**When the control value 39 is received, the new speed will be at low(because the hysteresis is ignored when the value 39 is between 20 and 40),therefore the medium speed is ignored.**

**3) When the control value is 0,the fan will be off at any circumstances.**

Parameter "Minimum time in fan speed {0..65535}s"

Defines the residence time of the fan from the current fan speed to a higher fan speed or lower fan speed, that is, the minimum time for a fan speed operation. Options: **0..65535**

If you need to switch to another fan speed, you need to wait for this period of time before switching.

If the current fan speed has been running long enough, the fan speed can be changed quickly.

0: there is no minimum running time, but the delay switching time of fan speed still needs to be considered.

**Note: The residence time for this parameter setting is only enabled in Auto mode.**

5.5.2.4.2.Parameter window “Scene ”

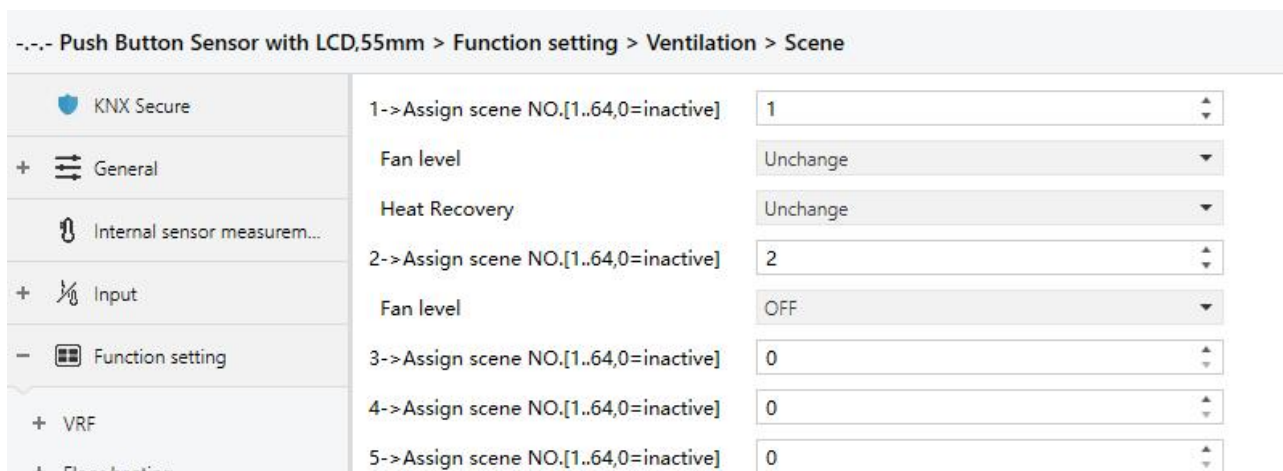

Fig.5.5.2.4.2 “Scene” parameter window

This parameter window is visible when scene function is enabled.

Parameter “x-> Assign scene NO.[1..64,0=inactive]”(x=1-5)

This parameter is for setting the triggered scene number. Up to support 5 triggered scenes.

Options: **0..64, 0=inactive**

These two parameters as follow are visible when the option is greater than 0:

Parameter “Fan”

This parameter is for setting status of fan speed. Options:

- OFF**
- Low**
- Medium**
- High**
- Unchange**

This parameter as follow is not visible when OFF is selected:

Parameter “Heat recovery”

This parameter is visible when heat recovery function is enabled. Setting status of heat recovery. Options:

- OFF**
- ON**
- Unchange**



5.5.3.Parameter window “Audio control”

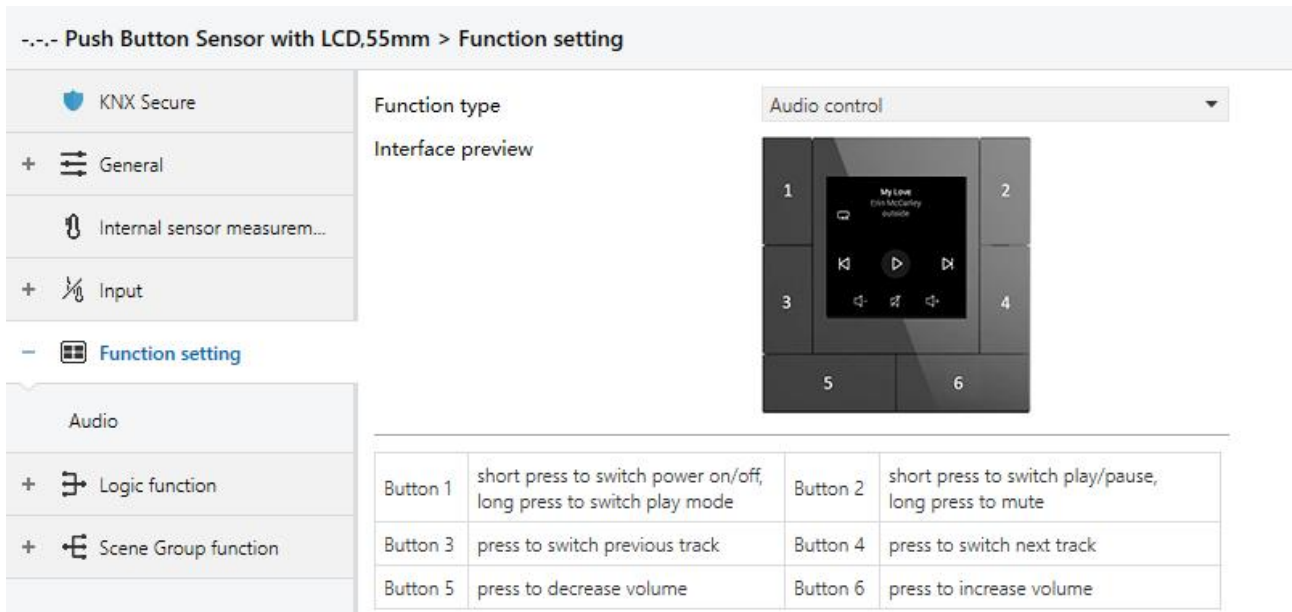

Fig.5.5.3(1) “Function setting”-“Audio control” parameter window

When “Audio control” is selected, this window displays the corresponding button operation of audio control, specific UI please refer to chapter 7.3.

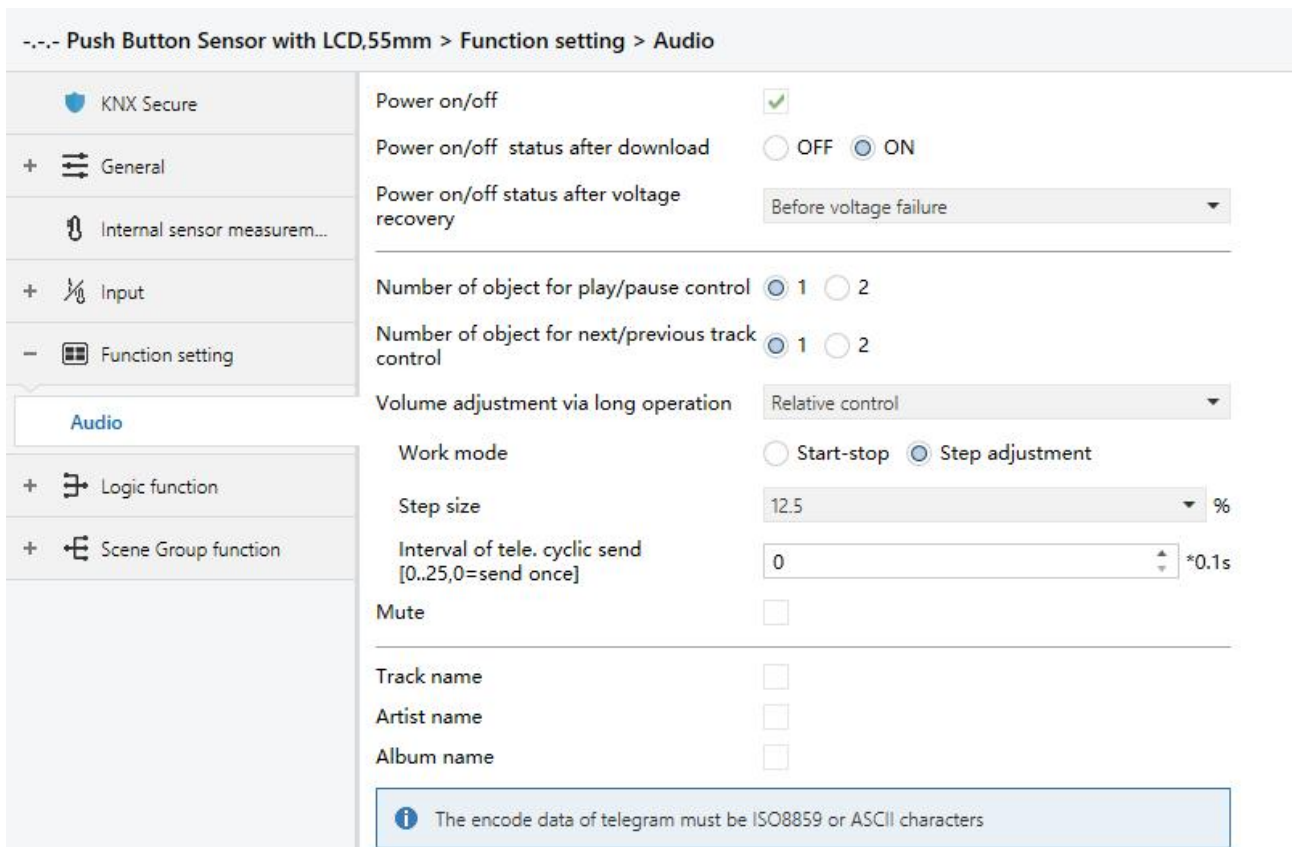

Fig.5.5.3(2) “Audio control” parameter window

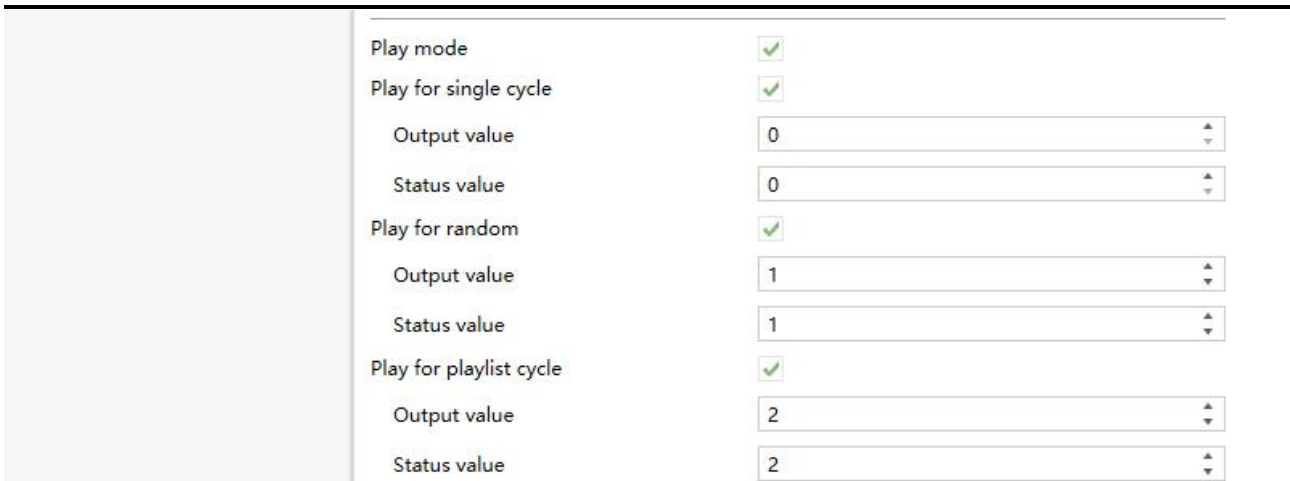

Fig.5.5.3(2) "Audio control" parameter window

#### Parameter "Power on/off"

This parameter is for setting whether to activate the function to power on/off.

If power on/off is enabled, you can set the initial status after voltage recovery or download.

If power on/off is disabled, the audio interface is always on.

Icon of power on/off on the screen is not visible when disabled. These two parameters as follow are visible when enabled:

#### Parameter "Power on/off after download"

This parameter is for setting the power on/off status of audio control interface after download. Options:

**OFF**

**ON**

#### Parameter "Power on/off after voltage recovery"

This parameter is for setting the power on/off status of audio control interface after device voltage recovery.

Options:

**OFF**

**ON**

**Before voltage failure**

On: device will power on when voltage recovery, this interface can be operated;

Off: device will power off when voltage recovery, this interface can not be operated;

Before voltage failure: device will return to the power status as before voltage failure when voltage recovery.

Parameter “Number of object for play/pause control”

This parameter is for setting the number of objects that control play/pause, 1 common object or 2 separate objects. Options:

**One object**

**Two objects**

Parameter “Number of object for next/previous track control”

This parameter is for setting the number of objects that control next/previous track, 1 common object or 2 separate objects. Options:

**One object**

**Two objects**

Parameter “Volume adjustment via long operation”

This parameter is for setting control type of volume adjustment via long operation. Options:

**Disable**

**Relative control**

**Absolute control**

Disable: no long operation when disabled.

Relative control: long operation and release to send 4bit and stop telegrams;

Absolute control: long operation to send absolute volume telegrams, and no telegram to send when release

Short press to send 1bit telegram.

No matter relative or absolute control, the volume displaying on the screen is only related to the telegrams from bus, it can not be updated by long operation, as well as short operation.

The parameter as follow is visible when “Relative control” is selected:

—Parameter “Work mode”

This parameter is for setting work mode of relative control. Options:

**Start-stop**

**Step adjustment**

—Parameter “Step size”

This parameter is for setting the step size of relative adjustment.

When “Start-stop” is selected, option is only **100%**

When “Step adjustment” is selected, options:

**100%**

**50%**

...

**3.13%**

**1.56%**

E.g. step size is 50%, telegram value is: increase is 10 and decrease is 2, similar to relative dimming telegrams.

These three parameter as follow are visible when “Absolute control” is selected:

—Parameter “Object datatype”

This parameter is for setting the object datatype of absolute adjustment. Options:

**Percentage (DPT 5.001)**

**Percentage (DPT 5.004)**

—Parameter “Step size [1..10]”

This parameter is for setting the step size of absolute adjustment. Options: **1..10**

E.g. current volume is 10%, the step size is 5%, then after adjusting once, the output volume will be 15%.

—Parameter “Max. volume value [10..100]”

This parameter is for setting the maximum volume value. Options: **10..100**

—Parameter “Interval of tele. cyclic send [0..25,0=send once]”

This parameter is for setting the time interval of cyclical volume adjustment telegram sent via long operation.

Options: **0..25,0=send once**

The time interval is default as **0** when relative control and “Start-stop” is selected.

Parameter “Mute”

This parameter is for setting whether to enable mute function.

Parameter “Track name”

This parameter is for setting whether to display the track name.

Parameter “Artist name”

This parameter is for setting whether to display the artist name.

#### Parameter "Album name"

This parameter is for setting whether to display the album name.

**i** The encode data of telegram must be UTF-8 or ASCII characters

**i** The encode data of telegram must be ISO8859 or ASCII characters

**Note:** The encode data of track name, artist name and album name telegram is associated with interface language, when it is selected Chinese, use UTF-8 or ASCII; while other languages, use ISO8859 or ASCII.

#### Parameter "Play mode"

This parameter is for setting whether to enable play mode, display the parameters as follow when enabled.

#### **Play for single cycle/random play/playlist cycle**

##### **—Parameter "Output value"**

This parameter is for setting the output value of each play mode. Options: **0..255**

##### **—Parameter "Status value"**

This parameter is for setting the status value of each play mode. Device will be updated the play mode displayed on the screen according to the feedback value. Options: **0..255**

## 5.6. Parameter window “Logic”

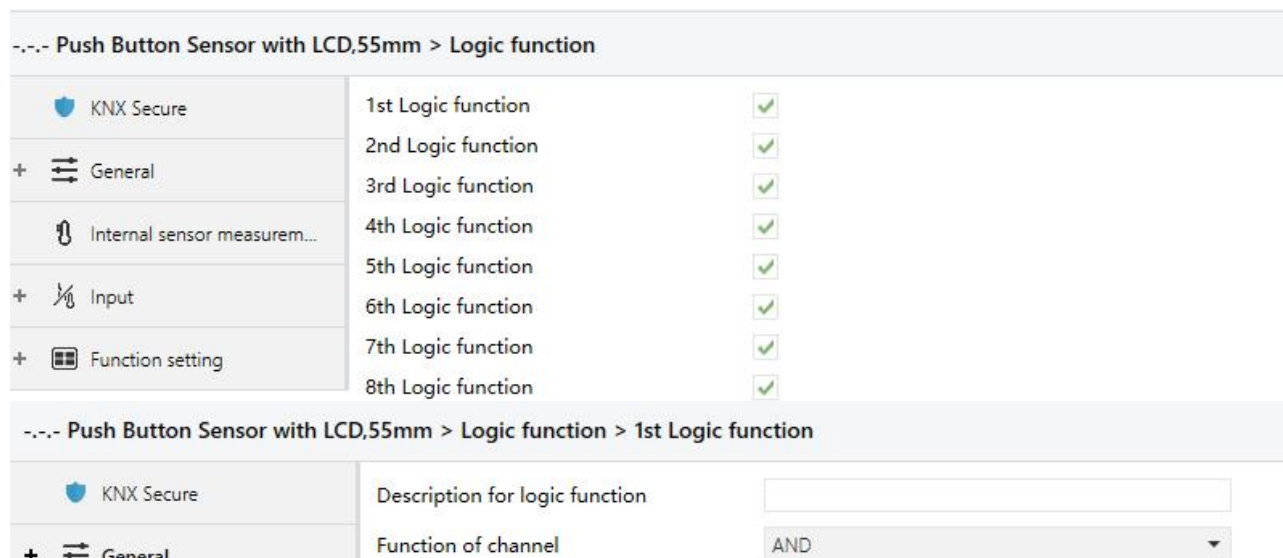

Fig.5.6 “Logic function setting” parameter window

### Parameter “1st/2nd/3rd... Logic function”

This parameter is for setting the setting interface of logic function, display corresponding logic function page when select. Up to enable 8 logic functions.

### Parameter “Description for logic function”

This parameter is for setting the name description for logic function, up to input 30 characters.

### Parameter “Function of channel”

This parameter is for setting function of the channel. Options:

**AND**

**OR**

**XOR**

**Gate forwarding**

**Threshold comparator**

**Format convert**

**Gate function**

**Delay function**

**Staircase lighting**

AND/OR/XOR: as the parameter is similar to the communication object (only the logic algorithm is different), the following parameters taking one options for example.

**5.6.1. Parameter window “AND/OR/XOR”**

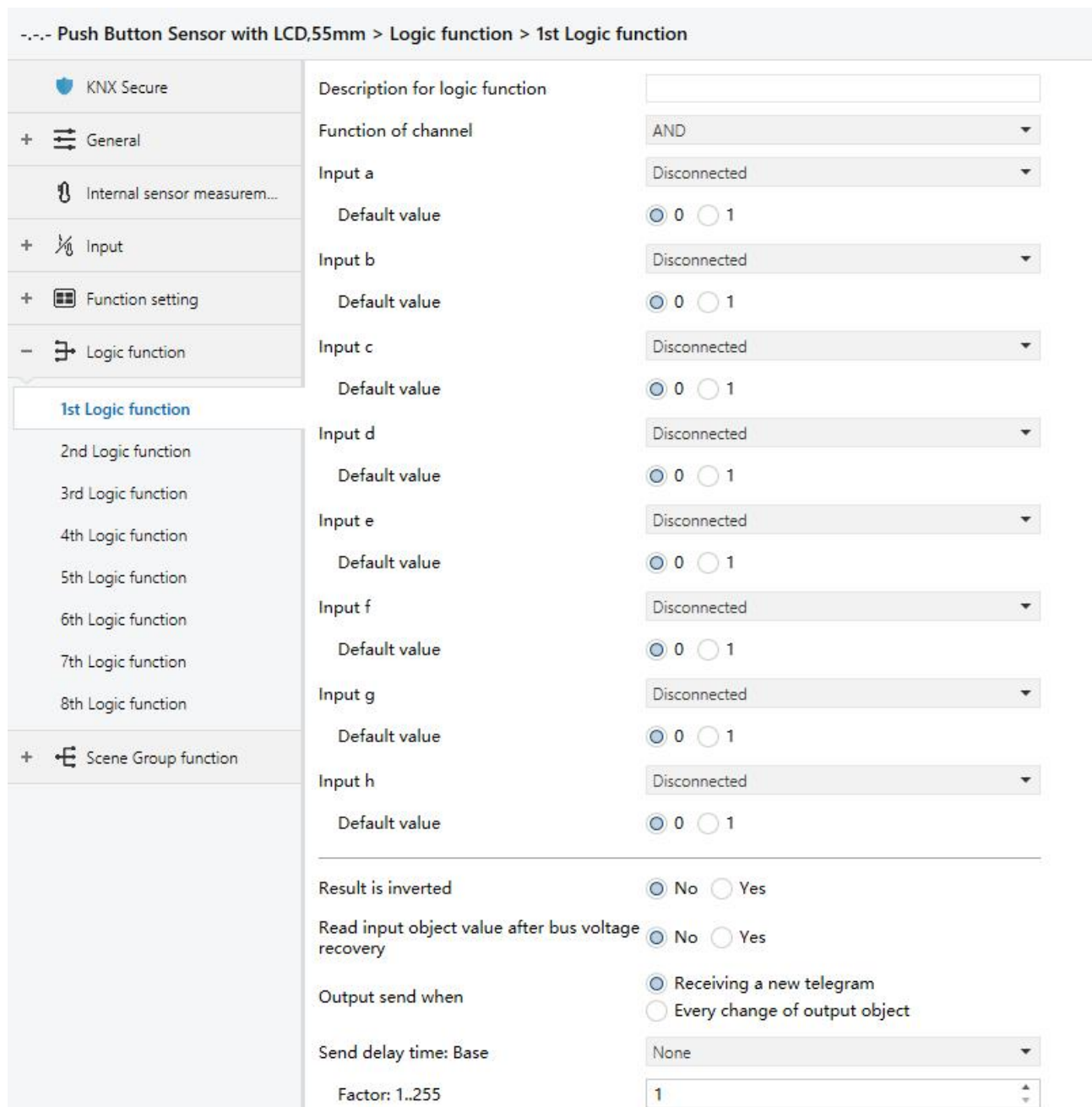

Fig.5.6.1 “AND/OR/XOR” parameter window

**Parameter “Input a/b/c/d/e/f/g/h”**

This parameter is for setting whether input x to calculate, whether to normally calculate or inverted calculate. Options:

**Disconnected**

**Normal**

### **Inverted**

Disconnected: not to calculate;

Normal: to directly calculate the input value;

Inverted: invert the input value, then to calculate. **Note: not to invert the initiate value.**

#### Parameter "Default value"

This parameter is for setting the initial value of logic input x. Options:

**0**

**1**

#### Parameter "Result is inverted"

This parameter is for setting whether to invert the logic calculation result. Options:

**No**

**Yes**

No: output directly;

Yes: output after inverting.

#### Parameter "Read input object value after voltage recovery"

This parameter is for setting whether to send the read request to the logic input object after device voltage recovery or finish programming. Options:

**No**

**Yes**

#### Parameter "Output send when"

This parameter is for setting the condition of sending logic result. Options:

**Receiving a new telegram**

**Every change of output object**

Receiving a new telegram: every time the object received a new input value will the logic result be sent to the bus;

Every change of output object: only when logic result has changed will it be sent to the bus.

**Tip: when in the first time to logic calculate, the logic result will be sent even if it has no change.**

#### Parameter "Send delay time"

**Base:**            **None**



**0.1s**

**1s**

...

**10s**

**25s**

**Factor: 1..255**

This parameter is for setting the delay time for sending the logic calculation result to the bus. Delay time = Base × Factor, if option “None” of Base is selected, then there is no delay.

### 5.6.2.Parameter window “Gate forwarding”

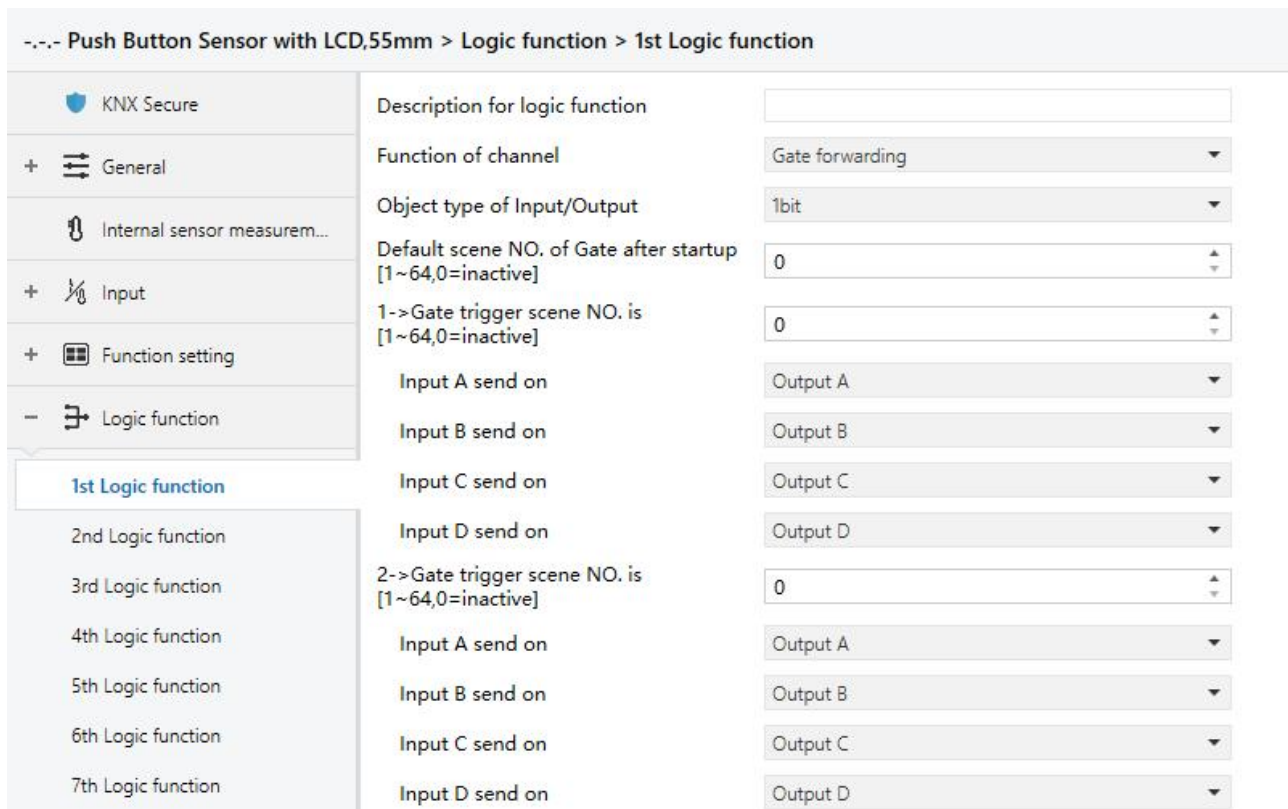

Fig.5.6.2 “Gate forwarding” parameter window

#### Parameter “Object type of Input/Output”

This parameter is for setting the object type of input/output. Options:

**1bit**

**4bit**

**1byte**

Parameter "Default scene NO. of Gate after startup [1-64,0=inactive]"

This parameter is for setting the initial scene where logical gate forwarding can be performed by default after device starts, which needs to be configured in the parameters. Options: **1..64, 0=inactive**

**Note: gate scene is recommended to be selected before operating, or it will enable the initiate scene by default.**

Parameter "z->Gate trigger scene NO. is [1-64,0=inactive]" (z=1-8)

This parameter is for setting scene number of logic gate forwarding. Up to 8 trigger scene number can be set for each logic. Options: **1..64, 0=inactive**

Parameter "Input A/B/C/D send on"

This parameter is for setting the output of input X (X=A/B/C/D) after gate forwarding. Options:

**Output A**

**Output B**

...

**Output B,C,D**

According to the options, one input can be forwarded into one or more outputs, the output value is the same as the input value.

**5.6.3. Parameter window “Threshold comparator”**

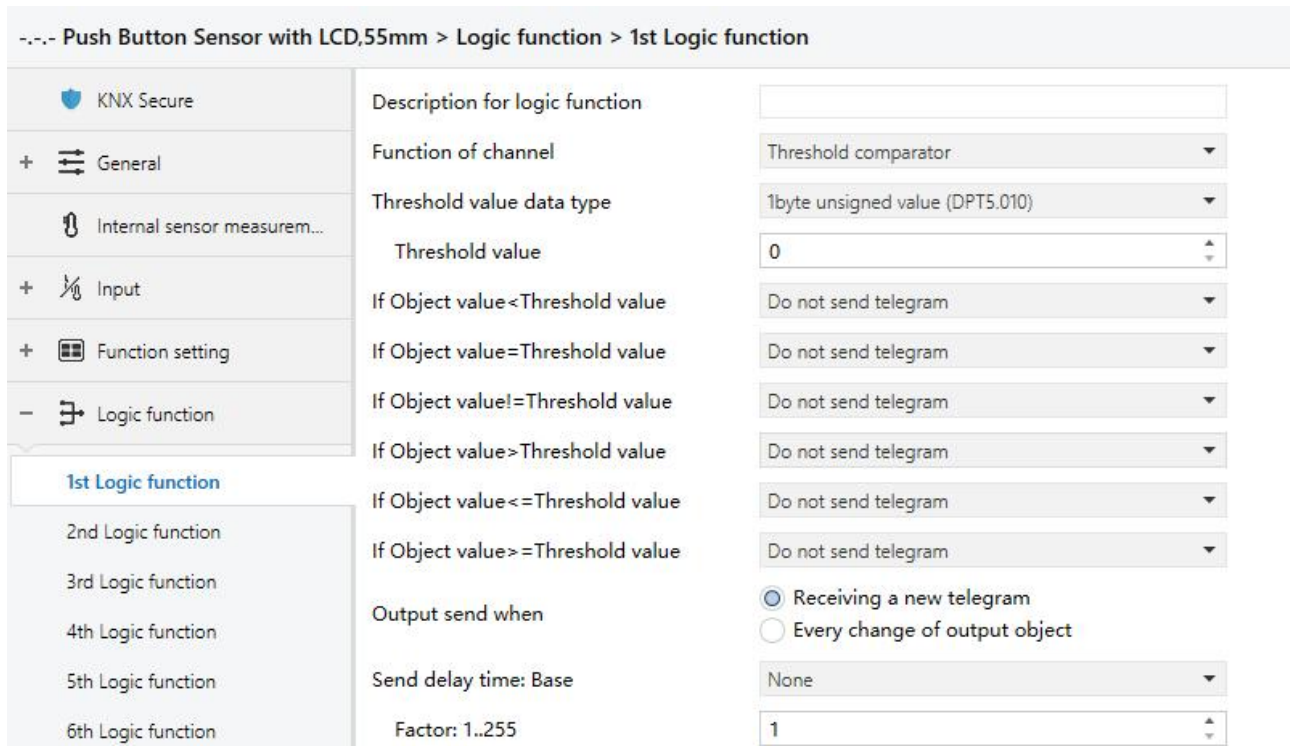

Fig.5.6.3 “Threshold comparator” parameter window

**Parameter “Threshold value data type”**

This parameter is for setting the threshold value data type. Options:

- 4bit value (DPT3.007)**
- 1byte unsigned value (DPT5.010)**
- 2byte unsigned value (DPT7.001)**
- 2byte signed value (DPT8.x)**
- 2byte float value (DPT9.x)**
- 4byte unsigned value[0..4294967295]**
- Ext. temperature value (DPT 9.001)**
- Ext. humidity value (DPT 9.007)**
- Illuminance value (DPT 9.004)**

**Parameter “Threshold value ”**

This parameter is for setting threshold value, the range depends on the data type. Options:

- 4bit value (DPT3.007) 0..15 / 1byte unsigned value (DPT5.010) 0..255 /**
- 2byte unsigned value (DPT7.001) 0..65535 / 2byte signed value (DPT8.x) -32768..32767 /**
- 2byte float value (DPT9.x) -670760...670760 / 4byte unsigned value[0..4294967295] 0..4294967295 /**
- Ext. temperature value (DPT 9.001) -20..95°C / Ext. humidity value (DPT 9.007) 0..100% /**
- Illuminance value (DPT 9.004) 0..65535lux**

Parameter "Hysteresis threshold value"

This parameter is visible when object datatype is selected "2byte float value (DPT9.x)", "Illuminance value (DPT 9.004)". Set the hysteresis threshold value. Options: **0..500**

Parameter "If Object value<Threshold value"

**Parameter "If Object value=Threshold value"**

**Parameter "If Object value!=Threshold value"**

**Parameter "If Object value>Threshold value"**

**Parameter "If Object value<=Threshold value"**

**Parameter "If Object value>=Threshold value"**

This parameter is for setting the logic result value that should be sent when threshold value less than, equal to, not equal to, greater than, less than or equal to the setting valve. When object datatype is selected "2byte float value (DPT9.x)", can only set the object value less than or greater than threshold value. Options:

**Do not send telegram**

**Send value "0"**

**Send value "1"**

Do not send telegram: not consider to select this option;

Send value "0"/"1": when condition is satisfied, send telegram 0 or 1.

If there is a conflict between the setting options between parameters, the base on the value that should be sent when reach the final parameter condition. **For example: parameter "If Object value=Threshold value" is set to be "Send value "0" "; parameter "If Object value<=Threshold value" is set to be "Send value "1" "; when object value is equal to the threshold value, then the logic result will send "1".**

Parameter "Output send when"

This parameter is for setting the condition of sending logic result. Options:

**Receiving a new telegram**

**Every change of output object**

Receiving a new telegram: every time the object received a new input value will the logic result be sent to the bus;

Every change of output object: only when logic result has changed will it be sent to the bus.

**Tip:** when in the first time to logic algorithm, the logic result will be sent even if it has no change.

Parameter "Send delay time"

**Base:**           None  
                   0.1s  
                   1s  
                   ...  
                   10s  
                   25s

**Factor:**       1..255

This parameter is for setting the delay time for sending the logic algorithm result to the bus. Delay time = Base x Factor, if option "None" of Base is selected, then there is no delay.

**5.6.4. Parameter window "Format convert"**

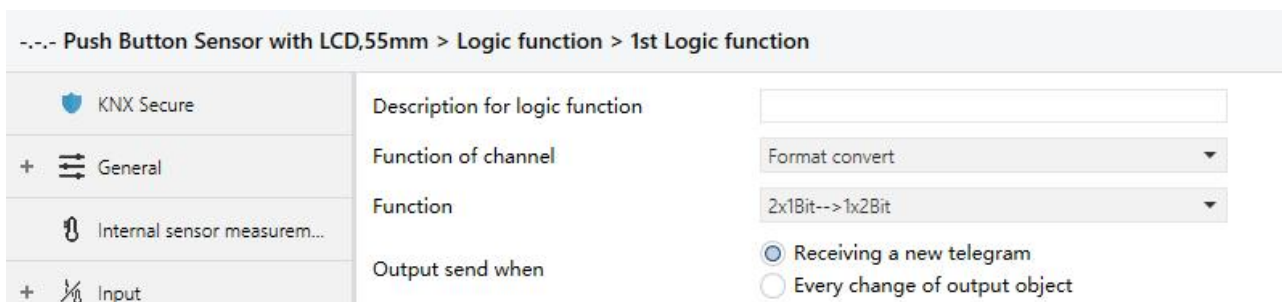

Fig.5.6.4 "Format convert" parameter window

Parameter "Function"

This parameter is for setting the format convert type. Options:

- 2x1bit-->1x2bit**
- 8x1bit-->1x1byte**
- 1x1byte-->1x2byte**
- 2x1byte-->1x2byte**
- 2x2byte-->1x4byte**
- 1x1byte-->8x1bit**
- 1x2byte-->2x1byte**
- 1x4byte-->2x2byte**

1x3byte-->3x1byte

3x1byte-->1x3byte

Parameter “Output send when”

This parameter is for setting the condition of sending logic result. Options:

**Receiving a new telegram**

**Every change of output object**

Receiving a new telegram: every time the object received a new input value will the logic result be sent to the bus;

Every change of output object: only when logic result has changed will it be sent to the bus.

**Tip: when in the first time to logic algorithm, the logic result will be sent even if it has no change.**

5.6.5.Parameter window “Gate function”

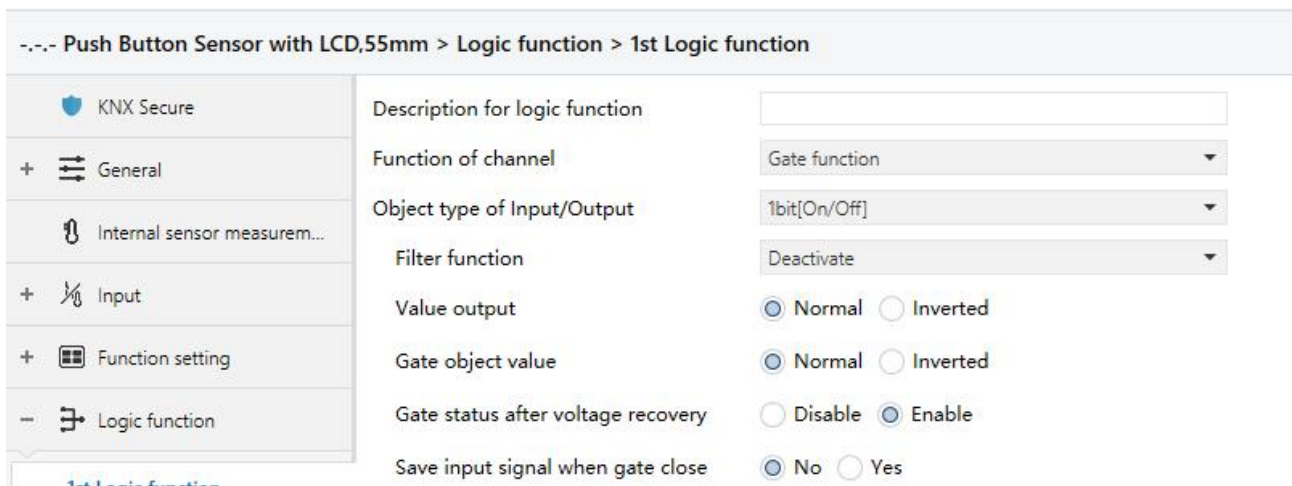

Fig.5.6.5 “Gate function” parameter window

Parameter “Object type of Input/Output”

This parameter is for setting the object type of input/output. Options:

**1bit[On/Off]**

**1byte[0..100%]**

**1byte[0..255]**

**2byte[Float]**

**2byte[0..65535]**

Parameter "Filter function"

This parameter is visible when "1bit[On/Off]" is selected. Set whether to filter On or Off telegram, only pass one of them or pass all. Options:

**Deactivate**

**On filter out**

**Off filter out**

Deactivate: Do not filter the On or Off telegrams;

On filter out: Off can pass, On cannot pass;

Off filter out: On can pass, Off cannot pass.

Parameter "Value output"

This parameter is visible when "1bit[On/Off]" is selected. Set whether to invert the value then output it. Options:

**Normal**

**Inverted**

Parameter "Gate object value"

This parameter is for setting whether to invert the gate object value then output it. Options:

**Normal**

**Inverted**

Parameter "Gate status after voltage recovery"

This parameter is for setting the gate status after voltage recovery. Options:

**Disable**

**Enable**

Parameter "Save input signal when gate close"

This parameter is for setting whether to save input signal on gate close. Options:

**No**

**Yes**

No: disable to save the input, the input values received during the gate closing period are ignored;

Yes: enable to save the input, the input values received during the gate closing period are output when gate is open (whether the input value is changed or not).

### 5.6.6. Parameter window “Delay function”

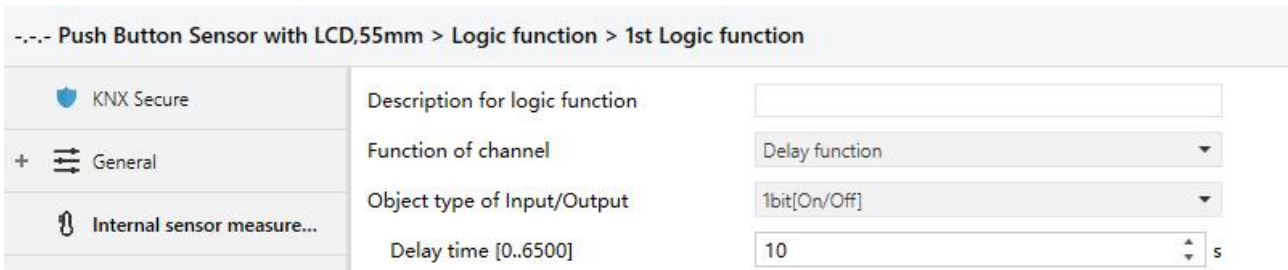

Fig.5.6.6 “Delay function” parameter window

#### Parameter “Object type of Input/Output”

This parameter is for setting the object type of input/output. Options:

**1bit[On/Off]**

**1byte[0..100%]**

**1byte[0..255]**

**2byte[Float]**

**2byte[0..65535]**

#### Parameter “Delay time [0..6500]s”

This parameter is for setting the delay time that output object forwards the value when the input object receives the telegram. Options: **0..6500**

**Note: Receive telegram again in delay time, re-timing.**

### 5.6.7. Parameter window “Staircase lighting”

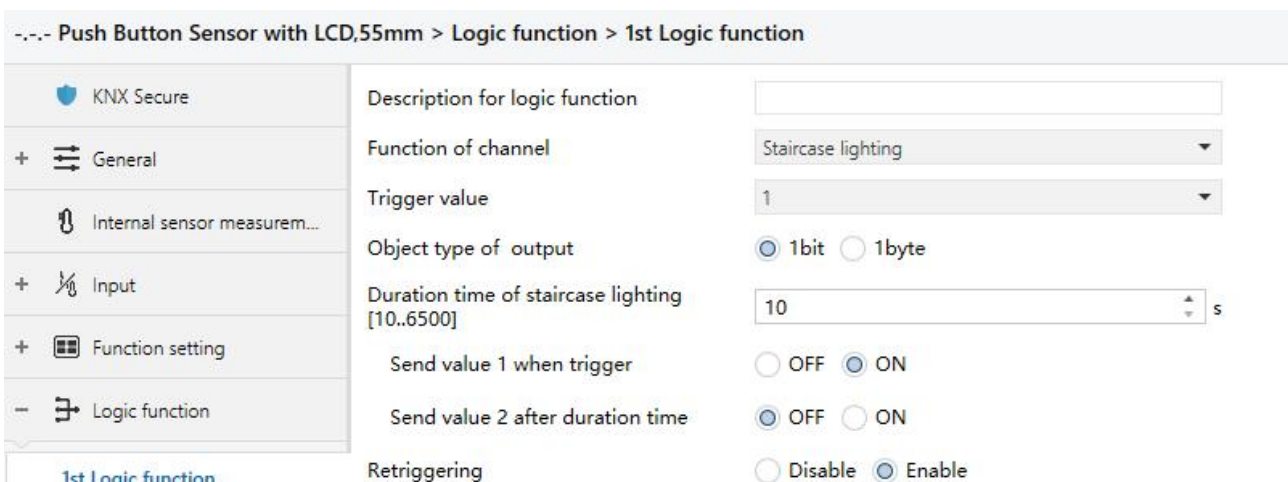

Fig.5.6.7 “Staircase lighting” parameter window



Parameter “Trigger value”

This parameter is for setting the telegram value of the object “Trigger value”. Options:

**0**

**1**

**0 or 1**

Parameter “Object type of output”

This parameter is for setting the object type of output. Options:

**1bit**

**1byte**

Parameter “Duration time of staircase lighting[10..6500]s”

This parameter is for setting duration time of staircase lighting after the stair light power on.

Options: **10..6500**

—Parameter “Send value 1 when trigger”

—Parameter “Send value 2 after duration time”

These parameters are for setting the value to send. Send value 1 when trigger, and then send value 2 after duration time. Options display according to the output object datatype.

When 1 bit, options:

**OFF**

**ON**

When 1 byte , options: **0..255**

Parameter “Retriggering”

This parameter is for setting whether to trigger re-timing when received trigger value in delay time. Options:

**Disable**

**Enable**

## 5.7. Parameter window “Scene Group”

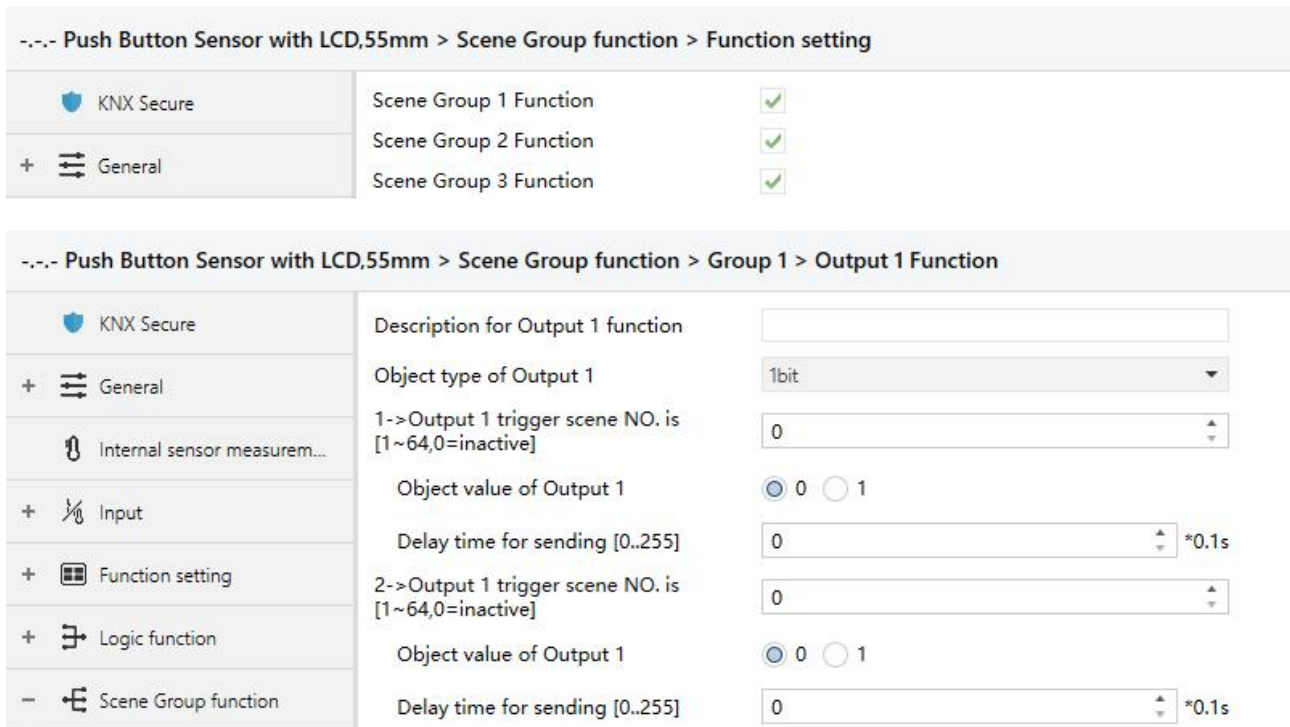

Fig.5.7 “Scene Group” parameter window

### Parameter “Scene Group x Function”(x=1-8)

This parameter is for setting whether to enable scene group x function, up to 8 scene groups.

### Parameter “Output y Function”(y=1-8)

This parameter is for setting whether to enable output y of scene group x, up to 8 output functions for each scene group.

As 8 group functions are the same, and 8 output functions of each group as well, the following description only about one output of a group.

### Parameter “Description for Output y function”(y=1-8)

This parameter is for setting the name description for output y of group x, up to input 30 characters.

### Parameter “Object type of Output y”(y=1-8)

This parameter is for setting the object type of output y of group x. Options:

**1bit**

**1byte**

**2byte**

Parameter "Object datatype"

This parameter is for setting the datatype of 1byte or 2byte.

When the datatype is 1byte, options:

**1byte unsigned value**

**HVAC mode**

When the datatype is 2byte, options:

**2byte unsigned value**

**Temperature value**

Parameter "z->Output y trigger scene NO. is [1-64,0=inactive]" (z=1-8)

This parameter is for setting the triggered scene number of output y of group x. Up to 8 triggered scene of each output can be configured. Options: **0..64, 0=inactive**

Parameter "Object value of Output y"

This parameter is for setting the output value, the range depends on the data type of output y.

When the datatype is 1bit, options: **0..1**

When the datatype is 1byte-1byte unsigned value, options: **0..255**

When the datatype is 1byte-HVAC mode, options:

**Comfort mode**

**Standby mode**

**Economy mode**

**Frost/heat protection**

When the datatype is 2byte-2byte unsigned value, options: **0..65535**

When the datatype is 2byte-Temperature value, options:

**-5°C**

**-4°C**

**...**

**45°C**

Parameter "Delay time for sending [0..255]\*0.1s"

This parameter is for setting the delay time for sending the output value to the bus. Options: **0..255**

## Chapter 6 Description of Communication Object

The communication object is the medium to communicate other device on the bus, namely only the communication object can communicate with the bus.

**NOTE:** “C” in “Flag” column in the below table means enable the communication function of the object; “W” means value of object can be written from the bus; “R” means the value of the object can be read by the other devices; “T” means the object has the transmission function; “U” means the value of the object can be updated.

### 6.1. “General” Communication Object

Number	Name	Object Function	Description	Group Address	Length	C	R	W	T	U	Data Type	Priority
1	General	In operation			1 bit	C	R	-	T	-	switch	Low
2	General	Date			3 bytes	C	-	W	-	-	date	Low
3	General	Time			3 bytes	C	-	W	-	-	time of day	Low
4	General	Screen brightness			1 byte	C	-	W	-	-	percentage (0..100%)	Low
345	Extension function	Panel locking			1 bit	C	-	W	-	-	enable	Low
347	Extension function	Night mode			1 bit	C	R	-	T	-	day/night	Low
349	Extension function	Dis/En Proximity function			1 bit	C	-	W	-	-	enable	Low
350	Extension function	Proximity input			1 bit	C	-	W	-	-	switch	Low
351	Extension function	Proximity output			1 bit	C	-	-	T	-	switch	Low
352	Extension function	Alarm acknowledge			1 bit	C	-	-	T	-	acknowledge	Low
353	Extension function	Alarm message			14 bytes	C	-	W	-	-	Character String (ISO 8859-1)	Low
354	Extension function	Alarm input			1 bit	C	-	W	T	U	alarm	Low
355	Extension function	Locking scene			1 byte	C	-	-	T	-	scene number	Low
356	Screensaver-Items 1	Temperature value			2 bytes	C	-	W	T	U	temperature (°C)	Low
357	Screensaver-Items 2	Humidity value			2 bytes	C	-	W	T	U	humidity (%)	Low

Fig.6.1 “General” communication Object

NO.	Object Function	Name	Data Type	Flag	DPT
1	In operation	General	1bit	C,R,T	1.001 switch
The communication object is used to periodically send a telegram “1” to the bus to indicate this device in normal operation. The period is set by the parameter.					
2	Date	General	3byte	C,W	11.001 date
The communication object is used to modify the display date through the bus.					
3	Time	General	3byte	C,W	10.001 time of day
The communication object is used to modify the display time through the bus.					
4	Screen brightness	General	1byte	C,W	5.001 percentage(0..100%)
The communication object is used to modify the brightness of current mode. For example, if current is normal mode, it is only updated the brightness in normal mode, while night mode it is still determined to its parameter. Note: brightness in screen saver can not be modified via the object. Brightness range: 20~100%, when telegram is below 20%, output 20% directly.					

<b>345</b>	<b>Panel locking</b>	<b>Extension function</b>	<b>1bit</b>	<b>C,W</b>	<b>1.003 enable</b>
<p>The communication object is used to lock the panel. After screen is locked, the operation on the panel will not be responded, but can still receive the bus telegram. Telegram value is defined by the parameter.</p>					
<b>346</b>	<b>Screen on/off</b>	<b>Extension function</b>	<b>1bit</b>	<b>C,W</b>	<b>1.001 switch</b>
<p>The communication object is used to receive the telegrams from bus to control screen on/off. Telegram value:</p> <p>0 — Off</p> <p>1 — On</p>					
<b>347</b>	<b>Night mode</b>	<b>Extension function</b>	<b>1bit</b>	<b>C,R,T</b> <b>C,W,T,U</b>	<b>1.024 day/night</b>
<p>This communication object is used to send day/night status to the bus. Telegram value:</p> <p>0 — Day</p> <p>1 — Night</p> <p>The object flag is C,R,T when the day/night status is switched according to the time point or sunrise and sunset time, can not receive the telegram value via bus to switch;</p> <p>The object flag is C,W,T,U when the day/night status is switched according to the object, receive the telegram value via bus to switch. If device restart, the object sends status request telegram (if sending parameter is enabled in General interface).</p>					
<b>348</b>	<b>Summer time status</b>	<b>Extension function</b>	<b>1bit</b>	<b>C,R,T</b>	<b>1.003 enable</b>
<p>The communication object is used to send the status telegrams of the summer time to the bus. Telegrams:</p> <p>1 — Summer time enable</p> <p>0 — Summer time disable</p>					
<b>349</b>	<b>Dis/En Proximity function</b>	<b>Extension function</b>	<b>1bit</b>	<b>C,W</b>	<b>1.003 enable</b>
<p>The communication object is used to enable/disable proximity function.</p>					
<b>350</b>	<b>Proximity input</b>	<b>Extension function</b>	<b>1bit</b>	<b>C,W</b>	<b>1.001 switch</b>
<p>The communication object is visible when proximity function is triggered by the object. Receive the telegram value from bus:</p> <p>1 — Trigger proximity function</p> <p>0 — No available</p>					

351	Proximity output	Extension function	1bit 1byte 2byte	C,T	1.001 switch 5.010 counter pulses 17.001 scene number 5.001 percentage 7.001 pulses
<p>The communication object is determined by the parameter “Object type of output value”. When proximity function is triggered, the object can send the parameter setting value(1byte/2byte) or ON(1bit ) to the bus separately. The range of value is determined by the selected data type.</p>					
352	Alarm acknowledge	Extension function	1bit	C,T	1.016 acknowledge
<p>When the user acknowledges the warning message on the screen, the communication object sends an acknowledge telegram to the bus, and the telegram value is 1.</p>					
353	Alarm message	Extension function	14byte	C,W	16.001 character string (ISO 8859-1)
<p>The communication object is used to receive the warning message displayed on the screen from bus. When no value is received initially, the warning pop-up is displayed empty.</p>					
354	Alarm input	Extension function	1bit	C,W,T,U	1.005 alarm
<p>The communication object is used to receive the alarm signal from bus. Telegram value:</p> <p>0 —— No alarm</p> <p>1 —— Alarm</p> <p>If device restart, the object sends status request telegram (if sending parameter is enabled in General interface).</p>					
355	Locking scene	Extension function	1byte	C,T	17.001 scene number
<p>The communication object is visible when panel locking function and external scene function are enabled. Used to recall external scene command.</p>					
356	PM2.5/PM10/VOC value	Screensaver-Items 1	2byte	C,W,T,U	7.001 pulse 9.030 concentration(ug/m3)
<p>The communication object is used to receive the measurement value of the PM2.5/PM10/VOC value and get the corresponding value from the bus to be updated to the display in ug/m<sup>3</sup>. Range: 0~999ug/m<sup>3</sup>, object datatype is determined by the parameter setting.</p> <p>If device restart, the objects send status request telegram (if sending parameter is enabled in General interface). The other objects of screen saver are the same.</p>					
356	Temperature value	Screensaver-Items 1	2byte	C,W,T,U	9.001 temperature

<p>The communication object is used for receiving a temperature measurement value sent from a external temperature sensor, the corresponding value got from the bus is updated to screen display.</p> <p>Range: -40...40°C</p>					
356	Humidity value	Screensaver-Items 1	2byte	C,W,T,U	9.007 humidity
<p>The communication object is used for receiving a humidity measurement value sent from a external humidity sensor, the corresponding value got from the bus is updated to screen display. Range: 0~100%</p>					
356	CO2 value	Screensaver-Items 1	2byte	C,W,T,U	7.001 pulse 9.008 parts/million(ppm)
<p>The communication object is used to receive the measurement value of the CO2 value and get the corresponding value from the bus to be updated to the display in ppm. Range: 0~4000ppm, object datatype is determined by the parameter setting.</p>					
356	Brightness value	Screensaver-Items 1	2byte	C,W,T,U	7.013 brightness(lux) 9.004 lux
<p>The communication object is used to receive the measurement value of the brightness value and get the corresponding value from the bus to be updated to the display in lux. Range: 0~65535lux, object datatype is determined by the parameter setting.</p>					
356	Wind speed	Screensaver-Items 1	2byte	C,W,T,U	9.005 speed 9.028 wind speed
<p>The communication object is used to receive the measurement value of the wind speed value and get the corresponding value from the bus to be updated to the display in m/s or km/h. Object datatype is determined by the parameter setting.</p>					
356	AQI value	Screensaver-Items 1	2byte	C,W,T,U	7.001 pulse
<p>The communication object is used to receive the measurement value of the AQI value and get the corresponding value from the bus to be updated to the display. Range: 0~500</p>					

Table 6.1 “General” communication object table

## 6.2. “Internal sensor measurement” Communication Object

Number	Name	Object Function	Description	Group Address	Length	C	R	W	T	U	Data Type	Priority
5	Internal sensor	Temperature value			2 bytes	C	R	-	T	-	temperature (°C)	Low
6	Internal sensor	Low temperature alarm			1 bit	C	R	-	T	-	alarm	Low
7	Internal sensor	High temperature alarm			1 bit	C	R	-	T	-	alarm	Low
8	Internal sensor	Humidity value			2 bytes	C	R	-	T	-	humidity (%)	Low
9	Internal sensor	Low humidity alarm			1 bit	C	R	-	T	-	alarm	Low
10	Internal sensor	High humidity alarm			1 bit	C	R	-	T	-	alarm	Low

Fig.6.2 “Internal sensor measurement” communication Object

NO.	Object Function	Name	Data Type	Flag	DPT
5	Temperature value	Internal sensor	2byte	C,R,T	9.001 temperature
The communication object is used for transmitting the temperature value detected by the built-in temperature sensor of the device to the bus. Range:-50~99.8°C					
6	Low temperature alarm	Internal sensor	1bit	C,R,T	1.005 alarm
The communication object is used to send the low temperature alarm signal to bus, when temperature lower than low threshold that defined by parameter.					
7	High temperature alarm	Internal sensor	1bit	C,R,T	1.005 alarm
The communication object is used to send the high temperature alarm signal to bus, when temperature higher than high threshold that defined by parameter.					
8	Humidity value	Internal sensor	2byte	C,R,T	9.007 humidity
The communication object is used to receive humidity measurements sent from the humidity sensor on the bus. Range:0~100%					
9	Low humidity alarm	Internal sensor	1bit	C,R,T	1.005 alarm
The communication object is used to send the low humidity alarm signal to bus, when humidity lower than low threshold that defined by parameter.					
10	High humidity alarm	Internal sensor	1bit	C,R,T	1.005 alarm
The communication object is used to send the high humidity alarm signal to bus, when humidity higher than high threshold that defined by parameter.					

Table 6.2 “Internal sensor measurement” communication object table



### 6.3. “Input” Communication Object

Number	Name	Object Function	Description	Group Address	Length	C	R	W	T	U	Data Type	Priority
244	Input 1 - Temperature probe	Actual temperature, Sensor			2 bytes	C	R	-	T	-	temperature (°C)	Low
245	Input 1 - Temperature probe	Temperature error report, Sensor			1 bit	C	R	-	T	-	alarm	Low
Temperature probe												
Number	Name	Object Function	Description	Group Address	Length	C	R	W	T	U	Data Type	Priority
244	Input 1 - Switch sensor	Switch			1 bit	C	R	W	T	U	switch	Low
244	Input 1 - Switch sensor	Close, Switch			1 bit	C	R	W	T	U	switch	Low
245	Input 1 - Switch sensor	Open, Switch			1 bit	C	R	W	T	U	switch	Low
244	Input 1 - Switch sensor	Short, Switch			1 bit	C	R	W	T	U	switch	Low
245	Input 1 - Switch sensor	Long, Switch			1 bit	C	R	W	T	U	switch	Low
246	Input 1 - Switch sensor	Disable			1 bit	C	-	W	-	-	enable	Low
BI: Switch sensor												
Number	Name	Object Function	Description	Group Address	Length	C	R	W	T	U	Data Type	Priority
244	Input 1 - Scene control	Scene			1 byte	C	-	-	T	-	scene control	Low
244	Input 1 - Scene control	Close, Scene			1 byte	C	-	-	T	-	scene control	Low
245	Input 1 - Scene control	Open, Scene			1 byte	C	-	-	T	-	scene control	Low
244	Input 1 - Scene control	Short, Scene			1 byte	C	-	-	T	-	scene control	Low
245	Input 1 - Scene control	Long, Scene			1 byte	C	-	-	T	-	scene control	Low
246	Input 1 - Scene control	Disable			1 bit	C	-	W	-	-	enable	Low
BI: Scene control												
Number	Name	Object Function	Description	Group Address	Length	C	R	W	T	U	Data Type	Priority
244	Input 1 - Send String	String			14 bytes	C	-	-	T	-	Character String (ISO 8859-1)	Low
244	Input 1 - Send String	Close, String			14 bytes	C	-	-	T	-	Character String (ISO 8859-1)	Low
245	Input 1 - Send String	Open, String			14 bytes	C	-	-	T	-	Character String (ISO 8859-1)	Low
244	Input 1 - Send String	Short, String			14 bytes	C	-	-	T	-	Character String (ISO 8859-1)	Low
245	Input 1 - Send String	Long, String			14 bytes	C	-	-	T	-	Character String (ISO 8859-1)	Low
246	Input 1 - Send String	Disable			1 bit	C	-	W	-	-	enable	Low
BI: Send string												

Fig.6.3 “Input” communication Object

NO.	Object Function	Name	Data Type	Flag	DPT
244	Actual temperature, Sensor	Input 1 - {{Temperature probe}}	2byte	C,R,T	9.001 temperature
<p>The communication object is used for transmitting the temperature value detected by the external temperature sensor of the device to the bus. Range:-50~99.8°C</p> <p>The name in parentheses changes with the parameter “Description (max 30 char.)”. If description is empty, display “Input x - ...” by default. The same below.</p>					
245	Temperature error report, Sensor	Input 1 - {{Temperature probe}}	1bit	C,R,T	1.005 alarm
<p>The communication object is used to send the error report of the external temperature sensor, and the object value is defined according to the parameters.</p>					
244	Switch	Input 1 - {{Switch sensor}}	1bit	C,R,W,T,U	1.001 switch
244	Close/Short, Switch	Input 1 - {{Switch sensor}}	1bit	C,R,W,T,U	1.001 switch
245	Open/Long, Switch	Input 1 - {{Switch sensor}}	1bit	C,R,W,T,U	1.001 switch
<p>These communication objects are used to trigger a switching operation. Use a common object or two separate objects is according to the parameter setting.</p>					

Only the object “Switch” is visible when use a common object. If use two separate objects, “Close/Open” is visible when there is no distinction for short/long operation; “Short/Long” is visible when there is distinction for short/long operation. Telegrams:

0—Off

1—On

244	Scene	Input 1 - {{Scene control}}	1byte	C,T	18.001 scene control
244	Close/Short, Scene	Input 1 - {{Scene control}}	1byte	C,T	18.001 scene control
245	Open/Long, Scene	Input 1 - {{Scene control}}	1byte	C,T	18.001 scene control

These communication objects are used to send a 8 bit command to recall or storage scene. Use a common object or two separate objects is according to the parameter setting.

Only the object “Scene” is visible when use a common object. If use two separate objects, “Close/Open” is visible when there is no distinction for short/long operation; “Short/Long” is visible when there is distinction for short/long operation.

Detailed 8bit the meaning of the directive.

Set up a 8bit Orders for the (Binary code): FXNNNNNN

F: '0' recall scene; '1' for storage scene;

X : 0 ;

NNNNNN: Scene number( 0... 63).

As follows:

Object message value	Description
0	Recall scene 1
1	Recall scene 2
2	Recall scene 3
...	...
63	Recall scene 64
128	Store scene 1
129	Store scene 2
130	Store scene 3
...	...
191	Store scene 64

Parameter setting Options are 1~64, actually communication object “Scene” corresponds to the telegram received is 0~63 . Such as parameter settings is the scene 1, communication object “Scene” sends the scene for 0.

244	String	Input 1 - {{Send String}}	14byte	C,T	16.001 character string (ISO 8859-1)
244	Close/Short, String	Input 1 - {{Send String}}	14byte	C,T	16.001 character string (ISO 8859-1)
245	Open/Long, String	Input 1 - {{Send String}}	14byte	C,T	16.001 character string (ISO 8859-1)
<p>These communication objects are used to send the sting to bus. Use a common object or two separate objects is according to the parameter setting.</p> <p>Only the object “String” is visible when use a common object. If use two separate objects, “Close/Open” is visible when there is no distinction for short/long operation; “Short/Long” is visible when there is distinction for short/long operation.</p>					
246	Disable	Input 1 - {...}	1bit	C,W	1.003 enable
<p>The communication object is used to disable/enable the function of contact input, apply to binary input function, including switch, scene and send string.</p>					

Table 6.3 “Input” communication object table

## 6.4. “Push button sensor” Communication Object

The objects of individual button are similar to the rocker button, so the repeat objects as follow are explained by individual button.

Number	Name	Object Function	Description	Group Address	Length	C	R	W	T	U	Data Type	Priority
148	Button 1 - Switching	Switch			1 bit	C	-	-	T	-	switch	Low
153	Button 1 - Switching	Switch status			1 bit	C	-	W	T	U	switch	Low
148	Button 1 - Switching	Press, Switch			1 bit	C	-	-	T	-	switch	Low
149	Button 1 - Switching	Release, Switch			1 bit	C	-	-	T	-	switch	Low
152	Button 1 - Switching	Press, switch status			1 bit	C	-	W	T	U	switch	Low
153	Button 1 - Switching	Release, switch status			1 bit	C	-	W	T	U	switch	Low
148	Button 1 - Switching	Short, Switch			1 bit	C	-	-	T	-	switch	Low
149	Button 1 - Switching	Long, Switch			1 bit	C	-	-	T	-	switch	Low
152	Button 1 - Switching	Short, switch status			1 bit	C	-	W	T	U	switch	Low
153	Button 1 - Switching	Long, switch status			1 bit	C	-	W	T	U	switch	Low
151	Button 1 - Switching	Flashing function			1 bit	C	-	W	-	U	enable	Low
154	Button 1 - Switching	Disable			1 bit	C	-	W	-	-	enable	Low
155	Button 1 - Switching	Status indication			1 bit	C	-	W	T	U	switch	Low
Switch												
Number	Name	Object Function	Description	Group Address	Length	C	R	W	T	U	Data Type	Priority
148	Button 1 - Dimming	Short, Switch			1 bit	C	-	-	T	-	switch	Low
149	Button 1 - Dimming	Long, Dimming			4 bit	C	-	W	T	-	dimming control	Low
153	Button 1 - Dimming	Switch status			1 bit	C	-	W	T	U	switch	Low
154	Button 1 - Dimming	Disable			1 bit	C	-	W	-	-	enable	Low
155	Button 1 - Dimming	Status indication			1 bit	C	-	W	T	U	switch	Low
151	Button 1 - Dimming	Flashing function			1 bit	C	-	W	-	U	enable	Low
Dimming												

Number	Name	Object Function	Description	Group Address	Length	C	R	W	T	U	Data Type	Priority
148	Button 1 - RGB	Switch			1 bit	C	-	-	T	-	switch	Low
149	Button 1 - RGB	RGB dimming value			3 bytes	C	-	-	T	-	RGB value 3x(0..255)	Low
149	Button 1 - RGB	Red dimming value			1 byte	C	-	-	T	-	percentage (0..100%)	Low
150	Button 1 - RGB	Green dimming value			1 byte	C	-	-	T	-	percentage (0..100%)	Low
151	Button 1 - RGB	Blue dimming value			1 byte	C	-	-	T	-	percentage (0..100%)	Low
153	Button 1 - RGB	Switch status			1 bit	C	-	W	T	U	switch	Low
154	Button 1 - RGB	Disable			1 bit	C	-	W	-	-	enable	Low
155	Button 1 - RGB	Status indication			1 bit	C	-	W	T	U	switch	Low
RGB switching/send value												
Number	Name	Object Function	Description	Group Address	Length	C	R	W	T	U	Data Type	Priority
148	Button 1 - RGBW	Switch			1 bit	C	-	-	T	-	switch	Low
149	Button 1 - RGBW	RGBW dimming value			6 bytes	C	-	-	T	-	RGBW value 4x(0..100%)	Low
149	Button 1 - RGBW	Red dimming value			1 byte	C	-	-	T	-	percentage (0..100%)	Low
150	Button 1 - RGBW	Green dimming value			1 byte	C	-	-	T	-	percentage (0..100%)	Low
151	Button 1 - RGBW	Blue dimming value			1 byte	C	-	-	T	-	percentage (0..100%)	Low
152	Button 1 - RGBW	White dimming value			1 byte	C	-	-	T	-	percentage (0..100%)	Low
153	Button 1 - RGBW	Switch status			1 bit	C	-	W	T	U	switch	Low
154	Button 1 - RGBW	Disable			1 bit	C	-	W	-	-	enable	Low
155	Button 1 - RGBW	Status indication			1 bit	C	-	W	T	U	switch	Low
RGBW switching/send value												
Number	Name	Object Function	Description	Group Address	Length	C	R	W	T	U	Data Type	Priority
148	Button 1 - Colour Temp.	Switch			1 bit	C	-	-	T	-	switch	Low
149	Button 1 - Colour Temp.	Brightness value			1 byte	C	-	-	T	-	percentage (0..100%)	Low
150	Button 1 - Colour Temp.	Colour temperature value			2 bytes	C	-	-	T	-	absolute colour temperature (K)	Low
153	Button 1 - Colour Temp.	Switch status			1 bit	C	-	W	T	U	switch	Low
154	Button 1 - Colour Temp.	Disable			1 bit	C	-	W	-	-	enable	Low
155	Button 1 - Colour Temp.	Status indication			1 byte	C	-	W	T	U	percentage (0..100%)	Low
Colour temperature switching/send value												
Number	Name	Object Function	Description	Group Address	Length	C	R	W	T	U	Data Type	Priority
148	Button 1 - Value sender	Short, 1bit value			1 bit	C	-	-	T	-	switch	Low
149	Button 1 - Value sender	Long, 1bit value			1 bit	C	-	-	T	-	switch	Low
148	Button 1 - Value sender	Short, 2bit value			2 bit	C	-	-	T	-	switch control	Low
149	Button 1 - Value sender	Long, 2bit value			2 bit	C	-	-	T	-	switch control	Low
148	Button 1 - Value sender	Short, 4bit value			4 bit	C	-	-	T	-	dimming control	Low
149	Button 1 - Value sender	Long, 4bit value			4 bit	C	-	-	T	-	dimming control	Low
154	Button 1 - Value sender	Disable			1 bit	C	-	W	-	-	enable	Low
155	Button 1 - Value sender	Status indication			1 byte	C	-	W	T	U	percentage (0..100%)	Low
Value sender												
Number	Name	Object Function	Description	Group Address	Length	C	R	W	T	U	Data Type	Priority
148	Button 1 - Scene	Scene			1 byte	C	-	-	T	-	scene control	Low
148	Button 1 - Scene	Short, Scene			1 byte	C	-	-	T	-	scene control	Low
149	Button 1 - Scene	Long, Scene			1 byte	C	-	-	T	-	scene control	Low
154	Button 1 - Scene	Disable			1 bit	C	-	W	-	-	enable	Low
155	Button 1 - Scene	Status indication			1 byte	C	-	W	T	U	percentage (0..100%)	Low
Scene control												
Number	Name	Object Function	Description	Group Address	Length	C	R	W	T	U	Data Type	Priority
148	Button 1 - Blind	Up/Down, Blind			1 bit	C	-	W	T	-	up/down	Low
149	Button 1 - Blind	Stop/Adjust, Blind			1 bit	C	-	W	T	-	step	Low
154	Button 1 - Blind	Disable			1 bit	C	-	W	-	-	enable	Low
155	Button 1 - Blind	Status indication			1 byte	C	-	W	T	U	percentage (0..100%)	Low
151	Button 1 - Blind	Flashing function			1 bit	C	-	W	-	U	enable	Low
Blind												
Number	Name	Object Function	Description	Group Address	Length	C	R	W	T	U	Data Type	Priority
148	Button 1 - Shift register	Register value			1 byte	C	-	W	T	U	counter pulses (0..255)	Low
154	Button 1 - Shift register	Disable			1 bit	C	-	W	-	-	enable	Low
155	Button 1 - Shift register	Status indication			1 byte	C	-	W	T	U	percentage (0..100%)	Low
Shift register												
Number	Name	Object Function	Description	Group Address	Length	C	R	W	T	U	Data Type	Priority
148	Button 1 - Multiple operation	Object1-On/Off			1 bit	C	-	W	T	-	switch	Low
149	Button 1 - Multiple operation	Object2-Up/Down			1 bit	C	-	W	T	-	up/down	Low
150	Button 1 - Multiple operation	Object3-SceneControl			1 byte	C	-	-	T	-	scene control	Low
151	Button 1 - Multiple operation	Object4-Percentage			1 byte	C	-	-	T	-	percentage (0..100%)	Low
154	Button 1 - Multiple operation	Disable			1 bit	C	-	W	-	-	enable	Low
155	Button 1 - Multiple operation	Status indication			1 byte	C	-	W	T	U	percentage (0..100%)	Low
148	Button 1 - Multiple operation	Object1-String			14 bytes	C	-	-	T	-	Character String (ISO 8859-1)	Low

Multiple operation



Number	Name	Object Function	Description	Group Address	Length	C	R	W	T	U	Data Type	Priority
148	Button 1 - Delay mode	Short, Delay mode			1 bit	C	-	-	T	-	switch	Low
149	Button 1 - Delay mode	Long, Delay mode			4 bit	C	-	-	T	-	dimming control	Low
154	Button 1 - Delay mode	Disable			1 bit	C	-	W	-	-	enable	Low
155	Button 1 - Delay mode	Status indication			1 byte	C	-	W	T	U	percentage (0..100%)	Low
<b>Delay mode</b>												
Number	Name	Object Function	Description	Group Address	Length	C	R	W	T	U	Data Type	Priority
148	Button 1 - RTC mode	Comfort mode			1 bit	C	-	-	T	-	enable	Low
149	Button 1 - RTC mode	Economy mode			1 bit	C	-	-	T	-	enable	Low
150	Button 1 - RTC mode	Frost/Heat protection mode			1 bit	C	-	-	T	-	enable	Low
151	Button 1 - RTC mode	Standby mode			1 bit	C	-	-	T	-	enable	Low
148	Button 1 - RTC mode	Operation mode			1 byte	C	-	-	T	-	HVAC mode	Low
154	Button 1 - RTC mode	Disable			1 bit	C	-	W	-	-	enable	Low
155	Button 1 - RTC mode	Status indication			1 byte	C	-	W	T	U	percentage (0..100%)	Low
<b>RTC operation mode</b>												
Number	Name	Object Function	Description	Group Address	Length	C	R	W	T	U	Data Type	Priority
148	Button 1 - String	String			14 bytes	C	-	-	T	-	Character String (ISO 8859-1)	Low
154	Button 1 - String	Disable			1 bit	C	-	W	-	-	enable	Low
<b>String(14bytes)</b>												
Number	Name	Object Function	Description	Group Address	Length	C	R	W	T	U	Data Type	Priority
148	Button 1 - Display	Status display(2byte temperature)			2 bytes	C	-	W	T	U	temperature (°C)	Low
148	Button 1 - Display	Status display(2byte humidity)			2 bytes	C	-	W	T	U	humidity (%)	Low
148	Button 1 - Display	Status display(1byte percentage)			1 byte	C	-	W	T	U	percentage (0..100%)	Low
148	Button 1 - Display	Status display(1byte unsigned)			1 byte	C	-	W	T	U	counter pulses (0..255)	Low
148	Button 1 - Display	Status display(2byte unsigned)			2 bytes	C	-	W	T	U	pulses	Low
148	Button 1 - Display	Status display(2byte lux)			2 bytes	C	-	W	T	U	lux (Lux)	Low
148	Button 1 - Display	Status display(2byte float)			2 bytes	C	-	W	T	U	2-byte float value	Low
148	Button 1 - Display	Status display(4byte unsigned)			4 bytes	C	-	W	T	U	counter pulses (unsigned)	Low
148	Button 1 - Display	Status display(4byte float)			4 bytes	C	-	W	T	U	4-byte float value	Low
148	Button 1 - Display	Status display(14byte)			14 bytes	C	-	W	-	-	Character String (ISO 8859-1)	Low
<b>Status display</b>												
Number	Name	Object Function	Description	Group Address	Length	C	R	W	T	U	Data Type	Priority
148	Rocker 1 - Setpoint	Current setpoint adjustment			2 bytes	C	-	-	T	-	temperature (°C)	Low
149	Rocker 1 - Setpoint	Current temperature setpoint			2 bytes	C	-	W	T	U	temperature (°C)	Low
148	Rocker 1 - Setpoint	Setpoint offset			1 bit	C	-	-	T	-	step	Low
148	Rocker 1 - Setpoint	Offset setpoint adjustment			2 bytes	C	-	-	T	-	temperature difference (K)	Low
149	Rocker 1 - Setpoint	Current Setpoint offset			2 bytes	C	-	W	T	U	temperature difference (K)	Low
154	Rocker 1 - Setpoint	Disable			1 bit	C	-	W	-	-	enable	Low
155	Rocker 1 - Setpoint	Status indication			2 bytes	C	-	W	T	U	temperature (°C)	Low
<b>Setpoint adjustment</b>												
Number	Name	Object Function	Description	Group Address	Length	C	R	W	T	U	Data Type	Priority
148	Button 1 - RGB	Switch			1 bit	C	-	-	T	-	switch	Low
149	Button 1 - RGB	RGB dimming value			3 bytes	C	-	-	T	-	RGB value 3x(0..255)	Low
151	Button 1 - RGB	RGB brightness, status			3 bytes	C	-	W	T	U	RGB value 3x(0..255)	Low
153	Button 1 - RGB	Switch status			1 bit	C	-	W	T	U	switch	Low
154	Button 1 - RGB	Disable			1 bit	C	-	W	-	-	enable	Low
155	Button 1 - RGB	Status indication			1 byte	C	-	W	T	U	percentage (0..100%)	Low
<b>RGB dimming</b>												
Number	Name	Object Function	Description	Group Address	Length	C	R	W	T	U	Data Type	Priority
148	Button 1 - RGBW	Switch			1 bit	C	-	-	T	-	switch	Low
149	Button 1 - RGBW	RGBW dimming value			6 bytes	C	-	-	T	-	RGBW value 4x(0..100%)	Low
151	Button 1 - RGBW	RGBW brightness, status			6 bytes	C	-	W	T	U	RGBW value 4x(0..100%)	Low
153	Button 1 - RGBW	Switch status			1 bit	C	-	W	T	U	switch	Low
154	Button 1 - RGBW	Disable			1 bit	C	-	W	-	-	enable	Low
155	Button 1 - RGBW	Status indication			1 byte	C	-	W	T	U	percentage (0..100%)	Low
149	Button 1 - RGBW	RGB dimming value			3 bytes	C	-	-	T	-	RGB value 3x(0..255)	Low
150	Button 1 - RGBW	White dimming value			1 byte	C	-	-	T	-	percentage (0..100%)	Low
151	Button 1 - RGBW	RGB brightness, status			3 bytes	C	-	W	T	U	RGB value 3x(0..255)	Low
152	Button 1 - RGBW	White brightness, status			1 byte	C	-	W	T	U	percentage (0..100%)	Low
<b>RGBW dimming</b>												

Number	Name	Object Function	Description	Group Address	Length	C	R	W	T	U	Data Type	Priority
148	Button 1 - Colour Temp.	Switch			1 bit	C	-	-	T	-	switch	Low
149	Button 1 - Colour Temp.	Brightness value			1 byte	C	-	-	T	-	percentage (0..100%)	Low
150	Button 1 - Colour Temp.	Absolute colour temperature			2 bytes	C	-	-	T	-	absolute colour temperature (K)	Low
151	Button 1 - Colour Temp.	Brightness value, status			1 byte	C	-	W	T	U	percentage (0..100%)	Low
152	Button 1 - Colour Temp.	Absolute colour temperature, sta...			2 bytes	C	-	W	T	U	absolute colour temperature (K)	Low
153	Button 1 - Colour Temp.	Switch status			1 bit	C	-	W	T	U	switch	Low
154	Button 1 - Colour Temp.	Disable			1 bit	C	-	W	-	-	enable	Low
155	Button 1 - Colour Temp.	Status indication			1 byte	C	-	W	T	U	percentage (0..100%)	Low
150	Button 1 - Colour Temp.	Percentage colour temperature			1 byte	C	-	-	T	-	percentage (0..100%)	Low
152	Button 1 - Colour Temp.	Percentage colour temperature, s...			1 byte	C	-	W	T	U	percentage (0..100%)	Low

Colour temperature dimming  
Fig.6.4 “Push button sensor” communication Object

NO.	Object Function	Name	Data Type	Flag	DPT
148	Switch	Button 1 - {{Switching}}	1bit	C,T	1.001 switch
148	Press/Short, Switch	Button 1 - {{Switching}}	1bit	C,T	1.001 switch
149	Release/Long, Switch	Button 1 - {{Switching}}	1bit	C,T	1.001 switch
153	Switch status	Button 1 - {{Switching}}	1bit	C,W,T,U	1.001 switch
152	Press/Short, switch status	Button 1 - {{Switching}}	1bit	C,W,T,U	1.001 switch
153	Release/Long, switch status	Button 1 - {{Switching}}	1bit	C,W,T,U	1.001 switch

These communication objects are used to trigger a switching operation. Use a common object or two separate objects is according to the parameter setting when press/release and long/short operation.

Only “Switch” and “Switch status” are visible when use a common object. If use two separate objects, “Press/Release” is visible when there is no distinction for short/long operation; “Short/Long” is visible when there is distinction for short/long operation. Telegrams:

0—Off  
1—On

Obj.148/Obj.149: used to send telegrams of switch control to the bus.

Obj.152/Obj.153: used to receive the feedback of switch status from the bus. If device restart, the object sends status request telegram (if sending parameter is enabled in General interface).

The name in parentheses changes with the parameter “Description (max 30char.)”. If description is empty, display “Button 1 - ....” by default. The same below.

148	Short, Switch	Button 1 - {{Dimming}}	1bit	C,T	1.001 switch
149	Long, Dimming	Button 1 - {{Dimming}}	4bit	C,W,T	3.007 dimming
153	Switch status	Button 1 - {{Dimming}}	1bit	C,W,T,U	1.001 switch

These communication objects are used to switch/dimming operation, with distinction for long/short operation.

Obj.148, Obj.153: as the same as above.

Obj.149: used to trigger a relative dimming operation.

Dimming down when telegram of object “Long, Dimming” is 1~7, and the larger this range the adjust step is smaller. That is, the maximum step of dimming down when is 1, and the minimum step of dimming down when is 7, stop dimming when is 0;

Dimming up when telegram is 9~15, and the larger this range the adjust step is smaller. That is, the maximum step of dimming up when is 9, and the minimum step of dimming up when is 15, stop dimming when is 8.

148	Up/Down, Blind	Button 1 - {{Blind}}	1bit	C,W,T	1.008 up/down
149	Stop/Adjust, Blind	Button 1 - {{Blind}}	1bit	C,W,T	1.007 step

These two communication objects are used to control the blind.

Obj.148: used to control blind up/down. Telegrams:

0——Move up

1——Move up

Obj.149: used to stop curtain movement. Telegram:

1——Stop

148	Short, 1bit value	Button 1 - {{Value send}}	1bit	C,T	1.001 switch
	Short, 2bit value		2bit		2.001 switch control
	Short, 4bit value		4bit		3.007 dimming
	Short, 1byte value		1byte		5.010 counter pulses
	Short, 2byte value		2byte		7.001 pulses
	Short, 2byte float value		2byte		9.x float value
	Short, 4byte value		4byte		12.001 counter pulses
	Short, 4byte float value		4byte		14.x float value
149	Long, 1bit value	Button 1 - {{Value send}}	1bit	C,T	1.001 switch
	Long, 2bit value		2bit		2.001 switch control
	Long, 4bit value		4bit		3.007 dimming
	Long, 1byte value		1byte		5.010 counter pulses
	Long, 2byte value		2byte		7.001 pulses
	Long, 2byte float value		2byte		9.x float value
	Long, 4byte value		4byte		12.001 counter pulses
	Long, 4byte float value		4byte		14.x float value

These communication objects are used to value sender. Object type and value range are determined by the parameter setting datatype.

Obj.148: used to send telegram to the bus when short operation.

Obj.149: used to send telegram to the bus when long operation.

148	Scene	Button 1 - {{Scene}}	1byte	C,T	18.001 scene control
148	Short, Scene	Button 1 - {{Scene}}	1byte	C,T	18.001 scene control
149	Long, Scene	Button 1 - {{Scene}}	1byte	C,T	18.001 scene control

These communication objects are used to scene control. Use a common object or two separate objects is according to the parameter setting when long/short operation.

Only the object “Scene” is visible when use a common object. If use two separate objects, “Short/Long” is visible when there is distinction for short/long operation. Telegrams:

Detailed 8bit the meaning of the directive.

Set up a 8bit Orders for the (Binary code): FXNNNNNN

F: '0' recall scene; '1' for storage scene;

X : 0 ;

NNNNNN: Scene number( 0... 63).

As follows:

Object message value	Description
0	Recall scene 1
1	Recall scene 2
2	Recall scene 3
...	...
63	Recall scene 64
128	Store scene 1
129	Store scene 2
130	Store scene 3
...	...
191	Store scene 64

Parameter setting Options are 1~64, actually communication object “Scene” corresponds to the telegram received is 0~63 . Such as parameter settings is the scene 1, communication object “Scene” sends the scene for 0.

149	Register value	Button 1 - {{Shifter}}	1byte	C,W,T,U	5.010 counter pulses 17.001 scene number 20.102 HVAC mode
-----	----------------	------------------------	-------	---------	---

This communication object is used to shift register. To send the value to the bus, object type is determined by the parameter setting datatype.

148	Switch	Button 1 - {{RGB}}	1bit	C,T	1.001 switch
149	RGB dimming value	Button 1 - {{RGB}}	3byte	C,T	232.600 RGB value 3x(0..255)
151	RGB brightness, status	Button 1 - {{RGB}}	3byte	C,W,T,U	232.600 RGB value 3x(0..255)



<b>153</b>	<b>Switch status</b>	<b>Button 1 - {{RGB}}</b>	<b>1bit</b>	<b>C,W,T,U</b>	<b>1.001 switch</b>																		
<p>These communication objects are used for RGB switching/send value and dimming, and RGBW dimming. Obj.148, Obj.153: as the same as above.</p> <p>When RGB object type is selected 1x3byte or RGBW is selected 3byte+1byte, Obj.149 and Obj.151 are visible:</p> <p>Obj.149: used to send brightness value of RGB three-colour lamp to the bus.</p> <p>Obj.151: only visible when dimming function, used to receive brightness telegram of RGB three-colour lamp from bus.</p> <p>3-Byte Code for RGB Dimming Object Data Type: U8 U8 U8, as follows:</p> <table border="1" style="margin-left: auto; margin-right: auto;"> <tr> <td style="text-align: center;">3<sub>MSB</sub></td> <td style="text-align: center;">2</td> <td style="text-align: center;">1<sub>LSB</sub></td> </tr> <tr> <td style="text-align: center;">R</td> <td style="text-align: center;">G</td> <td style="text-align: center;">B</td> </tr> <tr> <td style="text-align: center;">UUUUUUU</td> <td style="text-align: center;">UUUUUUU U</td> <td style="text-align: center;">UUUUUUU</td> </tr> </table> <p>R: red dimming value; G: green dimming value; B: blue dimming value.</p>						3 <sub>MSB</sub>	2	1 <sub>LSB</sub>	R	G	B	UUUUUUU	UUUUUUU U	UUUUUUU									
3 <sub>MSB</sub>	2	1 <sub>LSB</sub>																					
R	G	B																					
UUUUUUU	UUUUUUU U	UUUUUUU																					
<b>148</b>	<b>Switch</b>	<b>Button 1 - {{RGBW}}</b>	<b>1bit</b>	<b>C,T</b>	<b>1.001 switch</b>																		
<b>149</b>	<b>RGBW dimming value</b>	<b>Button 1 - {{RGBW}}</b>	<b>6byte</b>	<b>C,T</b>	<b>251.600 DPT_Colour_RGBW</b>																		
<b>151</b>	<b>RGBW brightness, status</b>	<b>Button 1 - {{RGBW}}</b>	<b>6byte</b>	<b>C,W,T,U</b>	<b>251.600 DPT_Colour_RGBW</b>																		
<b>153</b>	<b>Switch status</b>	<b>Button 1 - {{RGBW}}</b>	<b>1bit</b>	<b>C,W,T,U</b>	<b>1.001 switch</b>																		
<p>These communication objects are used for RGBW switching/send value and dimming. Obj.148, Obj.153: as the same as above.</p> <p>When RGBW object type is selected 1x6byte, Obj.149 and Obj.151 are visible:</p> <p>Obj.149: used to send brightness value of RGBW four-colour lamp to the bus.</p> <p>Obj.151: only visible when dimming function, used to receive brightness telegram of RGBW four-colour lamp from bus.</p> <p>Encoding of the data type of the 6-byte RGBW dimming object: U8 U8 U8 U8 R8 R4 B4, as follows:</p> <table border="1" style="margin-left: auto; margin-right: auto;"> <tr> <td style="text-align: center;">6<sub>MSB</sub></td> <td style="text-align: center;">5</td> <td style="text-align: center;">4</td> <td style="text-align: center;">3</td> <td style="text-align: center;">2</td> <td style="text-align: center;">1<sub>LSB</sub></td> </tr> <tr> <td style="text-align: center;">R</td> <td style="text-align: center;">G</td> <td style="text-align: center;">B</td> <td style="text-align: center;">W</td> <td style="text-align: center;">Reserve</td> <td style="text-align: center;">r r r r mR mG mB mW</td> </tr> <tr> <td style="text-align: center;">UUUUUUUU</td> <td style="text-align: center;">UUUUUUUU</td> <td style="text-align: center;">UUUUUUUU</td> <td style="text-align: center;">UUUUUUUU</td> <td style="text-align: center;">00000000</td> <td style="text-align: center;">0000BBBB</td> </tr> </table>						6 <sub>MSB</sub>	5	4	3	2	1 <sub>LSB</sub>	R	G	B	W	Reserve	r r r r mR mG mB mW	UUUUUUUU	UUUUUUUU	UUUUUUUU	UUUUUUUU	00000000	0000BBBB
6 <sub>MSB</sub>	5	4	3	2	1 <sub>LSB</sub>																		
R	G	B	W	Reserve	r r r r mR mG mB mW																		
UUUUUUUU	UUUUUUUU	UUUUUUUU	UUUUUUUU	00000000	0000BBBB																		

R: red dimming value; G: green dimming value; B: blue dimming value; W: white dimming value;

mR: determines whether the red dimming value is valid, 0 = invalid, 1 = valid;

mG: determines whether the green dimming value is valid, 0 = invalid, 1 = valid;

mB: determines whether the blue dimming value is valid, 0 = invalid, 1 = valid;

mW: Determines whether the white dimming value is valid, 0 = invalid, 1 = valid.

149	Red dimming value	Button 1 - {{RGBW}}	1byte	C,T	5.001 percentage(0..100%)
150	Green dimming value	Button 1 - {{RGBW}}	1byte	C,T	5.001 percentage(0..100%)
151	Blue dimming value	Button 1 - {{RGBW}}	1byte	C,T	5.001 percentage(0..100%)
152	White dimming value	Button 1 - {{RGBW}}	1byte	C,T	5.001 percentage(0..100%)
<p>These communication objects are used for RGB and RGBW switching/send value.                      Obj.149~Obj.151 are visible when 3x1byte for the RGB object type or 4x1byte for the RGBW object type,                      Obj.152 is only visible when RGBW is selected 4x1byte. Telegrams: 0...100%</p> <p>Obj.149: used to send brightness value of the control R (red) channel to the bus.                      Obj.150: used to send brightness value of the control G (green) channel to the bus.                      Obj.151: used to send brightness value of the control B (blue) channel to the bus.                      Obj.152: used to send brightness value of the control W (white) channel to the bus.</p>					
150	White dimming value	Button 1 - {{RGBW}}	1byte	C,T	5.001 percentage(0..100%)
152	White brightness, status	Button 1 - {{RGBW}}	1byte	C,W,T,U	5.001 percentage(0..100%)
<p>These communication objects are used for RGBW dimming, and visible when object type is 3byte+1byte.                      Telegrams: 0...100%</p> <p>Obj.150: used to send brightness value of the control W (white) channel to the bus.                      Obj.152: used to receive brightness telegram of the control W (white) channel from bus.</p>					
148	Switch	Button 1 -{{Colour Temp.}}	1bit	C,T	1.001 switch
149	Brightness value	Button 1 -{{Colour Temp.}}	1byte	C,T	5.001 percentage(0..100%)
150	Colour temperature value	Button 1 -{{Colour Temp.}}	2byte	C,T	5.001 percentage(0..100%)
	Percentage colour temperature				7.600 absolute colour
	Absolute colour temperature				temperature
151	Brightness value, status	Button 1 -{{Colour Temp.}}	1byte	C,W,T,U	5.001 percentage(0..100%)

152	Percentage colour temperature, status Absolute colour temperature, status	Button 1 -{{Colour Temp.}}	1byte 2byte	C,W,T,U	5.001 percentage(0..100%) 7.600 absolute colour temperature
153	Switch status	Button 1 -{{Colour Temp.}}	1bit	C,W,T,U	1.001 switch
<p>These communication objects are used for colour temperature switching/send value and dimming.</p> <p>Obj.148, Obj.153: as the same as above.</p> <p>Obj.149: used to send the dimming telegram of the colour temperature to the bus, that is, sending the brightness value. Telegrams: 0...100%</p> <p>Obj.150: only display “Colour temperature value” when switching/send value; display “Percentage colour temperature” or “Absolute colour temperature” according to object type when dimming function. Used to send the control telegram of the colour temperature to the bus.</p> <p>Telegrams: 1byte is 0..100% and 2byte is 2000...7000 K</p> <p>Obj.151: only visible when dimming function, used to receive status of brightness value from bus.</p> <p>Obj.152: only visible when dimming function, display “Percentage colour temperature” or “Absolute colour temperature” according to object type. Used to receive colour temperature status from bus.</p>					
148	Object1-On/Off Object1-Up/Down Object1-SceneControl Object1-Percentage Object1-Unsigned value Object1-String	Button 1 - {{Multiple operation}}	1bit 1bit 1byte 1byte 1byte 14byte	C,W,T C,W,T C,T C,T C,T C,T	1.001 switch 1.008 up/down 18.001 scene control 5.001 percentage(0..100%) 5.010 counter pulses 16.001 character string (ISO 8859-1)
<p>These communication objects are used to multiple operation, up to activate 4 objects at the same time, and operation once can send the value of 4 different datatype objects to the bus via these objects. Range of values that can be sent are determined by the datatype, and the datatype is determined by the parameter setting.</p> <p><b>Note: 14byte is only applied to object1.</b></p>					
148	Short, Delay mode	Button 1 - {{Delay mode}}	1bit 4bit 1byte	C,T	1.001 switch 3.007 dimming 5.010 counter pulses
149	Long, Delay mode	Button 1 - {{Delay mode}}	1bit 4bit 1byte	C,T	1.001 switch 3.007 dimming 5.010 counter pulses
<p>These communication objects are used to delay mode. Range of values that can be sent are determined by the datatype, and the datatype is determined by the parameter setting.</p> <p>Obj.148: used to send telegrams of delay mode to the bus when short operation.</p> <p>Obj.149: used to send telegrams of delay mode to the bus when long operation.</p>					

148	Operation mode	Button 1 - {{RTC mode}}	1byte	C,T	20.102 HVAC mode
148	Comfort mode	Button 1 - {{RTC mode}}	1bit	C,T	1.003 enable
149	Economy mode	Button 1 - {{RTC mode}}	1bit	C,T	1.003 enable
150	Frost/Heat protection mode	Button 1 - {{RTC mode}}	1bit	C,T	1.003 enable
151	Standby mode	Button 1 - {{RTC mode}}	1bit	C,T	1.003 enable
<p>These communication objects are used to RTC operation. Used to send the operation mode of RTC to the bus.</p> <p>When 1 byte: object 148 is visible, telegrams: 1-Comfort, 2-Standby, 3-Economy, 4-Protection, other reserved.</p> <p>When 1bit:</p> <p>Object 148——Comfort mode</p> <p>Object 149——Economy mode</p> <p>Object 150——Protection mode</p> <p>Object 151——Standby mode</p> <p>Only corresponding object send telegram “1” when activate one mode. When 1 bit standby object is not enable, three objects comfort, economy, protection all send 0 to activate standby mode. When 1 bit standby object is enable, only standby object sends 1 to activate standby mode.</p>					
148	String	Button 1 - {{String}}	14byte	C,T	16.001 character string (ISO 8859-1)
<p>This communication object is used to string function. Used to send the sting to the bus.</p>					
148	Status display(...)	Button 1 - {{Display}}	1byte 2byte 4byte	C,W,T,U	5.001 percentage(0..100%) 5.010 counter pulses 7.001 pulses 9.001 temperature 9.007 humidity 9.004 lux(lux) 9.x float value 12.001 counter pulses 14.x float value
148	Status display(...)	Button 1 - {{Display}}	14byte	C,W	16.001 character string (ISO 8859-1)

<p>This communication object is used to status display. Used to receive the data of status display, and get the corresponding value from the bus to be updated to the display. Range of values determined by the datatype, and the datatype is determined by the parameter setting.</p>					
148	Current setpoint adjustment	Rocker 1 - {{Setpoint}}	2byte	C,T	9.001 temperature
149	Current temperature setpoint	Rocker 1 - {{Setpoint}}	2byte	C,W,T,U	9.001 temperature
<p>These communication objects are used to setpoint temperature adjustment, are visible when “Setpoint adjustment(absolute)” is selected.</p> <p>Obj.148: used to send current setpoint temperature to the bus when button operation.</p> <p>Obj.149: used to receive the current setpoint temperature. If device restart, the object sends status request telegram (if sending parameter is enabled in General interface).</p>					
148	Setpoint offset	Rocker 1 - {{Setpoint}}	1bit	C,T	1.007 step
<p>This communication object is used to setpoint temperature adjustment, are visible when “Offset Increase/Decrease(relative)” is selected.</p> <p>Used to send the telegrams of setpoint temperature increase/decrease to the bus when button operation.</p> <p>Telegrams:</p> <p style="padding-left: 40px;">0——Decrease</p> <p style="padding-left: 40px;">1——Increase</p>					
148	Offset setpoint adjustment	Rocker 1 - {{Setpoint}}	2byte	C,T	9.001 temperature
149	Current Setpoint offset	Rocker 1 - {{Setpoint}}	2byte	C,W,T,U	9.001 temperature
<p>These communication objects are used to setpoint temperature adjustment, are visible when “Offset setpoint adjustment(relative)” is selected.</p> <p>Obj.148: used to send the offset of the current setpoint adjustment to the bus when button operation.</p> <p>Obj.149: used to receive the offset of the current setpoint adjustment from bus.If device restart, the object sends status request telegram (if sending parameter is enabled in General interface).</p>					
151	Flashing function	Button 1 - {...}	1bit	C,W,U	1.003 enable
<p>This communication object is only applied to switch, dimming and blind. Used to disable/enable flashing function.</p>					

<b>154</b>	<b>Disable</b>	<b>Button 1 - {...}</b>	<b>1bit</b>	<b>C,T</b>	<b>1.003 enable</b>
<p>This communication object is used to the above functions expect for status display function. Used to disable/enable the function of contact input.</p>					
<b>155</b>	<b>Status indication</b>	<b>Button 1 - {...}</b>	<b>1bit 1byte</b>	<b>C,W,T,U</b>	<b>1.001 switch 5.010 counter pulses 5.001 percentage(0..100%)</b>
<b>155</b>	<b>Status indication</b>	<b>Rocker 1 - {...}</b>	<b>1bit 1byte</b>	<b>C,W,T,U</b>	<b>1.001 switch 5.010 counter pulses 5.001 percentage(0..100%) 7.600 absolute colour temperature 9.001 temperature(° C)</b>
<p>This communication object is used to control the status of button function on the screen via the bus, and also can receive status feedback. Range of telegram values is determined by the datatype, and the datatype is determined by the parameter setting.</p> <p>If device restart, the object sends status request telegram (if sending parameter is enabled in General interface).</p>					

Table 6.4 “Push button sensor” communication object table

## 6.5. “Multifunction thermostat” Communication Object

### 6.5.1. “FCU” Communication Object

When the work mode is “Master”, the read requests of external sensor (with separate enable parameter, the same below), fan speed, the window and the presence are sent to the bus after voltage recovery, as well as send the status of power on/off, actual temperature (combined), current setpoint temperature, heating/cooling mode, operation mode, fan speed and fan automatic.

When the work mode is “Single”, the read requests of external sensor, fan speed, the window and the presence are sent to the bus after voltage recovery, as well as the status of actual temperature (combined).

When the work mode is “Slave”, send the status requests of these functions after voltage recovery: power on/off, the external sensor, current setpoint temperature, heating/cooling control mode, operation mode, fan speed and fan automatic.

Number	Name	Object Function	Description	Group Address	Length	C	R	W	T	U	Data Type	Priority
250	FCU	Locking function			1 bit	C	-	W	-	-	enable	Low
251	FCU	Power on/off, status			1 bit	C	-	W	T	U	switch	Low
252	FCU	External temperature sensor			2 bytes	C	-	W	T	U	temperature (°C)	Low
253	FCU	Base temperature setpoint, status			2 bytes	C	-	W	-	U	temperature (°C)	Low
254	FCU	Heating/Cooling mode, status			1 bit	C	-	W	-	U	cooling/heating	Low
255	FCU	Operation mode, status			1 byte	C	-	W	-	U	HVAC mode	Low
256	FCU	Comfort mode, status			1 bit	C	-	W	-	U	enable	Low
257	FCU	Standby mode, status			1 bit	C	-	W	-	U	enable	Low
258	FCU	Economy mode, status			1 bit	C	-	W	-	U	enable	Low
259	FCU	Frost/Heat protection mode, status			1 bit	C	-	W	-	U	enable	Low
260	FCU	Fan speed, status			1 byte	C	-	W	T	U	percentage (0..100%)	Low
261	FCU	Fan Automatic operation, status			1 bit	C	-	W	-	U	enable	Low
263	FCU	Window contact			1 bit	C	-	W	T	U	window/door	Low
264	FCU	Presence detector			1 bit	C	-	W	T	U	occupancy	Low
266	FCU	Scene			1 byte	C	-	W	-	-	scene control	Low
267	FCU	Power on/off			1 bit	C	R	-	T	-	switch	Low
268	FCU	Actual temperature			2 bytes	C	R	-	T	-	temperature (°C)	Low
269	FCU	Current base setpoint temperature			2 bytes	C	-	-	T	-	temperature (°C)	Low
270	FCU	Current setpoint adjustment			2 bytes	C	R	-	T	-	temperature (°C)	Low
271	FCU	Heating/Cooling mode			1 bit	C	R	-	T	-	cooling/heating	Low
272	FCU	Operation mode			1 byte	C	R	-	T	-	HVAC mode	Low
273	FCU	Comfort mode			1 bit	C	-	-	T	-	enable	Low
274	FCU	Standby mode			1 bit	C	-	-	T	-	enable	Low
275	FCU	Economy mode			1 bit	C	-	-	T	-	enable	Low
276	FCU	Frost/Heat protection mode			1 bit	C	-	-	T	-	enable	Low
277	FCU	Heating/cooling control value			1 byte	C	R	-	T	-	percentage (0..100%)	Low
279	FCU	Fan speed			1 byte	C	R	-	T	-	percentage (0..100%)	Low
280	FCU	Fan Automatic operation			1 bit	C	R	-	T	-	enable	Low

Fig.6.5.1 “FCU” communication Object

NO.	Object Function	Name	Data Type	Flag	DPT
250	Locking function	FCU	1bit	C,W	1.003 enable
The communication object is used to lock/unlock FCU control function. Telegrams: 0——Lock 1——Unlock					

251	Power on/off	FCU	1bit	C,W	1.001 switch
251	Power on/off, status	FCU	1bit	C,W,T,U	1.001 switch
<p>When the work mode is “Master” or “Single”, the flag is C,W, “Power on/off” is visible, used to receive telegram from bus to control power on/off.</p> <p>When the work mode is “Slave”, the flag is C,W,T,U, “Power on/off, status” is visible, used to receive the status of power on/off, which is fed back from the controller on the bus.</p> <p>Telegrams:</p> <p style="padding-left: 40px;">1——On</p> <p style="padding-left: 40px;">0——Off</p>					
252	External temperature sensor	FCU	2byte	C,W,T,U	9.001 temperature
<p>The communication object is used to receive the room temperature from the bus, and send read request cyclically, and feedback to screen display.</p>					
253	Current temperature setpoint Base temperature setpoint	FCU	2byte	C,W,U	9.001 temperature
253	Current temperature setpoint, status	FCU	2byte	C,W,T,U	9.001 temperature
<p>When the work mode is “Master”, the flag is C,W,U:</p> <p>“Current temperature setpoint” is visible when operation mode is not enabled, and under absolute adjustment. Used to modify the base value of the set temperature; and to modify set temperature value of current room operation mode when absolute adjustment.</p> <p>“Base temperature setpoint” is visible only when relative adjustment, used to modify the base value of the set temperature, that is, the temperature setting value of the comfort mode, and the setpoint temperature of the standby mode and the economy mode changes according to the relative change. In the protection mode, only the temperature setting value of the protection mode is modified.</p> <p>When the work mode is “Slave”, the flag is C,W,T,U, only “Current temperature setpoint, status” is visible, used to receive the status of current setpoint temperature, which is fed back from the controller on the bus.</p> <p>While “Single”, no these objects.</p>					
254	Heating/Cooling mode	FCU	1bit	C,W,U	1.100 cooling/heating
254	Heating/Cooling mode, status	FCU	1bit	C,W,T,U	1.100 cooling/heating
<p>When the work mode is “Master” or “Single”, the flag is C,W,U, “Heating/Cooling mode” is visible, used to receive telegram from bus to control heating/cooling mode.</p> <p>When the work mode is “Slave”, the flag is C,W,T,U, “Heating/Cooling mode, status” is visible, used to receive the status of heating/cooling mode, which is fed back from the controller on the bus.</p>					



Telegrams: 1——Heating 0——Cooling					
255	Operation mode	FCU	1byte	C,W,U	20.102 HVAC mode
255	Operation mode, status	FCU	1byte	C,W,T,U	20.102 HVAC mode
256	Comfort mode	FCU	1bit	C,W,U	1.003 enable
257	Standby mode	FCU	1bit	C,W,U	1.003 enable
258	Economy mode	FCU	1bit	C,W,U	1.003 enable
259	Frost/Heat protection mode	FCU	1bit	C,W,U	1.003 enable
When 1byte, Object255 is visible: When the work mode is “Master” or “Single”, the flag is C,W,U, “Operation mode” is visible, used to receive telegram from bus to control operation mode. When the work mode is “Slave”, the flag is C,W,T,U, “Operation mode, status” is visible, used to receive the status of operation mode., which is fed back from the controller on the bus. Telegram value: 1-Comfort, 2-Standby, 3-Economy, 4-Protection, other reserved.					
When 1bit, used to receive telegrams from bus to control each operation mode: Object256——Comfort mode Object227——Standby mode Object258——Economy mode Object259——Protection mode When the object receives the telegram “1”, the corresponding mode is activated and the display status of the mode on the screen will also be updated to the corresponding mode. When 1 bit standby object is not enable, three objects comfort, economy, protection all send 0 to activate standby mode. When 1 bit standby object is enable, only standby object sends 1 to activate standby mode, 0 is ignored. When the work mode is “Single” or “Slave”, these four 1bit objects are not visible.					
260	Fan speed, status	FCU	1byte	C,W,T,U	5.001 percentage 5.100 fan stage
The communication object is used to receive the current fan speed from the bus. Telegram value is determined by parameter setting datatype.					
261	Fan automatic operation, status	FCU	1bit	C,W,T,U	1.003 enable
The communication object is used to receive feedback status of fan automatic fan operation from the bus. Telegrams:					

		1— Automatic				
		0— Cancel automatic				
<b>262</b>	<b>Extended comfort mode</b>	<b>FCU</b>	<b>1bit</b>	<b>C,W</b>	<b>1.016 acknowledge</b>	
<p>The communication object is used for triggering time to extended comfort mode. Telegrams:</p> <p>1— Activate comfort mode</p> <p>0— No available</p> <p>Activate comfort mode when the object receives telegram 1. If receive again telegram 1 in delay time, time will be timed again. And return the previous operation mode from comfort mode once finish timing. If there is a new operation mode in delay time, exit the comfort mode.</p> <p>Change the operation mode will exit the timing, but switch the heating/cooling will not.</p> <p>When the work mode is “Slave”, this object is not visible.</p>						
<b>263</b>	<b>Window contact</b>	<b>FCU</b>	<b>1bit</b>	<b>C,W,T,U</b>	<b>1.019 Window/door</b>	
<p>The communication object is used to receive the switch status of window contact. Telegrams:</p> <p>1— Open window</p> <p>0— Close window</p> <p>When the work mode is “Slave”, this object is not visible.</p>						
<b>264</b>	<b>Presence detector</b>	<b>FCU</b>	<b>1bit</b>	<b>C,W,T,U</b>	<b>1.018 occupancy</b>	
<p>The communication object is used to receive the room occupancy status from presence detector. Telegrams:</p> <p>1— Occupied</p> <p>0— Not occupied</p> <p>When the work mode is “Slave”, this object is not visible.</p>						
<b>266</b>	<b>Scene</b>	<b>FCU</b>	<b>1byte</b>	<b>C,W</b>	<b>18.001 scene control</b>	
<p>The communication object is visible when scene function enabled. Used to recall/storage scene via bus.</p> <p>When the work mode is “Slave”, this object is not visible.</p>						
<b>267</b>	<b>Power on/off, status</b>	<b>FCU</b>	<b>1bit</b>	<b>C,R,T</b>	<b>1.001 switch</b>	
<b>267</b>	<b>Power on/off</b>	<b>FCU</b>	<b>1bit</b>	<b>C,T</b>	<b>1.001 switch</b>	
<p>When the work mode is “Master” or “Single”, the flag is C,R,T, “Power on/off, status” is visible, used to feed back status of power on/off to the bus.</p> <p>When the work mode is “Slave”, the flag is C,T, “Power on/off” is visible, used to send the power on/off telegram to bus, to control the controller on the KNX bus.</p>						
<b>268</b>	<b>Actual temperature</b>	<b>FCU</b>	<b>2byte</b>	<b>C,R,T</b>	<b>9.001 temperature</b>	

<p>The communication object is used for transmitting the actual temperature value detected by the combination temperature sensor of the device to the bus.</p>					
269	Current base setpoint temperature, status	FCU	2byte	C,R,T	9.001 temperature
<p>When the work mode is “Master”, the communication object is visible when relative adjustment is selected. Used to send the current base setpoint temperature value to the bus.</p> <p>When the work mode is “Slave” or “Single”, this object is not visible.</p>					
270	Current setpoint adjustment, status	FCU	2byte	C,R,T	9.001 temperature
270	Current setpoint adjustment	FCU	2byte	C,T	9.001 temperature
<p>When the work mode is “Master”, the flag is C,R,T, “Current setpoint adjustment, status” is visible, used to feed back status of current setpoint temperature to the bus.</p> <p>When the work mode is “Slave”, the flag is C,T, “Current setpoint adjustment” is visible, used to send the current setpoint temperature to bus.</p> <p>While “Single”, this object is not visible.</p>					
271	Heating/Cooling mode, status	FCU	1bit	C,R,T	1.100 cooling/heating
<p>When the work mode is “Master” or “Single”, the communication object is visible when control mode is “Heating and Cooling” and “Only via object” is not selected. Used to send telegrams from switching cooling and heating functions to the bus. Telegram value:</p> <p style="padding-left: 40px;">1 — Heating</p> <p style="padding-left: 40px;">0 — Cooling</p> <p>While “Slave”, this object is not visible.</p>					
272	Operation mode, status	FCU	1byte	C,R,T	20.102 HVAC mode
272	Operation mode	FCU	1byte	C,T	20.102 HVAC mode
273	Comfort mode, status	FCU	1bit	C,T	1.003 enable
274	Standby mode, status	FCU	1bit	C,T	1.003 enable
275	Economy mode, status	FCU	1bit	C,T	1.003 enable
276	Frost/Heat protection mode, status	FCU	1bit	C,T	1.003 enable
<p>When 1byte, Object272 is visible:</p> <p>When the work mode is “Master” or “Single”, the flag is C,R,T, “Operation mode, status” is visible, used to feed back status of operation mode to the bus.</p>					

<p>When the work mode is “Slave”, the flag is C,T, “Operation mode” is visible, used to send the operation mode of controller to bus.</p> <p>Telegrams: 1: Comfort mode; 2: Standby mode; 3: Economy mode; 4: Protection mode; other reserved.</p> <p>When 1bit:</p> <p>Switch to the corresponding mode, and the object of the corresponding mode sends the telegram “1” to the bus.</p> <p>When the work mode is “Single” or “Slave”, these four 1bit objects are not visible.</p>					
277	Heating/cooling control value	FCU	1bit	C,R,T	1.001 Switch
	Heating control value		1byte		5.001 percentage
278	Cooling control value	FCU	1bit 1byte	C,R,T	1.001 Switch 5.001 percentage
<p>These communication objects are used to send control value of heating or cooling function to the bus. Object is depending on the control mode and control system (2-pipe or 4 pipe) to display, and object datatype is according to parameter setting.</p> <p>When the work mode is “Slave”, these two objects are not visible.</p>					
279	Fan speed	FCU	1byte	C,T	5.001 percentage
				C,R,T	5.100 fan stage
<p>The communication object is used to send control telegrams of the fan speed to the bus. The corresponding telegram value of each fan speed is defined by the parameter. Activate the corresponding fan speed on the panel, and send the corresponding telegram value of the fan speed to the bus.</p> <p>When the work mode is “Master”, the flag is C,R,T; when “Slave” or “Single”, the flag is C,T.</p>					
280	Fan automatic operation	FCU	1bit	C,T C,R,T	1.003 enable
<p>The communication object is used to activate the fan automatic operation via the bus. Telegrams:</p> <p>1——Automatic</p> <p>0——Cancel automatic</p> <p>When the work mode is “Master”, the flag is C,R,T; when “Slave” or “Single”, the flag is C,T.</p>					

Table 6.5.1 “FCU” communication object table

### 6.5.2. “VRF” Communication Object

System needs to return to the status as before voltage failure when voltage recovery, as well as send these status requests: power on/off, mode, fan speed, setpoint temperature, external temperature sensor and vanes swing.

Number	Name	Object Function	Description	Group Address	Length	C	R	W	T	U	Data Type	Priority
281	VRF	Locking function			1 bit	C	-	W	-	-	enable	Low
282	VRF	Power on/off, status			1 bit	C	-	W	T	U	switch	Low
283	VRF	External temperature sensor			2 bytes	C	-	W	T	U	temperature (°C)	Low
284	VRF	Current temperature setpoint, sta...			2 bytes	C	-	W	T	U	temperature (°C)	Low
285	VRF	Control mode, status			1 byte	C	-	W	T	U	HVAC control mode	Low
286	VRF	Fan speed, status			1 byte	C	-	W	T	U	percentage (0..100%)	Low
287	VRF	Vanes swing (1-swing,0-stop), stat...			1 bit	C	-	W	T	U	start/stop	Low
289	VRF	Scene			1 byte	C	-	W	-	-	scene control	Low
290	VRF	Power on/off			1 bit	C	-	-	T	-	switch	Low
291	VRF	Current setpoint adjustment			2 bytes	C	-	-	T	-	temperature (°C)	Low
292	VRF	Fan speed			1 byte	C	-	-	T	-	percentage (0..100%)	Low
293	VRF	Vanes swing (1-swing,0-stop)			1 bit	C	-	-	T	-	start/stop	Low
294	VRF	Control mode			1 byte	C	-	-	T	-	HVAC control mode	Low

Fig.6.5.2 “VRF” communication Object

NO.	Object Function	Name	Data Type	Flag	DPT
281	Locking function	VRF	1bit	C,W	1.003 enable
<p>The communication object is used to lock/unlock VRF control function. Telegrams:</p> <p>0——Lock</p> <p>1——Unlock</p>					
282	Power on/off, status	VRF	1bit	C,W,T,U	1.001 switch
<p>The communication object is used to receive the power on/off telegram of VRF from the bus. Telegrams:</p> <p>1——On</p> <p>0——Off</p>					
283	External temperature sensor	VRF	2byte	C,W,T,U	9.001 temperature
<p>The communication object is used to receive the room temperature from the bus, and send read request cyclically, and feedback to screen display.</p>					
284	Current temperature setpoint, status	VRF	1byte 2byte	C,W,T,U	5.010 counter pulses 9.001 temperature
<p>The communication object is used to receive the current setpoint temperature value from the bus.</p>					
285	Control mode, status	VRF	1byte	C,W,T,U	20.105 HVAC control mode
<p>The communication object is used to receive the current control mode from the bus. Different telegram means different control mode: 0-Auto, 1- Heating, 3-Cooling, 9-Fan, 14-Dehumidity, other reserved.</p>					
286	Fan speed, status	VRF	1byte	C,W,T,U	5.001 percentage 5.100 fan stage

The communication object is used to receive the current fan speed from the bus. Telegram value is determined by parameter setting datatype.					
<b>287</b>	<b>Vanes swing (1-swing,0-stop), status</b>	<b>VRF</b>	<b>1bit</b>	<b>C,W,T,U</b>	<b>1.010 start/stop</b>
The communication object is visible when swing function enabled. Used to receive vanes swing status from the bus. Telegrams: 1—Swing 0—Stop					
<b>289</b>	<b>Scene</b>	<b>VRF</b>	<b>1byte</b>	<b>C,W</b>	<b>18.001 scene control</b>
The communication object is visible when scene function enabled. Used to recall/storage scene via bus.					
<b>290</b>	<b>Power on/off</b>	<b>VRF</b>	<b>1bit</b>	<b>C,T</b>	<b>1.001 switch</b>
The communication object is used to send the power on/off telegram of VRF, to control VRF power on/off on the KNX bus.					
<b>291</b>	<b>Current setpoint adjustment</b>	<b>VRF</b>	<b>1byte</b>	<b>C,T</b>	<b>5.001 percentage</b> <b>5.100 fan stage</b>
The communication object is used to adjust setpoint temperature via the bus, and send telegram value to the bus.					
<b>292</b>	<b>Fan speed</b>	<b>VRF</b>	<b>1byte</b>	<b>C,T</b>	<b>5.001 percentage</b> <b>5.100 fan stage</b>
The communication object is used to send control telegram of each fan speed to the bus. Telegram value is determined by parameter setting datatype.					
<b>293</b>	<b>Vanes swing (1-swing,0-stop)</b>	<b>VRF</b>	<b>1bit</b>	<b>C,T</b>	<b>1.010 start/stop</b>
The communication object is visible when swing function enabled. Used to send telegram controlling vanes swing to the bus. Telegrams: 1—Swing 0—Stop					
<b>294</b>	<b>Control mode</b>	<b>VRF</b>	<b>1byte</b>	<b>C,T</b>	<b>20.105 HVAC control mode</b>
The communication object is used to send control telegram of each air condition mode to the bus. Different telegram means different control mode: 0-Auto, 1- Heating, 3-Cooling, 9-Fan, 14-Dehumidity, other reserved.					

Table 6.5.2 “VRF” communication object table

### 6.5.3. “Floor heating” Communication Object

When the work mode is “Master”, the read requests of external sensor is sent to the bus after voltage recovery, as well as send the status of power on/off, actual temperature (combined), current setpoint temperature.

When the work mode is “Single”, the read requests of external sensor is sent to the bus after voltage recovery, as well as send the status of the actual temperature (combined).

When the work mode is “Slave”, send the status requests of these functions after voltage recovery: power on/off, the external sensor, current setpoint temperature.

Number	Name	Object Function	Description	Group Address	Length	C	R	W	T	U	Data Type	Priority
295	Floor heating	Locking function			1 bit	C	-	W	-	-	enable	Low
296	Floor heating	Power on/off, status			1 bit	C	-	W	T	U	switch	Low
297	Floor heating	External temperature sensor			2 bytes	C	-	W	T	U	temperature (°C)	Low
298	Floor heating	Current temperature setpoint, status			2 bytes	C	-	W	-	U	temperature (°C)	Low
300	Floor heating	Scene			1 byte	C	-	W	-	-	scene control	Low
301	Floor heating	Power on/off			1 bit	C	R	-	T	-	switch	Low
302	Floor heating	Actual temperature			2 bytes	C	R	-	T	-	temperature (°C)	Low
303	Floor heating	Current setpoint adjustment			2 bytes	C	R	-	T	-	temperature (°C)	Low
304	Floor heating	Heating on/off			1 bit	C	-	-	T	-	switch	Low

Fig.6.5.3 “Floor heating” communication Object

NO.	Object Function	Name	Data Type	Flag	DPT
295	Locking function	Floor heating	1bit	C,W	1.003 enable
The communication object is used to lock/unlock floor heating function. Telegrams: 0—Lock 1—Unlock					
296	Power on/off	Floor heating	1bit	C,W	1.001 switch
296	Power on/off, status	Floor heating	1bit	C,W,T,U	1.001 switch
When the work mode is “Master” or “Single”, the flag is C,W, “Power on/off” is visible, used to receive telegram from bus to control power on/off. When the work mode is “Slave”, the flag is C,W,T,U, “Power on/off, status” is visible, used to receive the status of power on/off, which is fed back from the controller on the bus. Telegrams: 1—On 0—Off					
297	External temperature sensor	Floor heating	2byte	C,W,T,U	9.001 temperature
The communication object is used to receive the room temperature from the bus, and send read request cyclically, and feedback to screen display.					

298	Current temperature setpoint	Floor heating	2byte	C,W,U	9.001 temperature
298	Current temperature setpoint, status	Floor heating	2byte	C,W,T,U	9.001 temperature
<p>When the work mode is “Master”, the flag is C,W,U, “Current temperature setpoint” is visible, used to modify the current setpoint temperature.</p> <p>When the work mode is “Slave”, the flag is C,W,T,U, “Current temperature setpoint, status” is visible, used to receive the status of current setpoint temperature, which is fed back from the controller on the bus.</p> <p>While “Single”, this object is not visible.</p>					
300	Scene	Floor heating	1byte	C,W	18.001 scene control
<p>The communication object is visible when scene function enabled. Used to recall/storage scene via bus.</p> <p>When the work mode is “Slave”, this object is not visible.</p>					
301	Power on/off, status	Floor heating	1bit	C,R,T	1.001 switch
301	Power on/off	Floor heating	1bit	C,T	1.001 switch
<p>When the work mode is “Master” or “Single”, the flag is C,R,T, “Power on/off, status” is visible, used to feed back status of power on/off to the bus.</p> <p>When the work mode is “Slave”, the flag is C,T, “Power on/off” is visible, used to send the power on/off telegram to bus, to control the controller on the KNX bus.</p>					
302	Actual temperature	Floor heating	2byte	C,R,T	9.001 temperature
<p>The communication object is used for transmitting the actual temperature value detected by the combination temperature sensor of the device to the bus.</p>					
303	Current setpoint adjustment, status	Floor heating	2byte	C,R,T	9.001 temperature
303	Current setpoint adjustment	Floor heating	2byte	C,T	9.001 temperature
<p>When the work mode is “Master”, the flag is C,R,T, “Current setpoint adjustment, status” is visible, used to feed back status of current setpoint temperature to the bus.</p> <p>When the work mode is “Slave”, the flag is C,T, “Current setpoint adjustment” is visible, used to send the current setpoint temperature to bus.</p> <p>While “Single”, this object is not visible.</p>					
304	Heating on/off Heating control value	Floor heating	1bit 1byte	C,T	1.001 switch 5.001 percentage
<p>The communication object is used to send the control value of floor heating to control the switch of floor heating valve. Telegram value is determined by temperature control type.</p>					



1bit telegram value:

1—On

0—Off

1byte telegram value: 0..100%

When the work mode is “Slave”, this object is not visible.

Table 6.5.3 “Floor heating” communication object table

### 6.5.4. “Ventilation” Communication Object

**System is no need to send a status read request when the ventilation function is voltage recovery.**

Number	Name	Object Function	Description	Group Address	Length	C	R	W	T	U	Data Type	Priority
305	Ventilation	Locking function			1 bit	C	-	W	-	-	enable	Low
306	Ventilation	Power on/off, status			1 bit	C	-	W	-	-	switch	Low
307	Ventilation	Fan speed, status			1 byte	C	-	W	-	-	percentage (0..100%)	Low
308	Ventilation	Fan automatic operation, status			1 bit	C	-	W	-	-	enable	Low
309	Ventilation	Heat recovery on/off, status			1 bit	C	-	W	-	-	switch	Low
310	Ventilation	En./Dis. Heat recovery			1 bit	C	-	W	-	-	enable	Low
311	Ventilation	Filter timer counter change			2 bytes	C	-	W	-	-	time (h)	Low
312	Ventilation	Filter timer reset, status			1 bit	C	-	W	-	-	reset	Low
314	Ventilation	Scene			1 byte	C	-	W	-	-	scene control	Low
315	Ventilation	CO2 value			2 bytes	C	-	W	T	U	parts/million (ppm)	Low
316	Ventilation	PM2.5 value			2 bytes	C	-	W	T	U	pulses	Low
317	Ventilation	VOC value			2 bytes	C	-	W	T	U	pulses	Low
318	Ventilation	Power on/off			1 bit	C	-	-	T	-	switch	Low
319	Ventilation	Fan speed			1 byte	C	-	-	T	-	percentage (0..100%)	Low
320	Ventilation	Fan automatic operation			1 bit	C	-	-	T	-	enable	Low
321	Ventilation	Heat recovery on/off			1 bit	C	-	-	T	-	switch	Low
322	Ventilation	Filter timer counter			2 bytes	C	-	-	T	-	time (h)	Low
323	Ventilation	Filter alarm			1 bit	C	-	-	T	-	alarm	Low
324	Ventilation	Filter timer reset			1 bit	C	-	-	T	-	reset	Low

Fig.6.5.4 “Ventilation” communication Object

NO.	Object Function	Name	Data Type	Flag	DPT
<b>305</b>	<b>Locking function</b>	<b>Ventilation</b>	<b>1bit</b>	<b>C,W</b>	<b>1.003 enable</b>
The communication object is used to lock/unlock ventilation function. Telegrams: 0—Lock 1—Unlock					
<b>306</b>	<b>Power on/off, status</b>	<b>Ventilation</b>	<b>1bit</b>	<b>C,W</b>	<b>1.001 switch</b>
The communication object is used to receive the power on/off telegram of ventilation from the bus. Telegrams: 1—On 0—Off					
<b>307</b>	<b>Fan speed, status</b>	<b>Ventilation</b>	<b>1byte</b>	<b>C,W</b>	<b>5.001 percentage</b> <b>5.100 fan stage</b>

The communication object is used to receive the current fan speed from the bus. Telegram value is determined by parameter setting datatype.					
<b>308</b>	<b>Fan automatic operation, status</b>	<b>Ventilation</b>	<b>1bit</b>	<b>C,W</b>	<b>1.003 enable</b>
The communication object is used to receive feedback status of fan automatic operation from the bus. Telegrams: 1—Automatic 0—Cancel automatic					
<b>309</b>	<b>Heat recovery on/off, status</b>	<b>Ventilation</b>	<b>1bit</b>	<b>C,W</b>	<b>1.001 switch</b>
The communication object is used to receive feedback status of heat recovery on/off from the bus. Telegrams: 1—Active 0—Inactive					
<b>310</b>	<b>En./Dis. Heat recovery</b>	<b>Ventilation</b>	<b>1bit</b>	<b>C,W</b>	<b>1.003 enable</b>
The communication object is used to disable/enable heat recovery via the bus.					
<b>311</b>	<b>Filter timer counter change</b>	<b>Ventilation</b>	<b>2byte</b>	<b>C,W</b>	<b>7.007 time(h)</b>
The communication object is used to modify the time length of the filter usage by the bus, the unit is in hours.					
<b>312</b>	<b>Filter timer reset, status</b>	<b>Ventilation</b>	<b>1bit</b>	<b>C,W</b>	<b>1.015 reset</b>
The communication object is used to reset the filter time via the bus, and after the filter is reset, the filter time is used to start counting again. Telegram value: 1—Reset					
<b>314</b>	<b>Scene</b>	<b>Ventilation</b>	<b>1byte</b>	<b>C,W</b>	<b>18.001 scene control</b>
The communication object is visible when scene function enabled. Used to recall/storage scene via bus.					
<b>315</b>	<b>CO2 value</b>	<b>Ventilation</b>	<b>2byte</b>	<b>C,W,T,U</b>	<b>7.001 pulse</b> <b>9.008 parts/million(ppm)</b>
<b>316</b>	<b>PM 2.5 value</b>	<b>Ventilation</b>	<b>2byte</b>	<b>C,W,T,U</b>	<b>7.001 pulse</b> <b>9.030 concentration(ug/m3)</b>
<b>317</b>	<b>VOC value</b>	<b>Ventilation</b>	<b>2byte</b>	<b>C,W,T,U</b>	<b>7.001 pulse</b> <b>9.030 concentration(ug/m3)</b>
These communication objects are used to receive the input of the PM2.5/VOC/CO2 value and get the corresponding value from the bus to be updated to the display in ug/m <sup>3</sup> or ppm. Range:0~999ug/m <sup>3</sup> or 0~4000ppm					

<p>If the control value of the automatic operation is PM2.5, the ventilation system can be set to automatically adjust the fan speed according to the concentration of PM2.5.</p>					
<b>318</b>	<b>Power on/off</b>	<b>Ventilation</b>	<b>1bit</b>	<b>C,T</b>	<b>1.001 switch</b>
<p>The communication object is used to send the power on/off telegram of ventilation, to control ventilation power on/off on the KNX bus. Cancel Auto function at the same time after power-off.</p>					
<b>319</b>	<b>Fan speed</b>	<b>Ventilation</b>	<b>1byte</b>	<b>C,T</b>	<b>5.001 percentage</b> <b>5.100 fan stage</b>
<p>The communication object is used to control fan speed via the screen, and send control telegram of each fan speed to the bus. Telegram value is determined by parameter setting datatype.</p>					
<b>320</b>	<b>Fan automatic operation</b>	<b>Ventilation</b>	<b>1bit</b>	<b>C,T</b>	<b>1.003 enable</b>
<p>The communication object is used to send control telegram of fan automatic operation to the bus. Telegrams:</p> <p>1— Automatic</p> <p>0— Cancel automatic</p>					
<b>321</b>	<b>Heat recovery on/off</b>	<b>Ventilation</b>	<b>1bit</b>	<b>C,T</b>	<b>1.001 switch</b>
<p>The communication object is used to send telegram of heat recovery on/off to the bus. Telegrams:</p> <p>1— Active</p> <p>0— Inactive</p>					
<b>322</b>	<b>Filter timer counter</b>	<b>Ventilation</b>	<b>2byte</b>	<b>C,T</b>	<b>7.007 time(h)</b>
<p>The communication object is used to count the length of the filter, send telegram to the bus when the count value changes. The unit of filter time counter is in hours.</p>					
<b>323</b>	<b>Filter alarm</b>	<b>Ventilation</b>	<b>1bit</b>	<b>C,T</b>	<b>1.005 alarm</b>
<p>When the filter is used for longer than the set value, the communication object sends an alarm to remind the user to replace the filter. Telegram value:</p> <p>1— Alarm</p>					
<b>324</b>	<b>Filter timer reset</b>	<b>Ventilation</b>	<b>1bit</b>	<b>C,W</b>	<b>1.015 reset</b>
<p>The communication object is used to send the filter timer reset status to the bus, and you can also long press button <b>1s</b> to reset.</p>					

Table 6.5.4 “Ventilation” communication object table

## 6.6. “Audio control” Communication Object

When status read request is enabled, and power on/off is disabled, system needs to return to the status as before voltage failure when voltage recovery, and need to send these status requests when restarted: play status, play mode, volume percent, mute, track name, album name, artist name (related function is enabled); When power on/off is enabled, the sending requests are the same with the disabled, but note that status of power on/off is no need to send.

Number	Name	Object Function	Description	Group Address	Length	C	R	W	T	U	Data Type	Priority
325	Audio	Locking function			1 bit	C	-	W	-	-	enable	Low
326	Audio	Power on/off, status			1 bit	C	-	W	-	-	switch	Low
327	Audio	Play, status			1 bit	C	-	W	T	U	enable	Low
328	Audio	Pause, status			1 bit	C	-	W	T	U	enable	Low
329	Audio	Volume, status			1 byte	C	-	W	T	U	percentage (0..100%)	Low
330	Audio	Mute, status			1 bit	C	-	W	T	U	enable	Low
331	Audio	Play mode, status			1 byte	C	-	W	T	U	counter pulses (0..255)	Low
332	Audio	Track name			14 bytes	C	-	W	T	U	Character String (ISO 8859-1)	Low
333	Audio	Album name			14 bytes	C	-	W	T	U	Character String (ISO 8859-1)	Low
334	Audio	Artist name			14 bytes	C	-	W	T	U	Character String (ISO 8859-1)	Low
335	Audio	Power on/off			1 bit	C	-	-	T	-	switch	Low
336	Audio	Play			1 bit	C	-	-	T	-	enable	Low
337	Audio	Pause			1 bit	C	-	-	T	-	enable	Low
338	Audio	Next track			1 bit	C	-	-	T	-	enable	Low
339	Audio	Previous track			1 bit	C	-	-	T	-	enable	Low
340	Audio	Volume+=1/Volume-=0			1 bit	C	-	-	T	-	step	Low
341	Audio	Relative volume adjustment			4 bit	C	-	-	T	-	dimming control	Low
343	Audio	Mute			1 bit	C	-	-	T	-	enable	Low
344	Audio	Play mode			1 byte	C	-	-	T	-	counter pulses (0..255)	Low

Fig.6.6 “Audio control” communication Object

NO.	Object Function	Name	Data Type	Flag	DPT
325	Locking function	Audio	1bit	C,W	1.003 enable
The communication object is used to lock/unlock audio control function. Telegrams: 0——Lock 1——Unlock					
326	Power on/off, status	Audio	1bit	C,W	1.001 switch
The communication object is visible when power on/off is enabled. Used to receive the status feedback of on/off in audio module from bus, and feed back to screen display.					
327	Play=1/Pause=0, status	Audio	1bit	C,W,T,U	1.010 start/stop
The communication object is visible when control play/pause with one object. Used to receive the status feedback of play/pause in audio module from bus, and feed back to screen display.					
327	Play, status	Audio	1bit	C,W,T,U	1.003 enable
The communication object is visible when control play/pause with two separate objects. Used to receive the status feedback of play in audio module from bus, and feed back to screen display. Telegram 1 is to play, 0 is meaningless.					

328	Pause, status	Audio	1bit	C,W,T,U	1.003 enable
<p>The communication object is visible when control play/pause with two separate objects. Used to receive the status feedback of pause in audio module from bus, and feed back to screen display.</p> <p>Telegram 1 is to stop, 0 is meaningless.</p>					
329	Volume, status	Audio	1byte	C,W,T,U	5.001 percentage (0..100%) 5.004 percentage (0..255%)
<p>The communication object is used to receive the volume status in audio module, and feed back to screen display. Telegrams value is according to different object types: 0..100 / 0..255</p>					
330	Mute, status	Audio	1bit	C,W,T,U	1.003 enable
<p>The communication object is visible when mute is enabled. Used to receive the mute status of the audio module from the bus, and feed back to screen display.</p>					
331	Play mode, status	Audio	1byte	C,W,T,U	5.010 counter pluses(0..255)
<p>The communication object is used to receive the status feedback of play mode in the audio module, the receiving telegrams should be preset by parameters before the display status on the screen can be updated.</p>					
332	Track name	Audio	14byte	C,W,T,U	16.001 character string (ISO 8859-1)
<p>The communication object is used to receive the track name via the bus, and display on the screen.</p>					
333	Album name	Audio	14byte	C,W,T,U	16.001 character string (ISO 8859-1)
<p>The communication object is used to receive the album name via the bus, and display on the screen.</p>					
334	Artist name	Audio	14byte	C,W,T,U	16.001 character string (ISO 8859-1)
<p>The communication object is used to receive the artist name via the bus, and display on the screen.</p>					
335	Power on/off	Audio	1bit	C,T	1.001 switch
<p>The communication object is visible when power on/off is enabled. Used to send the telegram to the bus.</p> <p>Telegrams:</p> <p style="padding-left: 40px;">1——On</p> <p style="padding-left: 40px;">0——Off</p>					
336	Play=1/Pause=0	Audio	1bit	C,T	1.010 start/stop
<p>The communication object is visible when control play/pause with one object. Used to play/stop the music in the audio module. Telegrams:</p> <p style="padding-left: 40px;">1——Play music</p> <p style="padding-left: 40px;">0——Pause playing music</p>					
336	Play	Audio	1bit	C,T	1.003 enable

The communication object is visible when control play/pause with two separate objects. Used to play the music in the audio module. Telegram 1 is to play, 0 is meaningless.					
337	Pause	Audio	1bit	C,T	1.003 enable
The communication object is visible when control play/pause with two separate objects. Used to stop the music in the audio module. Telegram 1 is to stop, 0 is meaningless.					
338	Next track=1/Previous track=0	Audio	1bit	C,T	1.007 step
The communication object is visible when control next track/previous track with one object. Used to switch the playing song of the audio module, to switch the previous song/the next song. Telegrams: 1——Play the next song 0——Play the previous song					
338	Next track	Audio	1bit	C,T	1.003 enable
The communication object is visible when control next track/previous track with two separate objects. Used to switch the playing song of the audio module, to switch the next song. Telegram 1 is to play next song, 0 is meaningless.					
339	Previous track	Audio	1bit	C,T	1.003 enable
The communication object is visible when control next track/previous track with two separate objects. Used to switch the playing song of the audio module, to switch the previous song. Telegram 1 is play the previous song, 0 is meaningless.					
340	Volume+=1/Volume-=0	Audio	1bit	C,T	1.007 step
The communication object is used to adjust the volume in audio module when short operation. Telegrams: 1——Increase volume 0——Decrease volume					
341	Relative volume adjustment	Audio	4bit	C,T	3.007 dimming
The communication object is visible when relative adjustment. Used to adjust the volume in audio module when long operation, step value is determined by the parameter.					
342	Absolute volume adjustment	Audio	1byte	C,T	5.001 percentage (0..100%) 5.004 percentage (0..255%)
The communication object is visible when absolute adjustment. Used to adjust the volume in audio module when long operation, step value is determined by the parameter. Telegram is determined by different object datatype: 0..100 / 0..255					
343	Mute	Audio	1bit	C,T	1.003 enable

<p>The communication object is visible when mute is enabled. Used to control mute of audio module via the button. Telegrams:</p> <p style="padding-left: 40px;">1—Mute</p> <p style="padding-left: 40px;">0—Cancel mute</p>					
<b>344</b>	<b>Play mode</b>	<b>Audio</b>	<b>1byte</b>	<b>C,T</b>	<b>5.010 counter pluses(0..255)</b>
<p>The communication object is used to send control telegram of the audio module play mode, different mode telegrams are preset by parameters.</p>					

Table 6.6 “Audio control” communication object table

## 6.7. “Logic” Communication Object

### 6.7.1. “AND/OR/XOR” Communication Object

Number	Name	Object Function	Description	Group Address	Length	C	R	W	T	U	Data Type	Priority
11	1st Logic	Input a			1 bit	C	-	W	T	U	boolean	Low
12	1st Logic	Input b			1 bit	C	-	W	T	U	boolean	Low
13	1st Logic	Input c			1 bit	C	-	W	T	U	boolean	Low
14	1st Logic	Input d			1 bit	C	-	W	T	U	boolean	Low
15	1st Logic	Input e			1 bit	C	-	W	T	U	boolean	Low
16	1st Logic	Input f			1 bit	C	-	W	T	U	boolean	Low
17	1st Logic	Input g			1 bit	C	-	W	T	U	boolean	Low
18	1st Logic	Input h			1 bit	C	-	W	T	U	boolean	Low
19	1st Logic	Logic result			1 bit	C	-	-	T	-	boolean	Low

Fig.6.7.1 “AND/OR/XOR” communication Object

NO.	Object Function	Name	Data Type	Flag	DPT
11/.../18	<b>Input x</b>	{{1st Logic}}	<b>1bit</b>	<b>C,W,T,U</b>	<b>1.002 boolean</b>
<p>The communication object is used to receive the value of logical input Input x.</p> <p>The name in parentheses changes with the parameter “Description for logic function”. If description is empty, display “1st Logic” by default. The same below.</p>					
19	<b>Logic result</b>	{{1st Logic}}	<b>1bit</b>	<b>C,T</b>	<b>1.002 boolean</b>
<p>The communication object is used to send the results of logical operation.</p>					

Table 6.7.1 “AND/OR/XOR” communication object table

### 6.7.2. “Gate forwarding” Communication Object

Number	Name	Object Function	Description	Group Address	Length	C	R	W	T	U	Data Type	Priority
11	1st Logic	Gate value select			1 byte	C	-	W	-	-	scene number	Low
12	1st Logic	Input A			1 bit	C	-	W	-	-	switch	Low
13	1st Logic	Input B			1 bit	C	-	W	-	-	switch	Low
14	1st Logic	Input C			1 bit	C	-	W	-	-	switch	Low
15	1st Logic	Input D			1 bit	C	-	W	-	-	switch	Low
16	1st Logic	Output A			1 bit	C	-	-	T	-	switch	Low
17	1st Logic	Output B			1 bit	C	-	-	T	-	switch	Low
18	1st Logic	Output C			1 bit	C	-	-	T	-	switch	Low
19	1st Logic	Output D			1 bit	C	-	-	T	-	switch	Low

Fig.6.7.2 “Gate forwarding” communication Object

NO.	Object Function	Name	Data Type	Flag	DPT
11	<b>Gate value select</b>	{{1st Logic}}	<b>1byte</b>	<b>C,W</b>	<b>17.001 scene number</b>
<p>The communication object is used to select the scene of logical gate forwarding.</p>					
12/.../15	<b>Input x</b>	{{1st Logic}}	<b>1bit</b> <b>4bit</b> <b>1byte</b>	<b>C,W</b>	<b>1.001 switch</b> <b>3.007 dimming control</b> <b>5.010 counter pulses(0..255)</b>
<p>The communication object is used to receive the value of the logic gate input Input x.</p>					



16/..19	Output x	{{1st Logic}}	1bit 4bit 1byte	C,T	1.001 switch 3.007 dimming control 5.010 counter pulses(0..255)
<p>The communication object is used to output the value forwarded by the logic gate. The output value is the same as the input value, but one input can be forwarded into one or more outputs, set by parameters.</p>					

Table 6.7.2 “Gate forwarding” communication object table

### 6.7.3. “Threshold comparator” Communication Object

Number	Name	Object Function	Description	Group Address	Length	C	R	W	T	U	Data Type	Priority
11	1st Logic	Threshold value input			4 bit	C	-	W	-	U	dimming control	Low
11	1st Logic	Threshold value input			1 byte	C	-	W	-	U	counter pulses (0..255)	Low
11	1st Logic	Threshold value input			2 bytes	C	-	W	-	U	pulses	Low
11	1st Logic	Threshold value input			2 bytes	C	-	W	-	U	2-byte signed value	Low
11	1st Logic	Threshold value input			2 bytes	C	-	W	-	U	2-byte float value	Low
11	1st Logic	Threshold value input			4 bytes	C	-	W	-	U	counter pulses (unsigned)	Low
11	1st Logic	Threshold value input			2 bytes	C	-	W	-	U	temperature (°C)	Low
11	1st Logic	Threshold value input			2 bytes	C	-	W	-	U	humidity (%)	Low
11	1st Logic	Threshold value input			2 bytes	C	-	W	-	U	lux (Lux)	Low
19	1st Logic	Logic result			1 bit	C	-	-	T	-	boolean	Low

Fig.6.7.3 “Threshold comparator” communication Object

NO.	Object Function	Name	Data Type	Flag	DPT
11	Threshold value input	{{1st Logic}}	4bit 1byte 2byte 4byte	C,W, U	3.007 dimming 5.010 counter pulses 7.001 pulses 12.001 counter pulses
<p>The communication object is used to input threshold value.</p>					
19	Logic result	{{1st Logic}}	1bit	C,T	1.002 boolean
<p>The communication object is used to send the results of logical operation. That is, the value that should be sent after the object input threshold is compared with the setting threshold value.</p>					

Table 6.7.3 “Threshold comparator” communication object table

### 6.7.4. “Format convert” Communication Object

Number	Name	Object Function	Description	Group Address	Length	C	R	W	T	U	Data Type	Priority
11	1st Logic	Input 1bit-bit0			1 bit	C	-	W	-	U	boolean	Low
12	1st Logic	Input 1bit-bit1			1 bit	C	-	W	-	U	boolean	Low
19	1st Logic	Output 2bit			2 bit	C	-	-	T	-	switch control	Low

“2x1bit --> 1x2bit”function: converts two 1bit values to a 2bit value, such as Input bit1=1, bit0=0--> Output 2bit=2

Number	Name	Object Function	Description	Group Address	Length	C	R	W	T	U	Data Type	Priority
11	1st Logic	Input 1bit-bit0			1 bit	C	-	W	-	U	boolean	Low
12	1st Logic	Input 1bit-bit1			1 bit	C	-	W	-	U	boolean	Low
13	1st Logic	Input 1bit-bit2			1 bit	C	-	W	-	U	boolean	Low
14	1st Logic	Input 1bit-bit3			1 bit	C	-	W	-	U	boolean	Low
15	1st Logic	Input 1bit-bit4			1 bit	C	-	W	-	U	boolean	Low
16	1st Logic	Input 1bit-bit5			1 bit	C	-	W	-	U	boolean	Low
17	1st Logic	Input 1bit-bit6			1 bit	C	-	W	-	U	boolean	Low
18	1st Logic	Input 1bit-bit7			1 bit	C	-	W	-	U	boolean	Low
19	1st Logic	Output 1byte			1 byte	C	-	-	T	-	counter pulses (0..255)	Low

“8x1bit --> 1x1byte”function: converts eight 1bit values to a 1byte value, such as Input bit2=1, bit1=1, bit0=1, other bits are 0--> Output 1byte=7

Number	Name	Object Function	Description	Group Address	Length	C	R	W	T	U	Data Type	Priority
11	1st Logic	Input 1byte			1 byte	C	-	W	-	U	counter pulses (0..255)	Low
19	1st Logic	Output 2byte			2 bytes	C	-	-	T	-	pulses	Low

“1x1byte --> 1x2byte”function: converts one 1byte values to a 2byte value, such as Input 1byte=125--> Output 2byte=125. Although the value remains the same, the data type of the value is different.

Number	Name	Object Function	Description	Group Address	Length	C	R	W	T	U	Data Type	Priority
11	1st Logic	Input 1byte-low			1 byte	C	-	W	-	U	counter pulses (0..255)	Low
12	1st Logic	Input 1byte-high			1 byte	C	-	W	-	U	counter pulses (0..255)	Low
19	1st Logic	Output 2byte			2 bytes	C	-	-	T	-	pulses	Low

“2x1byte --> 1x2byte”function: converts two 1byte values to a 2byte value, such as Input 1byte-low = 255 (\$FF), Input 1byte-high = 100 (\$64) --> Output 2byte = 25855 (\$64 FF)

Number	Name	Object Function	Description	Group Address	Length	C	R	W	T	U	Data Type	Priority
11	1st Logic	Input 2byte-low			2 bytes	C	-	W	-	U	pulses	Low
12	1st Logic	Input 2byte-high			2 bytes	C	-	W	-	U	pulses	Low
19	1st Logic	Output 4byte			4 bytes	C	-	-	T	-	counter pulses (unsigned)	Low

“2x2byte --> 1x4byte”function: converts two 2 byte values to a 4byte value, such as Input 2byte-low = 65530 (\$FF FA), Input 2byte-high = 32768 (\$80 00)--> Output 2byte = 2147549178 (\$80 00 FF FA)

Number	Name	Object Function	Description	Group Address	Length	C	R	W	T	U	Data Type	Priority
11	1st Logic	Input 1byte			1 byte	C	-	W	-	U	counter pulses (0..255)	Low
12	1st Logic	Output 1bit-bit0			1 bit	C	-	-	T	-	boolean	Low
13	1st Logic	Output 1bit-bit1			1 bit	C	-	-	T	-	boolean	Low
14	1st Logic	Output 1bit-bit2			1 bit	C	-	-	T	-	boolean	Low
15	1st Logic	Output 1bit-bit3			1 bit	C	-	-	T	-	boolean	Low
16	1st Logic	Output 1bit-bit4			1 bit	C	-	-	T	-	boolean	Low
17	1st Logic	Output 1bit-bit5			1 bit	C	-	-	T	-	boolean	Low
18	1st Logic	Output 1bit-bit6			1 bit	C	-	-	T	-	boolean	Low
19	1st Logic	Output 1bit-bit7			1 bit	C	-	-	T	-	boolean	Low

“1x1byte --> 8x1bit” function: converts one 1byte values to eight 1bit value, such as Input 1byte=200 --> Output bit0=0, bit1=0, bit2=0, bit3=1, bit4=0, bit5=0, bit6=1, bit7=1

Number	Name	Object Function	Description	Group Address	Length	C	R	W	T	U	Data Type	Priority
11	1st Logic	Input 2byte			2 bytes	C	-	W	-	U	pulses	Low
18	1st Logic	Output 1byte-low			1 byte	C	-	-	T	-	counter pulses (0..255)	Low
19	1st Logic	Output 1byte-high			1 byte	C	-	-	T	-	counter pulses (0..255)	Low

“1x2byte --> 2x1byte”function: converts one 2byte values to two 2byte value, such as Input 2byte = 55500 (\$D8 CC) --> Output 1byte-low = 204 (\$CC), Output 1byte-high =216 (\$D8)

Number	Name	Object Function	Description	Group Address	Length	C	R	W	T	U	Data Type	Priority
11	1st Logic	Input 4byte			4 bytes	C	-	W	-	U	counter pulses (unsigned)	Low
18	1st Logic	Output 2byte-low			2 bytes	C	-	-	T	-	pulses	Low
19	1st Logic	Output 2byte-high			2 bytes	C	-	-	T	-	pulses	Low

“1x4byte --> 2x2byte”function: converts one 4byte values to two 2byte value, such as Input 4byte = 78009500 (\$04 A6 54 9C) --> Output 2byte-low = 21660 (\$54 9C), Output 2byte-high =1190 (\$04 A6)

Number	Name	Object Function	Description	Group Address	Length	C	R	W	T	U	Data Type	Priority
11	1st Logic	Input 3byte			3 bytes	C	-	W	-	U	RGB value 3x(0..255)	Low
17	1st Logic	Output 1byte-low			1 byte	C	-	-	T	-	counter pulses (0..255)	Low
18	1st Logic	Output 1byte-middle			1 byte	C	-	-	T	-	counter pulses (0..255)	Low
19	1st Logic	Output 1byte-high			1 byte	C	-	-	T	-	counter pulses (0..255)	Low

“1x3byte --> 3x1byte”function: converts one 3byte values to three 1byte value, such as Input 3byte = \$78 64 C8--> Output 1byte-low = 200 (\$C8) , Output 1byte-middle = 100 (\$64) , Output 1byte-high =120 (\$78)

Number	Name	Object Function	Description	Group Address	Length	C	R	W	T	U	Data Type	Priority
11	1st Logic	Input 1byte-low			1 byte	C	-	W	-	U	counter pulses (0..255)	Low
12	1st Logic	Input 1byte-middle			1 byte	C	-	W	-	U	counter pulses (0..255)	Low
13	1st Logic	Input 1byte-high			1 byte	C	-	W	-	U	counter pulses (0..255)	Low
19	1st Logic	Output 3byte			3 bytes	C	-	-	T	-	RGB value 3x(0..255)	Low

“3x1byte --> 1x3byte”function: converts three 1byte values to a 3byte value, such as Input 1byte-low = 150 (\$96), Input 1byte-middle = 100 (\$64), Input 1byte-high = 50 (\$32)--> Output 3byte = \$32 64 96

Fig.6.7.4 “Format convert” communication Object

NO.	Object Function	Name	Data Type	Flag	DPT
11	Input ...	{{1st Logic}}	1bit	C,W,U	1.001 switch
			1byte		5.010 counter pulses(0..255)
			2byte		7.001 pulses
			3byte		232.600 RGB value 3x(0..255)
			4byte		12.001 counter pulses
The communication object is used to input a value that needs to be converted.					
19	Output ...	{{1st Logic}}	1bit	C,T	1.001 switch
			2bit		2.001 switch control
			1byte		5.010 counter pulses(0..255)
			2byte		7.001 pulses
			3byte		232.600 RGB value 3x(0..255)
4byte	12.001 counter pulses				
The communication object is used to output the converted value.					

Table 6.7.4 “Format convert” communication object table

### 6.7.5. “Gate function” Communication Object

Number	Name	Object Function	Description	Group Address	Length	C	R	W	T	U	Data Type	Priority
11	1st Logic	Input			1 bit	C	-	W	-	-	switch	Low
12	1st Logic	Gate input			1 bit	C	-	W	-	-	boolean	Low
19	1st Logic	Output			1 bit	C	-	-	T	-	switch	Low
Input/Output - 1bit[On/Off]												
11	1st Logic	Input			1 byte	C	-	W	-	-	percentage (0..100%)	Low
12	1st Logic	Gate input			1 bit	C	-	W	-	-	boolean	Low
19	1st Logic	Output			1 byte	C	-	-	T	-	percentage (0..100%)	Low
Input/Output - 1byte[0..100%]												
11	1st Logic	Input			1 byte	C	-	W	-	-	counter pulses (0..255)	Low
12	1st Logic	Gate input			1 bit	C	-	W	-	-	boolean	Low
19	1st Logic	Output			1 byte	C	-	-	T	-	counter pulses (0..255)	Low
Input/Output - 1byte[0..255]												
11	1st Logic	Input			2 bytes	C	-	W	-	-	temperature (°C)	Low
12	1st Logic	Gate input			1 bit	C	-	W	-	-	boolean	Low
19	1st Logic	Output			2 bytes	C	-	-	T	-	temperature (°C)	Low
Input/Output - 2byte[Float]												
11	1st Logic	Input			2 bytes	C	-	W	-	-	pulses	Low
12	1st Logic	Gate input			1 bit	C	-	W	-	-	boolean	Low
19	1st Logic	Output			2 bytes	C	-	-	T	-	pulses	Low
Input/Output - 2byte[0..65535]												

Fig.6.7.5 “Gate function” communication Object

NO.	Object Function	Name	Data Type	Flag	DPT
11	Input	{{1st Logic}}	1bit 1byte 2byte	C,W	1.001 switch 5.001 percentage 5.010 counter pulses 9.001 temperature 7.001 pulses
The communication object is used to input a value that needs to gate filter.					
12	Gate input	{{1st Logic}}	1bit	C,W	1.002 boolean
The communication object is used to control the switch status of gate input. Input signal is allowed to pass when gate open, then output, and the current input status is still sent if there is a change; Can not pass when gate close.					
13	Output	{{1st Logic}}	bit 1byte 2byte	C,T	1.001 switch 5.001 percentage 5.010 counter pulses 9.001 temperature 7.001 pulses
The communication object is used to output the value after gate filtering. Only when gate input status is open, output is available, defined by the object “Gate input”.					

Table 6.8.5 “Gate function” communication object table

### 6.7.6. “Delay function” Communication Object

Number	Name	Object Function	Description	Group Address	Length	C	R	W	T	U	Data Type	Priority
11	1st Logic	Input			1 bit	C	-	W	-	-	switch	Low
19	1st Logic	Output			1 bit	C	-	-	T	-	switch	Low
Input/Output - 1 bit[On/Off]												
11	1st Logic	Input			1 byte	C	-	W	-	-	percentage (0..100%)	Low
19	1st Logic	Output			1 byte	C	-	-	T	-	percentage (0..100%)	Low
Input/Output - 1 byte[0..100%]												
11	1st Logic	Input			1 byte	C	-	W	-	-	counter pulses (0..255)	Low
19	1st Logic	Output			1 byte	C	-	-	T	-	counter pulses (0..255)	Low
Input/Output - 1 byte[0..255]												
11	1st Logic	Input			2 bytes	C	-	W	-	-	temperature (°C)	Low
19	1st Logic	Output			2 bytes	C	-	-	T	-	temperature (°C)	Low
Input/Output - 2 byte[Float]												
11	1st Logic	Input			2 bytes	C	-	W	-	-	pulses	Low
19	1st Logic	Output			2 bytes	C	-	-	T	-	pulses	Low
Input/Output - 2 byte[0..65535]												

Fig.6.7.6 “Delay function” communication Object

NO.	Object Function	Name	Data Type	Flag	DPT
11	Input	{{1st Logic}}	1bit 1byte 2byte	C,W	1.001 switch 5.001 percentage 5.010 counter pulses 9.001 temperature 7.001 pulses
The communication object is used to input a value that needs to delay.					
19	Output	{{1st Logic}}	1bit 1byte 2byte	C,T	1.001 switch 5.001 percentage 5.010 counter pulses 9.001 temperature 7.001 pulses
The communication object is used to output that needs to delay converted value, delay time is defined by the parameter.					

Table 6.7.6 “Delay function” communication object table

### 6.7.7. “Staircase lighting” Communication Object

Number	Name	Object Function	Description	Group Address	Length	C	R	W	T	U	Data Type	Priority
11	1st Logic	Trigger value			1 bit	C	-	W	-	-	trigger	Low
12	1st Logic	Light-on duration time			2 bytes	C	-	W	-	-	time (s)	Low
19	1st Logic	Output			1 bit	C	-	-	T	-	switch	Low
19	1st Logic	Output			1 byte	C	-	-	T	-	counter pulses (0..255)	Low

Fig.6.7.7 “Staircase lighting” communication Object

NO.	Object Function	Name	Data Type	Flag	DPT
11	Trigger value	{{1st Logic}}	1bit	C,W	1.017 trigger
The communication object is used to receive the value to trigger staircase lighting.					



12	Light-on duration time	{{1st Logic}}	2byte	C,W	7.005 time(s)
The communication object is used to modify the staircase light-on duration time, the modified range is referenced from the range defined by the parameter, take the limit value if exceeded.					
19	Output	{{1st Logic}}	1bit 1byte	C,T	1.001 switch 5.010 counter pulses
The communication object is used to output value 1 when trigger, and send value 2 after duration time. Telegram value is determined by the parameter setting datatype.					

Table 6.7.7 “Staircase lighting” communication object table

## 6.8. “Scene Group” Communication Object

Number	Name	Object Function	Description	Group Address	Length	C	R	W	T	U	Data Type	Priority
83	Scene Group	Main scene trigger			1 byte	C	-	W	-	-	scene number	Low
84	1st Scene Group-Output 1	1bit value			1 bit	C	-	-	T	-	switch	Low
92	2nd Scene Group-Output 1	1bit value			1 bit	C	-	-	T	-	switch	Low
100	3rd Scene Group-Output 1	1bit value			1 bit	C	-	-	T	-	switch	Low
108	4th Scene Group-Output 1	1bit value			1 bit	C	-	-	T	-	switch	Low
116	5th Scene Group-Output 1	1bit value			1 bit	C	-	-	T	-	switch	Low
124	6th Scene Group-Output 1	1bit value			1 bit	C	-	-	T	-	switch	Low
132	7th Scene Group-Output 1	1bit value			1 bit	C	-	-	T	-	switch	Low
140	8th Scene Group-Output 1	1bit value			1 bit	C	-	-	T	-	switch	Low

Fig.6.8 “Scene Group” communication Object

NO.	Object Function	Name	Data Type	Flag	DPT
83	Main scene trigger	Scene Group	1byte	C,W	17.001 scene number
This communication object triggers each output in the scene group to send a specific value to the bus by recalling the scene number. Telegrams: 0.. 63					
84/..	1bit value 1byte unsigned value HVAC mode 2byte unsigned value Temperature	1st Scene Group-{{Output x}}	1bit 1byte 2byte	C,T	1.001 switch 5.010 counter pulses 20.102 HVAC mode 7.001 pulses 9.001 temperature
When a scene is recalled, the communication object is used to send the corresponding output value of the scene to the bus. If the output is not set to this scene, it will not be sent. A total of 8 scene groups can be set up, with 8 outputs per group. The name in parentheses changes with the parameter “Description for logic function”. If description is empty, display “1st Scene Group-Output x” by default. The same below.					

Table 6.8 “Scene Group” communication object table

## Chapter 7 UI Description

Push Button Sensor with LCD, 55mm is achieved by the 6 buttons on the panel (as shown in the figure below), and the buttons have different usages when different functions. The button operations also can be referred on ETS interface.



Chapters as follow explain the user interfaces separately according to each function.

### 7.1. Push button sensor

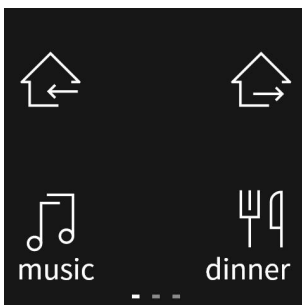

Fig.7.1(1)



Fig.7.1(2)

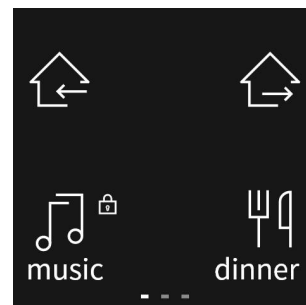

Fig.7.1(3)

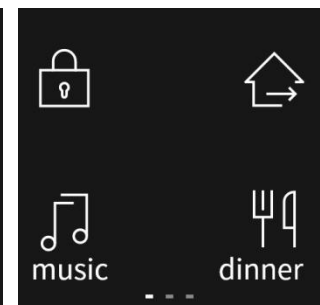

Fig.7.1(4)

**Note: the time of long operation is configured on General interface.**

You can set 1 page with 4 buttons, 2 pages with 8 buttons, or 3 pages with 12 buttons.

When 1 page is selected, the 2 buttons on the bottom of the device (Button 5 and Button 6) only support the scene function. When 2 pages or 3 pages is selected, the 2 buttons on the bottom of the device are used to switch function pages.

#### When used as individual button:

You can only set the left and right fields separately. Each button can be configured with different indication types, including icon, description or icon + description. Colour of icon is set by the parameter. As shown as Fig.7.1(1).

## **When used as rocker button:**

You can set the left, middle and right field separately. The middle field is status indication, with the indication types about icon, description, icon + description, status value or icon+status value; While the left and right fields only can be set as icon or description, and flash twice times (0.5s on and 0.5s off) when press the button, if there is another press during the flashing cycle, not reset the cycle. Colour of icon is set by the parameter. As shown as Fig.7.1(2).

### **Note:**

**When enabled flashing function for switch, dimming or blind functions, there will be different flashing effects when pressing buttons depending on the configured indication type: continuous flashing (1s on and 1s off) when icon or description is selected; only icon flashing when “Icon + description” is selected; while the other selection is to flash icon or description or status value, which is according to configuration.**

**For rocker button, flashing function is only applied to middle field, and the left/right field will not flash when flashing function enabled.**

Display the lock icon when button is disabled, which is configured the indication type via the parameter. Small icon is as shown as Fig.7.1(3), and big icon is as shown as Fig.7.1(4).

For RGB dimming, RGBW dimming or colour temperature dimming, long press the button to enter sub dimming interface. UI for these three function is explained as follow.



**7.1.1.RGB dimming**

Button operations as follow:



Button1	press to select to adjust H (hue) value	Button2	press to select to adjust S (saturation) value
Button3	press to select to adjust V (value) value	Button4	NA
Button5	press to decrease value	Button6	press to increase value

Page as follow:

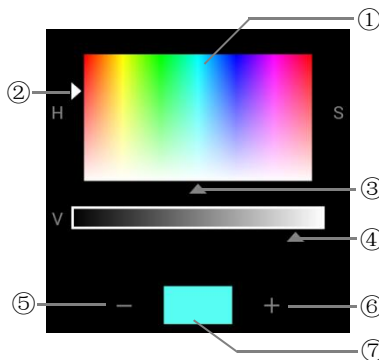

Fig.7.1.1

- ①This area is colour adjustment range.
- ②This is the arrow icon to adjust saturation, it is white when selected, otherwise it is gray.
- ③This is the arrow icon to adjust hue, it is white when selected, otherwise it is gray.
- ④This is the arrow icon to adjust value, it is white when selected, otherwise it is gray. The upper bar is the area for brightness adjustment.
- ⑤Decrease selected value by the button corresponding to this icon, and the arrow will move with the operation.
- ⑥Increase selected value by the button corresponding to this icon, and the arrow will move with the operation.
- ⑦This area displays the effect of colour setting.

**7.1.2.RGBW dimming**

Button operations as follow:



Button1	press to select to adjust H (hue) value	Button2	press to select to adjust S (saturation) value
Button3	press to select to adjust V (value) value	Button4	press to select to adjust W (white brightness) value
Button5	press to decrease value	Button6	press to increase value

Page as follow:

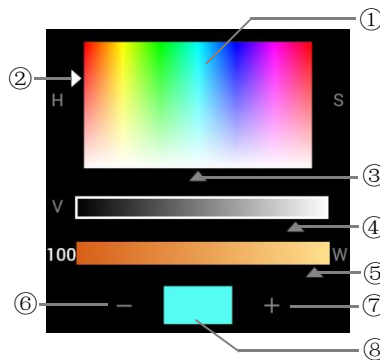

Fig.7.1.2

- ①This area is colour adjustment range.
- ②This is the arrow icon to adjust saturation, it is white when selected, otherwise it is gray.
- ③This is the arrow icon to adjust hue, it is white when selected, otherwise it is gray.
- ④This is the arrow icon to adjust value, it is white when selected, otherwise it is gray. The upper bar is the area for brightness adjustment.
- ⑤This is the arrow icon to adjust white brightness, it is white when selected, otherwise it is gray. The upper bar is the area for white brightness adjustment.
- ⑥Decrease selected value by the button corresponding to this icon, and the arrow will move with the operation.
- ⑦Increase selected value by the button corresponding to this icon, and the arrow will move with the operation.
- ⑧This area displays the effect of colour setting.

### 7.1.3. Colour temperature dimming

Button operations as follow:



Button1	press to decrease colour temperature	Button2	press to increase colour temperature
Button3	press to decrease brightness	Button4	press to increase brightness
Button5	NA	Button6	NA

Page as follow:

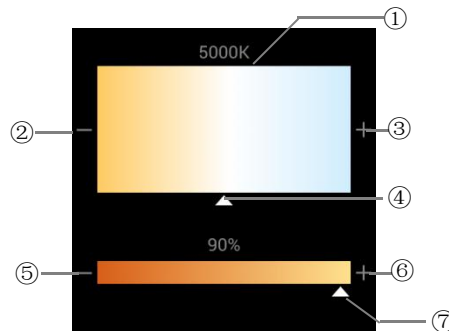

Fig.7.1.3

①This area is colour temperature adjustment range, and current colour temperature is displayed above.

②Decrease colour temperature by the button corresponding to this icon.

③Increase colour temperature by the button corresponding to this icon.

④This is the arrow icon to adjust colour temperature, and the arrow will move with the operation of ②③.

⑤Decrease brightness by the button corresponding to this icon.

⑥Increase brightness by the button corresponding to this icon.

⑦This is the arrow icon to adjust brightness, and the arrow will move with the operation of ⑤⑥.

The upper bar is the area for brightness adjustment, and current brightness is displayed above the bar.

## 7.2. Multifunction thermostat

### 7.2.1.FCU control page

Button operations as follow:

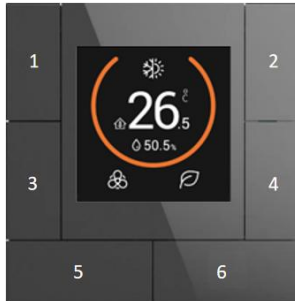

Button1	Press to power off	Button2	if enable multiple functions, press to switchover function page
Button3	Short press to switch fan speed Long press to switch auto mode	Button4	if operation mode disable, press to switch heating/cooling mode; if operation mode enable, short press to switch operation mode, long press to switch heating/cooling mode
Button5	press to decrease temperature	Button6	press to increase temperature

**Note: the time of long operation is configured on General interface.**

Page as follow:

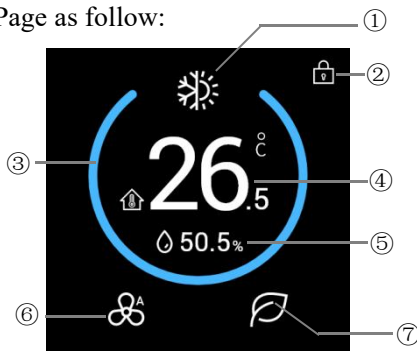

Fig.7.2.1(1)



Fig.7.2.1(2)

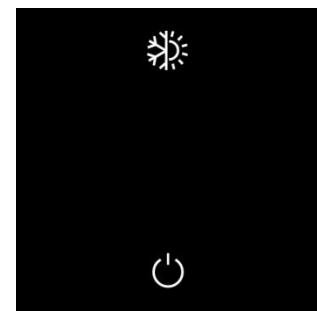



Fig.7.2.1(3)

When device is on, display the temperature and humidity, control mode, room operation mode, fan speed and other status, according to the ETS configuration. When it is off, function interface is shown as Fig.7.2.1(3).

①This area displays function page icon. Icon is configured via ETS.

②This area displays locked status of function page, display  when locked, as shown as Fig.7.2.1(1).





The locked function page cannot be operated except receiving telegram from the bus. The locked is only

apply to the current function page, and has no effect on switching between each function page. You can lock or unlock the function page via the bus.

③**This ring is indicated the current control mode, different colour is different mode. As shown as Fig.7.2.1(1)~7.2.1(2):**

Blue: cooling; Orange: heating.

④**This area displays setpoint temperature or actual temperature, which is configured via ETS. Actual temperature has not received data is shown nothing.**

Icon definition in the lower-left corner: Room temperature ; External temperature ; Combined temperature ; Setpoint temperature .

When display actual temperature, switch automatically to setpoint temperature when adjust via the button, the adjustment step is 0.5K or 1K, which is configured via ETS. Exit the setting after finishing setpoint temperature adjustment, and display actual temperature.

When the setpoint temperature unit is set to degrees Celsius(°C), adjustment range of the setpoint temperature is 5~37°C by default; when the setpoint temperature unit is set to Fahrenheit(°F), the current temperature value will automatically convert to Fahrenheit value, adjustment range of the setpoint temperature is 41~98°F by default. The temperature adjustment range can be modified through parameter setting.

⑤**This area displays humidity. It is configured via ETS.**

⑥**This area displays fan speed level, switch circularly via short press the button:**

 Off,  Low,  Middle,  High,  Auto.

⑦**When activate operation mode on ETS, this area display room operation mode, switch circularly via short press the button:**

 Comfort mode,  Standby mode,  Economy mode,  Protection mode.

**7.2.2.VRF control page**

Button operations as follow:

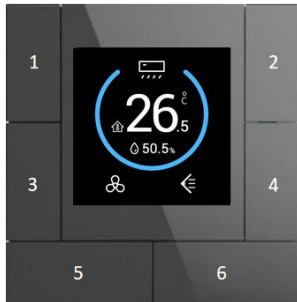

Button1	Press to power off	Button2	if enable multiple functions, press to switchover function page
Button3	short press to switch fan speed long press to switch swing status	Button4	press to switch mode
Button5	press to decrease temperature	Button6	press to increase temperature

**Note: the time of long operation is configured on General interface.**

Page as follow:



Fig.7.2.2(1)



Fig.7.2.2(2)



Fig.7.2.2(3)

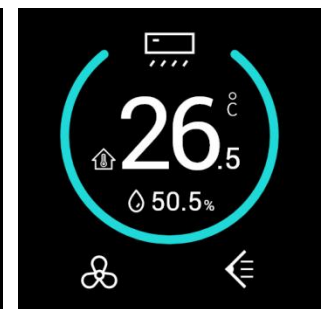

Fig.7.2.2(4)

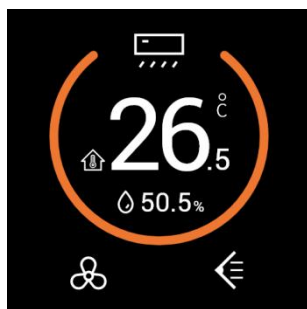

Fig.7.2.2(5)

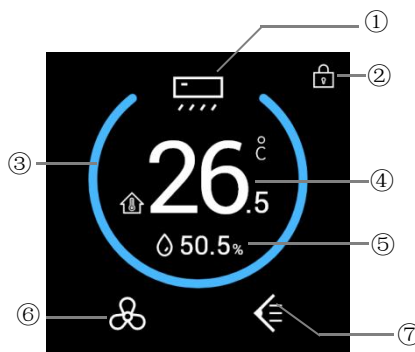

Fig.7.2.2(6)

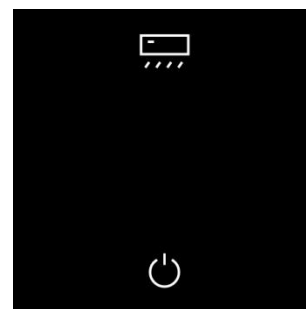



Fig.7.2.2(7)

When device is on, display the temperature and humidity, control mode, fan speed, vanes swing and other status, according to the ETS configuration. When it is off, function interface is shown as Fig.7.2.2(7).

①This area displays function page icon. Icon is configured via ETS.





②This area displays locked status of function page, display  when locked, as shown as Fig.7.2.2(6).

The locked function page cannot be operated except receiving telegram from the bus. The locked is only apply to the current function page, and has no effect on switching between each function page. You can lock or unlock the function page via the bus.

③This ring is indicated the current mode, different colour is different mode. As shown as Fig.7.2.2(1)~7.2.2(6):

White: mode is uncertain; Yellow: Dehumidification; Purple: Auto; Green: Fan; Blue: cooling; Orange: heating.

④This area displays setpoint temperature or actual temperature, which is configured via ETS. Actual temperature has not received data is shown nothing.

Icon definition in the lower-left corner: Room temperature  ; External temperature  ; Combined temperature  ; Setpoint temperature .

When display actual temperature, switch automatically to setpoint temperature when adjust via the button, the adjustment step is 0.5K or 1K, which is configured via ETS. Exit the setting after finishing setpoint temperature adjustment, and display actual temperature.

When the setpoint temperature unit is set to degrees Celsius(°C), adjustment range of the setpoint temperature is 16~32°C by default; when the setpoint temperature unit is set to Fahrenheit(°F), the current temperature value will automatically convert to Fahrenheit value, adjustment range of the setpoint temperature is 60~89°F by default. The temperature adjustment range can be modified through parameter setting.



⑤This area displays humidity. It is configured via ETS.

⑥This area displays fan speed level, switch circularly via short press the button:

 Off,  Low,  Middle,  High,  Auto.

Display  as default when fan speed is uncertain.

⑦This area displays vanes swing status, it is enabled in ETS, switch via long press the button:

Stop , Swing ; Display  as default when vanes swing status is uncertain.

### 7.2.3.Floor heating page

Button operations as follow:

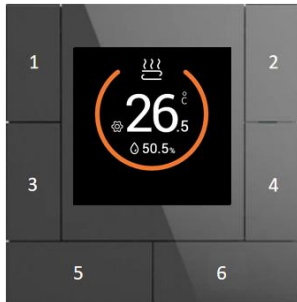

Button1	Press to power off	Button2	if enable multiple functions, press to switchover function page
Button3	NA	Button4	NA
Button5	press to decrease temperature	Button6	press to increase temperature

Page as follow:

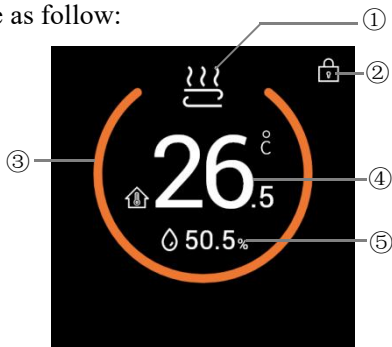

Fig.7.2.3(1)



Fig.7.2.3(2)

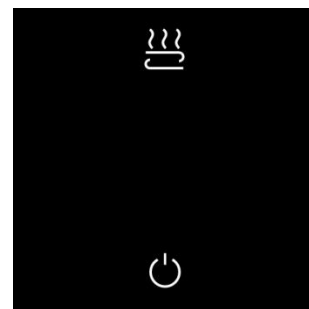



Fig.7.2.3(3)

When device is on, display the temperature and humidity, heating status and other status, according to the ETS configuration. When it is off, function interface is shown as Fig.7.2.3(3).

①This area displays function page icon. Icon is configured via ETS.

②This area displays locked status of function page, display  when locked, as shown as Fig.7.2.3(1).

The locked function page cannot be operated except receiving telegram from the bus. The locked is only apply to the current function page, and has no effect on switching between each function page. You can lock or unlock the function page via the bus.

③This ring is indicated the current heating status, different colour is different heating status. As shown as Fig.7.2.3(1), Fig.7.2.3(2):





Orange: heating valve on; White: heating valve off, at this time, floor heating is in the unheated status.



Floor heating compares the setpoint temperature with actual temperature of current environment to define control value according to 2-point control or PI control mode, so that realizes the automatic opening or closing of the heating valve.

**④This area displays setpoint temperature or actual temperature, which is configured via ETS.**

**Actual temperature has not received data is shown nothing.**

Icon definition in the lower-left corner: Room temperature  ; External temperature  ; Combined temperature  ; Setpoint temperature .

When display actual temperature, switch automatically to setpoint temperature when adjust via the button, the adjustment step is 0.5K or 1K, which is configured via ETS. Exit the setting after finishing setpoint temperature adjustment, and display actual temperature.

When the setpoint temperature unit is set to degrees Celsius(°C), adjustment range of the setpoint temperature is 16~32°C by default; when the setpoint temperature unit is set to Fahrenheit(°F), the current temperature value will automatically convert to Fahrenheit value, adjustment range of the setpoint temperature is 60~89°F by default. The temperature adjustment range can be modified through parameter setting.

**⑤This area displays humidity. It is configured via ETS.**

**7.2.4. Ventilation page**

Button operations as follow:



Button1	Press to power off	Button2	if enable multiple functions, press to switchover function page
Button3	press to switch heat recovery status	Button4	short press to switch auto status; long press 1s to reset filter time, long press 3s to exit filter alarm
Button5	press to decrease fan speed level	Button6	press to increase fan speed level

**Note: the time of long operation is not configured on General interface.**

Page as follow:

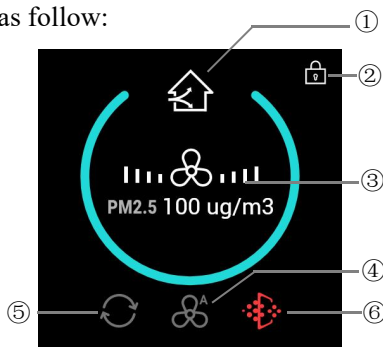

Fig.7.2.4(1)



Fig.7.2.4(2)

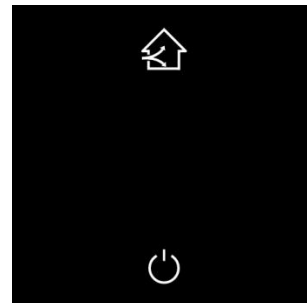



Fig.7.2.4(3)

When device is on, display the heat recovery, fan speed, filter and other status, according to the ETS configuration. When it is off, function interface is shown as Fig.7.2.4(3).

**①This area displays function page icon. Icon is configured via ETS.**

**②This area displays locked status of function page, display  when locked, as shown as Fig.7.2.4(1).**

The locked function page cannot be operated except receiving telegram from the bus. The locked is only apply to the current function page, and has no effect on switching between each function page. You can lock or unlock the function page via the bus.

③ This area displays according to auto status. Short press the button to switch auto status;



④ This area displays auto fan speed icon  when it is in auto status; And not display when exit auto;



When it is in auto status, display fan speed and the information of linked air quality (CO2/PM2.5/VOC), as shown as Fig.7.2.4(1).

When it exits auto status, display fan speed, the levels are reflected by the number of steps on both sides, as shown as Fig.7.2.4(2). Switch circularly via short press the button:

 Low;  Middle;  High.

Whether fan speed auto control is enable or not is configured through parameter configuration, when disabled, no display auto fan speed in ④ area, and always display fan speed in ③ area; When auto is enabled and in the auto status, automatic cyclic display of fan speed levels: low/middle/high.

⑤ This area displays status of heat recovery, switch via short press the button: heat recovery on , heat recovery off .

⑥ This area displays filter life of ventilation. Display  when filter is normal; Display  when filter life has been used up.

The service life of the filter set by the parameter configuration, or updated via the bus. When the filter time reaches to the parameter setting value, the alarm status can be issued through the bus to remain user to change filter, as well as reset the filter time. Exit alarm via long press the button 3s or via the object.

### 7.3. Audio control page

Button operations as follow:



Button1	short press to switch power on/off, long press to switch play mode	Button2	short press to switch play/pause, long press to mute
Button3	press to switch previous track	Button4	press to switch next track
Button5	short press to decrease volume, long press to decrease volume via relative/absolute way, the step value is determined by the parameter	Button6	short press to increase volume, long press to increase volume via relative/absolute way, the step value is determined by the parameter

**Note: the time of long operation is configured on General interface. When relative adjustment, the volume is not fed back to display on the screen after long operation.**

Page as follow:



Fig.7.3(1)

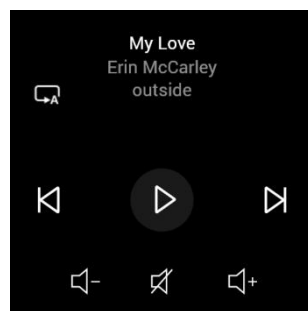
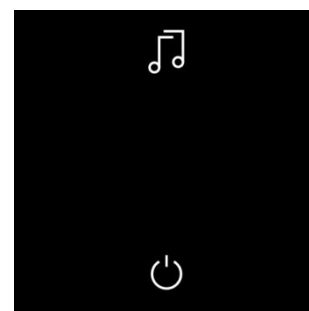



Fig.7.3(2)



When device is on, display the play status, play mode, volume, mute, track name, album name, artist name and other status, according to the ETS configuration. When it is off, function interface is shown as Fig.7.3(2).

①This area displays locked status of function page, display  when locked, as shown as Fig.7.3(1).

The locked function page cannot be operated except receiving telegram from the bus. You can lock or unlock the function page via the bus.

- ② This area displays track name, receive the track name via the bus;
- ③ This area displays artist name, receive the track name via the bus;
- ④ Select previous song by the button corresponding to this icon;
- ⑤ Select next song by the button corresponding to this icon;
- ⑥ This area displays the status of play/pause, switch via the button;
- ⑦ This area displays album name, receive the track name via the bus;
- ⑧ This area displays the play mode, switch circularly via the button: single cycle, random, playlist cycle;
- ⑨ This area displays volume, decrease volume via the button;
- ⑩ This area displays volume, increase volume via the button;
- ⑪ This area displays the volume or mute, you can choose to mute or cancel mute via the button. It display mute icon when in mute status, as shown as Fig.7.3(2).

**Note:** the volume on the screen ⑪ will be not change with the button operation of volume decrease/increase, only when a telegram is fed back on the bus can be updated.

## 7.4. Screen saver



Fig.7.4(1)

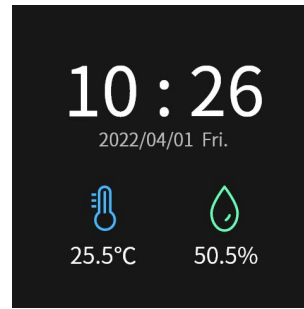

Fig.7.4(2)

Screen-saver can be set the date format and air quality information via the parameters on ETS.

The date and time can be modified on the setting page, or through the bus.

When air quality information is not configured, as shown as Fig.7.4(1); When air quality information is configured, as shown as Fig.7.4(2), up to 2 items to display.

When no operation on the screen and the delay time of screen-saver set by parameter arrives, screen will enter the screen-saver state; once an operation happened, it will exit screen saver.

## 7.5. Setting page

Button operations as follow:

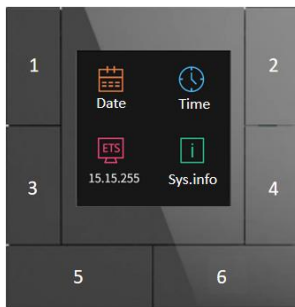

Press the upper right corner + lower left corner button ( button2 + button5 ) at the same time for 5s to enter the setting page, as shown as Fig.7.5(1).

Button1	Press to enter into date adjustment interface	Button2	Press to enter into time adjustment interface
Button3	press to active/inactive programming mode status	Button4	press to view system information of device
Button5	press to return to previous	Button6	press to exit setting page

**Note: the time of long operation is configured on General interface.**

Page as follow:

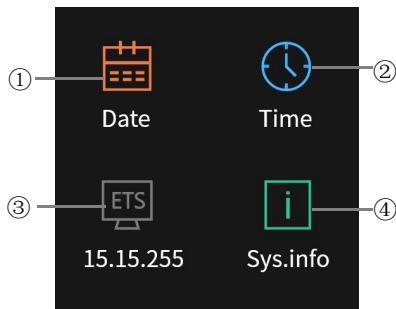

Fig.7.5(1)



Fig.7.5(2)



Fig.7.5(3)

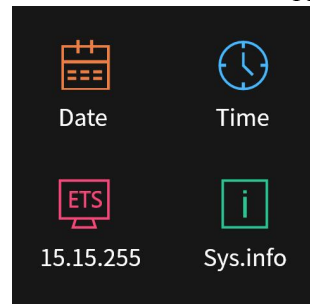

Fig.7.5(4)



Fig.7.5(5)

① Press the button corresponding to this icon, enter the time setting page as shown as Fig.7.5(2);

Increase/Decrease the number via the button 1~6. At this time, return the previous page via long pressing the button5, and exit the setting page via long press the button6.

② Press the button corresponding to this icon, enter the date setting page as shown as Fig.7.5(3);

Increase/Decrease the number via the button 1~4.

③ Press the button corresponding to this icon, enter the programming mode, as shown as Fig.7.5(4), and exit programming mode when press the button again.

④ Press the button corresponding to this icon, enter the page of system information, as shown as Fig.7.5(5), you can view firmware, database version, SN code, FDSK code;

The FDSK code is used for KNX secure, detail please refer to chapter 5.1.

## 7.6. Other

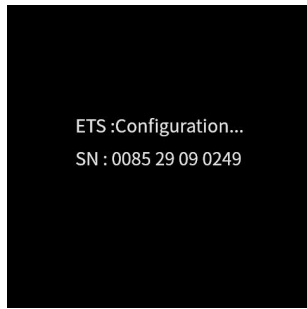

Fig.7.6(1)

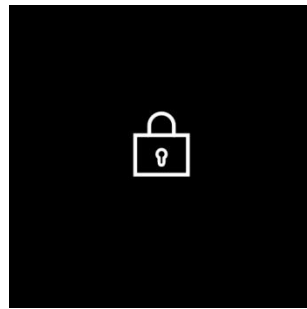

Fig.7.6(2)

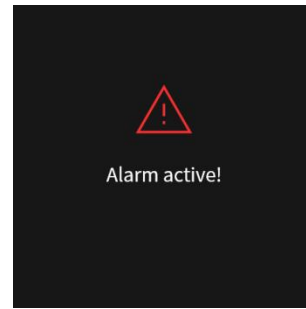

Fig.7.6(3)

1. When no application, the application download of the device is completed or the device power recover, the device will be initialized, as shown as Fig.7.6(1), you can view the SN code.

2. When it is downloading, lock the whole panel, as shown as Fig.7.6(2).











3. User can lock or unlock the operating interface of the device via the bus. After locking, interface shown as Fig.7.6(2), the entire device cannot be operated, except receiving telegram from the bus.

























4. Alarm function is activated by the receiving telegram from the bus, pup up the window shown as Fig.7.6(3) when activated, and with the alarm sound. Indicate text, the alarm tone time period and the automatically repeat interval time are set by the parameters.







































## Chapter 8 Icon list

### 8.1. Icon list for push button sensor







ETS options	Icon	ETS options	Icon
Light on		General scene 3	
Light off		Curtain	
Ceiling light		Blind(open/close)	
Downlight		Blind(up/down)	
Wall light		Blind(with slat)	
Spotlight		Blind open	
Chandelier		Blind close	
Floor light		Arrow up	
RGB lamp		Arrow down	
General scene 1		Plus	
General scene 2		Minus	

ETS options	Icon	ETS options	Icon
Brighter		Media	
Darker		Cleaning	
Go home 1		Comfort	
Leave home 1		Standby	
Go home 2		Economy	
Leave home 2		Protection	
Welcome		Wake up	
Meeting(guest)		TV	
Dinner		Socket(CHN)	
Party		Socket(EU)	
Sleeping		Fan	
Reading		Door lock	

ETS options	Icon	ETS options	Icon
Power supply		Windspeed	
Window 1		Rain	
Window 2		Current	
Alarm		Voltage	
Heating		Power meter	
Cooling		Presence	
Temperature		On	
Colour temperature		Off	
VOC		Open	
CO2		Close	
Humidity		Power on/off	
Brightness		Unlock	

ETS options	Icon	ETS options	Icon
Lock		Text	
No charge		Message	
Charge		Setting	
No mute		Room temperature	
Mute		PM2.5	
Day		PM10	
Night			

**8.2. Icon list for multifunction thermostat**

ETS options	Icon	ETS options	Icon
Air conditioner		Heating	
Floor heating		Cooling	
Water heating		Heating/Cooling system	
Ventilation system		Temperature	